

**30**  
1992 - 2022

Aquagrif S.L.  
Tel. (+34) 934 744 546  
Fax. (+34) 934 744 296  
Barcelona, Spain  
info@aquagrif.com  
www.aquagrif.com

CG03

 AQG CATÁLOGO GENERAL / GENERAL CATALOGUE / CATALOGUE GÉNÉRAL / CATALOGO GENERALE  CG03

 AQG

**30**  
1992 - 2022



**CATÁLOGO GENERAL  
GENERAL CATALOGUE  
CATALOGUE GÉNÉRAL  
CATALOGO GENERALE**





QB pg. 16



Delta pg. 26



Tube  
Colors: ■ □ pg. 36

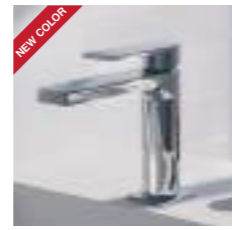

Alpha  
Colors: ■ □ pg. 52



Bold  
Colors: ■ pg. 74



Beta  
Colors: ■ pg. 88



Vent-i2 pg. 98



Lile pg. 106



Sky pg. 112



Salt pg. 118



Base pg. 120

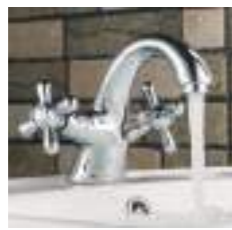

Bristol pg. 121



Sistemas de ducha monomando  
Single lever mixer shower systems  
Systèmes de douche avec mitigeur  
Sistemi di doccia con miscelatore  
Colors: ■ □ pg. 124



Sistemas de baño y ducha monomando  
Single lever mixer shower and bath systems  
Systèmes de baignoire et douche mitigeur  
Sistemi di vasca e doccia miscelatori  
Colors: ■ pg. 142



Sistemas de ducha termostáticos  
Thermostatic mixer shower systems  
Systèmes de douche thermostatiques  
Sistemi di doccia termostatici  
Colors: ■ □ pg. 148



Sistemas de baño y ducha termostáticos  
Thermostatic mixer shower and bath systems  
Systèmes de baignoire et douche thermostatiques  
Sistemi di doccia e vasca termostatici  
Colors: ■ pg. 168



Sistemas de ducha y baño sin grifería  
Shower and bath systems without mixer  
Systèmes de douche et baignoire sans robinetterie  
Sistemi di doccia e vasca senza rubinetteria  
pg. 172



Con rociador Flow  
With Flow shower head  
Avec douche de tête Flow  
Con soffione Flow  
pg. 176



Con rociador de pared  
With wall shower head  
Avec douche de tête murale  
Con soffione a parete  
Colors: ■ □ pg. 180



Con rociador de techo  
With ceiling shower head  
Avec douche de tête plafond  
Con soffione a soffitto  
Colors: ■ □ pg. 180



Con caño para bañera  
With bathtub spout  
Avec bec de baignoire  
Con getto di vasca  
pg. 196



Escade pg. 200



Sigma pg. 202



Quark pg. 203

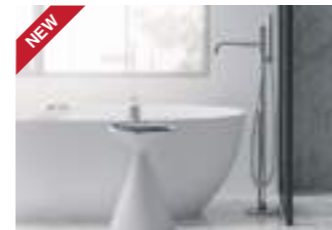

Minimalista  
Colors: ■ pg. 206



Bold pg. 208



Edna pg. 210



Onna pg. 212



Rio pg. 214



Noir pg. 208



Rociadores y brazos  
Shower heads & shower arms  
Douches de tête et bras pour  
douche de tête  
Soffioni doccia e bracci per doccia  
pg. 222

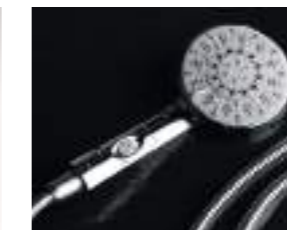

Mangos de ducha  
Hand showers  
Douchettes  
Doccette  
pg. 230

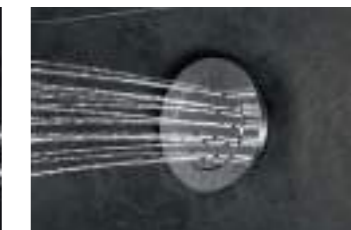

Jets  
Jets  
Jets  
Getti  
pg. 238



Conjuntos de ducha  
Shower bar Kits  
Ensembles de douche  
Insieme doccia  
pg. 240



Sets de ducha  
Shower sets  
Kits de douche  
Kit doccia  
pg. 243

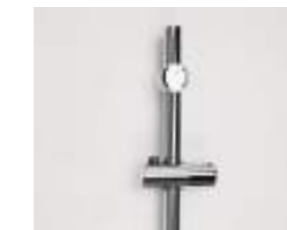

Barras  
Sliding bar  
Barres de douche  
Barre di doccia  
pg. 244



Soportes y tomas de agua  
Wall brackets and water  
outlets Supports muraux et  
prises d'eau  
Supporti a parete e prese  
d'acqua  
pg. 246



Flexos  
Flexible hoses  
Flexibles  
Flessibili  
pg. 248



**Kits para sustituir el bidet**  
Kits to replace the bidet  
Kits d'hygiène pour remplacer le bidet  
Kit igienici per sostituire il bidet

pg. 252

Colors: ■



**Conjuntos higiénicos**  
Hygienic sets  
Kits hygiéniques  
Set igienici

pg. 256

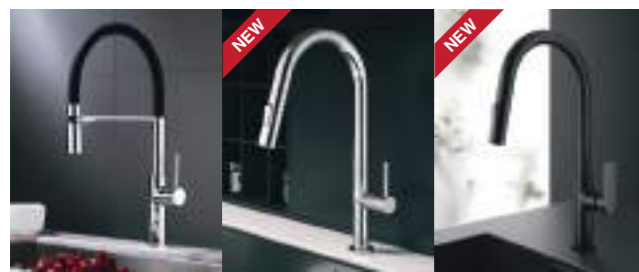

**Grifería de cocina**  
Kitchen faucets  
Robinetterie de cuisine  
Rubinetteria da cucina

pg. 260

Colors: ■ □



**Filtración y tratamiento de agua**  
Water filtration and treatment  
Système de filtration et traitement de l'eau  
Filtrazione e trattamento delle acque

pg. 288



**Grifería electrónica**  
Electronic faucets  
Robinetterie électronique  
Rubinetto elettronico

pg. 292

Colors: ■ □



**Grifería medical**  
Medical faucet  
Robinetterie Medical  
Rubinetto medico

pg. 296



**Grifos pedal**  
Foot valves  
Robinetterie à pédale  
Rubinetteria a pedale

pg. 297



**Grifo de jardín**  
Garden faucet  
Robinet de jardin  
Rubinetto da giardino

pg. 297



**Sifones**  
Waste traps  
Siphons  
Sifoni

pg. 290

Colors: ■ □



**Válvulas clic-clac**  
Waste valves  
Bondes clic-clac  
Valvole di scarico

pg. 290

Colors: ■ □



**Llaves de escuadra**  
Angle valves  
Prises d'eau  
Prese d'acqua

pg. 290



**Aireadores**  
Aerators  
Aérateurs  
Aeratori

pg. 290



**Jaboneras de rejilla**  
Shower baskets  
Étagères de douche  
Mensole per doccia

pg. 306

Colors: ■



**Asideros y barras de apoyo**  
Grab bars and support bars  
Poignées et barres de maintien  
Appigli e maniglie a cinghia

pg. 314



**Portatoallas Emma**  
Wall towel rack Emma  
Porte-serviettes Emma  
Portasciugamani Emma

pg. 316



**Complementos para muebles**  
Furniture complements  
Accessoires pour meubles  
Accessori per mobili

pg. 316

Colors: ■



**Accesorios de fijar**  
Fixing accessories  
Accessoires pour meubles  
Accessori per mobili

pg. 316



**Asientos**  
Shower seats  
Sièges de douche  
Sedili per la doccia

pg. 323



**Grifería electrónica**  
Electronic faucets  
Robinetterie électronique  
Rubinetto elettronico

pg. 292

Colors: ■ □



**Grifería medical**  
Medical faucet  
Robinetterie Medical  
Rubinetto medico

pg. 296



**Grifos pedal**  
Foot valves  
Robinetterie à pédale  
Rubinetteria a pedale

pg. 297



**Grifo de jardín**  
Garden faucet  
Robinet de jardin  
Rubinetto da giardino

pg. 297



**Sifones**  
Waste traps  
Siphons  
Sifoni

pg. 290

Colors: ■ □



**Válvulas clic-clac**  
Waste valves  
Bondes clic-clac  
Valvole di scarico

pg. 290

Colors: ■ □



**Llaves de escuadra**  
Angle valves  
Prises d'eau  
Prese d'acqua

pg. 290



**Aireadores**  
Aerators  
Aérateurs  
Aeratori

pg. 290



**Expositores de sobremesa**  
Desktop display  
Présentoir pour robinets  
Espositore rubinetti

pg. 348

**Expositores para grifería**  
Displays for faucets  
Présentoir pour robinets  
Espositore rubinetti

pg. 350

**Panel expositor**  
Display panel  
Présentoir  
Pannello espositore

pg. 351

**Expositor con ganchos**  
Display with hooks  
Présentoir avec crochets  
Espositore con ganci

pg. 349



**Sistema de baño y ducha Bel**  
Bel bath and shower system  
Système de baignoire et douche Bel  
Sistema di vasca e doccia Bel

pg. 142



**Monomando fregadera Sort con ducha extraíble**  
Sort single lever pull-out kitchen faucet  
Mitigeur d'évier Sort avec douchette  
Miscelatore per lavello Sort con doccetta

pg. 261



**Grifería QB**  
QB faucets  
Robinetterie QB  
Rubinetteria QB

pg. 16



**Sistema de baño y ducha Nite**  
Nite bath and shower system  
Système de baignoire et douche Nite  
Sistema di vasca e doccia Nite

pg. 146



**Grifería de suelo para bañera Minimalista**  
Minimalista freestanding bathtub  
Robinetterie sur pied pour Minimalista  
Rubinetteria a pavimento per vasca Minimalista

pg. 206

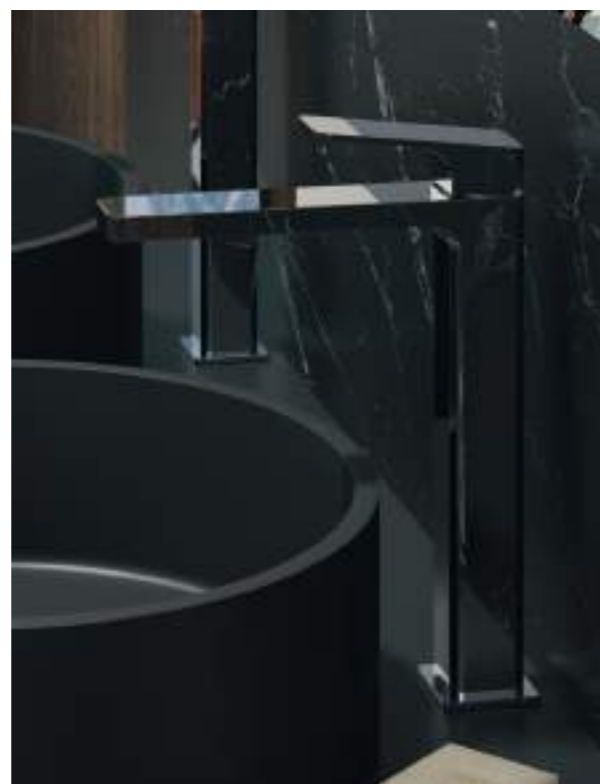

**Grifería Delta**  
Delta faucets  
Robinetterie Delta  
Rubinetteria Delta

pg. 26

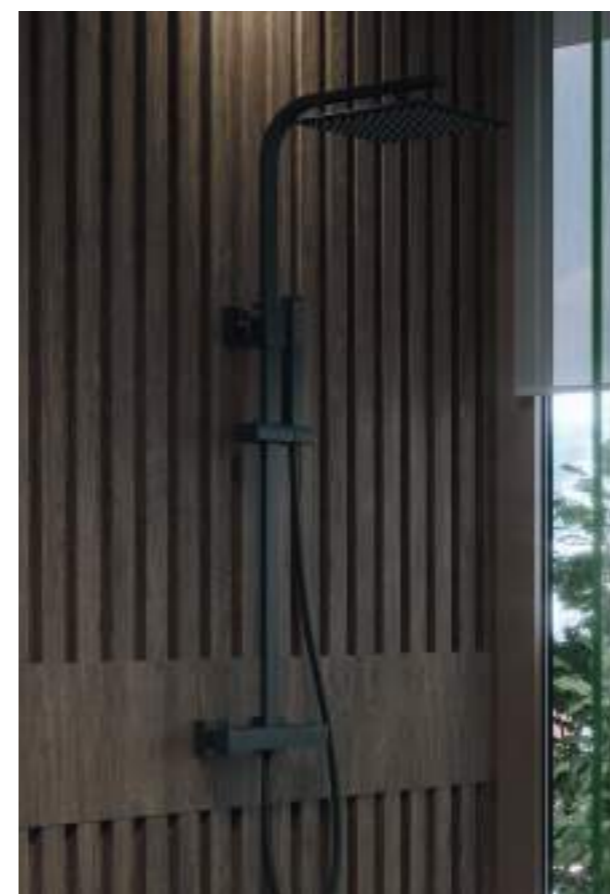

**Sistema de ducha Qus**  
Qus shower system  
Système de douche Qus  
Sistema doccia Qus

pg. 160



**Grifería de suelo para bañera Bold**  
Bold freestanding bathtub  
Robinetterie sur pied pour Bold  
Rubinetteria a pavimento per vasca Bold

pg. 208



**Sistema de ducha Nite**  
Nite shower system  
Système de douche Nite  
Sistema doccia Nite

pg. 140



**Kit para sustituir el bidet Ares**  
Kit to replace the bidet Ares  
Kit d'hygiène pour remplacer le bidet Ares  
Kit igienici per sostituire il bidet Ares

pg. 252



**Grifería Bold**  
Bold faucets  
Robinetterie Bold  
Rubinetteria Bold

pg. 82



**Sistema de ducha Qus**  
Qus shower system  
Système de douche Qus  
Sistema doccia Qus

pg. 134



**Grifería electrónica**  
Electronic faucets  
Robinetterie électronique  
Rubinetteria elettronica

pg. 292



**Grifería Alpha**  
Alpha faucets  
Robinetterie Alpha  
Rubinetteria Alpha

pg. 68



**Kit de empotrar Bold**  
Bold concealed shower set  
Ensemble à encastrer Bold  
Insieme da incasso Bold

pg. 188



**Toallero lateral Hok**  
Lateral towel bar Hok  
Porte-serviette latéral Hok  
Portasciugamani laterale Hok

pg. 316

	<b>Novedad</b> New products Nouveautés Novità		<b>Latiguillos con certificado AENOR</b> AENOR certified connecting hoses Flexibles avec certificat AENOR Flessibile con certificato AENOR
	<b>Grifería con cartucho de dos posiciones</b> Faucets with two positions cartridge Robinetterie avec cartouche deux positions Rubinetteria con cartuccia due posizioni		<b>Acorde a especificaciones norma Breeam</b> In accordance with Breeam rule Conforme aux spécifications de la norme Breeam Secondo le specifiche standard Breeam
	<b>Grifería con cartucho apertura en frío</b> Tap with cold water opening cartridge Robinet avec cartouche ouverture froide Rubinetto con cartuccia ad apertura fredda		<b>Grifería con cartucho apertura en frío</b> Tap with cold water opening cartridge Robinet avec cartouche ouverture froide Rubinetto con cartuccia ad apertura fredda
	<b>Diámetro de cartucho</b> Cartridge diameter Diamètre de la cartouche Diametro della cartuccia		<b>Ahorro de agua</b> Water saving Économie d'eau Risparmio idrico
	<b>Imantado</b> Magnetized Magnétisé Magnetizzato		<b>Número de funciones</b> Number of functions Nombre de fonctions Numero di funzioni
	<b>Producto en acero inoxidable AISI304</b> AISI304 stainless steel product Produit en acier inoxydable AISI304 Prodotto in acciaio inossidabile AISI304		<b>Con soporte</b> With support Avec support Con supporto
	<b>Grifería de cocina premium de acero inoxidable AISI304</b> Premium kitchen faucet stainless steel AISI 304 Robinetterie de cuisine en acier inoxydable AISI304 Rubinetteria da cucina in acciaio inossidabile AISI 304		<b>Mango de ducha con botón para cambiar de función</b> Hand shower with button to change function Douchette avec bouton pour changer les positions Doccetta con pulsante per cambiare posizione
	<b>Grifería electrónica</b> Electronic faucets Robinetterie électronique Rubinetto elettronico		<b>Ultrafino</b> Ultraslim Ultrafin Ultrafine
	<b>Stop de seguridad</b> Safety stop Arrêt de sécurité Sosta di sicurezza		<b>Función mango de ducha</b> Hand shower function Fonction douchette Funzione doccetta
	<b>Aireador antivandálico</b> Antivandalic aerator Aérateur anti-vandalisme Aeratore antivandalo		<b>Función lluvia (rociador)</b> Rain function (shower head) Fonction pluie (douche de tête) Funzione a pioggia (soffione)
	<b>Unidades por caja</b> Units per box Unités par boîte Unità per scatola		<b>Función cascada (rociador)</b> Rainfall function (shower head) Fonction cascade (douche de tête) Funzione cascata (soffione)
	<b>Diámetro</b> Diameter Diamètre Diametro		<b>Función caño</b> Spout function Fonction tuyau Funzione spruzzo
	<b>Altura</b> Height Hauteur Altezza		<b>Función jets</b> Jets function Fonction jets Funzione getti
	<b>Longitud</b> Length Longueur Lunghezza		<b>Consumo de agua para beber</b> Water consumption for drinking Consommation d'eau à boire Consumo di acqua da bere
	<b>Dimensiones</b> Dimensions Dimensions Dimensioni		<b>Consumo de agua para cocinar</b> Water consumption for cooking Consommation d'eau à cuisiner Consumo di acqua di cottura
	<b>Z class</b> 11,0 l/min		<b>Testado a 25 bar de presión</b> Tested at 25 bar pressure Testé à une pression de 25 bar Testato a una pressione di 25 bar



**Caudal grifería lavabo: ≤ 5 l/min 3 bar**  
Single lever basin faucet flow rate: ≤ 5 l/min 3 bar  
Débit robinetterie de lavabo: ≤ 5 l/min 3 bar  
Portata rubinetteria da lavabo: ≤ 5 l/min 3 bar

**Caudal grifería cocina: ≤ 5 l/min 3 bar**  
Kitchen faucets flow rate: ≤ 5 l/min 3 bar  
Débit robinetterie de cuisine: ≤ 5 l/min 3 bar  
Portata rubinetteria da cucina: ≤ 5 l/min 3 bar

**Caudal mangos de ducha: ≤ 9 l/min 3 bar**  
Hand showers flow rate: ≤ 9 l/min 3 bar  
Débit douchettes: ≤ 9 l/min 3 bar  
Portata doccette: ≤ 9 l/min 3 bar

**Caudal rociador: ≤ 9 l/min 3 bar**  
Shower head flow rate: ≤ 9 l/min 3 bar  
Débit douche de tête: ≤ 9 l/min 3 bar  
Portata soffione: ≤ 9 l/min 3 bar

**AHORRO DE AGUA / WATER SAVING**  
ÉCONOMIE D'EAU / RISPARMIO ACQUA

2P

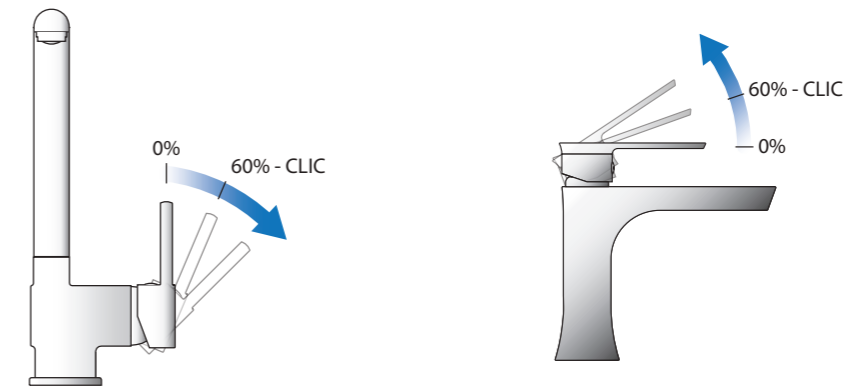

**El cartucho incorpora un sistema de dos posiciones que permite diferenciar entre la zona de caudal de bajo consumo y el caudal máximo. Al abrir la maneta para obtener más caudal, un tope ofrece una ligera resistencia para advertir que se pasa a la zona de máximo caudal.**

**A two position system is incorporated in the cartridge allowing to differentiate between the area of economic flow rate and the maximum flow rate. When the lever is raised to obtain more flow rate, there is a limit that offers a slight resistance and warns that it is in the area of maximum flow rate.**

**La cartouche intègre un système à deux positions qui fait la différence entre la zone de débit de faible puissance et le débit maximal. Lors de l'ouverture de la poignée pour plus de débit, un loquet offre une légère résistance pour vous avertir que vous entrez dans la zone de débit maximum.**

**La cartuccia incorpora un sistema a due posizioni che differenzia tra la zona di flusso a basso consumo e il flusso massimo. Quando si apre la maniglia per ottenere più flusso, un fermo offre una leggera resistenza per avvertire che si sta entrando nella zona di massimo flusso.**

**AHORRO DE ENERGÍA / ENERGY SAVING**  
ÉCONOMIE D'ÉNERGIE / RISPARMIO ENERGETICO

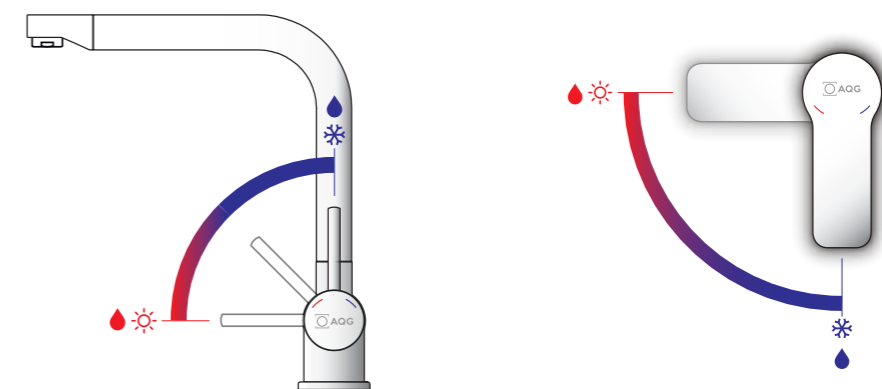

**Cuando se abre el grifo con la maneta en posición central sólo sale agua fría, evitando así la innecesaria puesta en marcha del calentador de agua con el consiguiente ahorro de energía. Si el usuario desea agua caliente deberá girar la maneta hasta obtener la temperatura deseada.**

**When you open the faucet with the lever in a central position the water that comes out is cold, avoiding the start-up of the water heater with the consequent saving of energy. If the user desires hot water will have to turn the lever counterclockwise until obtaining the temperature desired.**

**Lorsque vous ouvrez le robinet avec la poignée en position centrale, seule de l'eau froide sort, évitant ainsi le démarrage inutile du chauffe-eau, économisant ainsi de l'énergie. Si l'utilisateur veut de l'eau chaude, il doit tourner le bouton jusqu'à obtenir la température souhaitée.**

**Quando si apre il rubinetto con la maniglia in posizione centrale, fuoriesce solo acqua fredda, evitando così l'inutile avviamento dello scaldabagno, risparmiando così energia. Se l'utente vuole l'acqua calda, deve girare la manopola fino ad ottenere la temperatura desiderata.**

Nuestra grifería está certificada por el Ministerio de Industria y Energía de España y cumple con la norma europea UNE-EN-19703 (para grifería Monomando) y UNE-EN-19707 (para grifería Convencional). Esta certificación, según los reales decretos RD 358/85, RD 2200/95 y RD 411/97 es obligatoria para la comercialización de grifería sanitaria.

Our faucets are certified by the Ministry of Industry and Energy of Spain and comply with the European standard UNE-EN-19703 (for single lever mixers) and with the UNE-EN 19707 (for simple taps and mixer taps). This certification, according to the royal decrees RD 358/85, RD 2200/95 and RD 411/97, is mandatory for the marketing of sanitary tapware.

Nos robinets et mitigeurs sont certifiés par le Ministère espagnol de l'Industrie et de l'Énergie et ils sont conformes à la norme européenne UNE-EN-19703 (pour robinetterie monocommande) et UNE-EN-19707 (pour robinetterie classique).

Cette certification, par les décrets royaux RD 358/85, RD 2200/95 et RD 411/97 est obligatoire pour la commercialisation de robinetterie sanitaire.

I nostri rubinetti e miscelatori sono certificati dal Ministero dell'Industria e dell'Energia spagnolo e sono conformi allo standard europeo UNE-EN-19703 (per rubinetteria monocomando) e UNE-EN-19707 (per rubinetteria classica).

Questa certificazione, da regi decreti RD 358/85, RD 2200/95 e RD 411/97, è obbligatoria per la vendita di rubinetteria sanitaria.

## ¿QUE SIGNIFICA GRIFERÍA CERTIFICADA? ¿WHAT IS THE MEANING OF CERTIFIED FAUCET? QU'EST-CE QUE SIGNIFIE ROBINETTERIE CERTIFIÉE? COSA SIGNIFICA RUBINETTERIA CERTIFICATA?

A continuación se detallan algunos de los ensayos realizados en laboratorio necesarios para obtener la certificación de cada grifería.

Hereafter, a detail of some of the tests conducted in the laboratory necessary to obtain the certification of each mixer or tap.

Ci-dessous sont indiqués certains essais réalisés en laboratoire nécessaires pour obtenir la certification de chaque robinetterie.

Di seguito sono indicati alcuni test effettuati in laboratorio necessari per ottenere la certificazione di ogni rubinetto.

### ENSAYO DE RESISTENCIA A LA CORROSIÓN CORROSION RESISTANCE TEST ÉPREUVE DE RESISTANCE À LA CORROSION PROVA DI RESISTENZA ALLA CORROSIONE

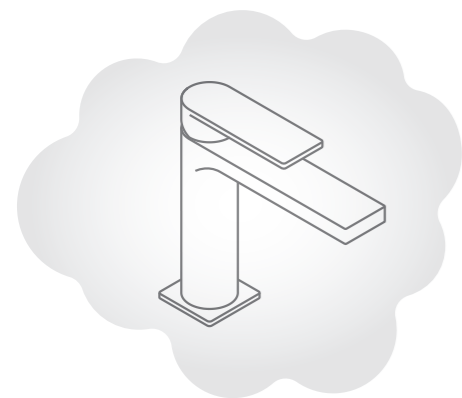

200 h  
5% NaCl

Ensayo de 200 horas en cámara de niebla salina (Se comprueba el comportamiento de los materiales de la grifería en un entorno de corrosión acelerada durante 9 días) con una solución salina al 5% NaCl (Cloruro de sodio) según norma: ISO 9227

200-hour test in salt spray chamber (the performance of the different faucet materials in an accelerated corrosive environment is checked during 9 days) with a saline solution at 5% NaCl (Sodium chloride) according to ISO 9227 standard.

Épreuve de 200 heures en chambre au brouillard salin (on vérifie le comportement des matériaux de la robinetterie dans un environnement de corrosion accélérée pendant 9 jours) avec une solution saline au 5% NaCl (chlorure de sodium) selon norme : ISO 9227.

Prova di 200 ore in camera a nebbia salina (verifichiamo comportamento dei materiali delle valvole in un ambiente di corrosione accelerata per 9 giorni) con soluzione salina al 5% NaCl (cloruro di sodio) secondo la norma: ISO 9227.

### ENSAYO DE CICLADO DEL CARTUCHO MECHANICAL ENDURANCE OF THE CARTRIDGE ENDURANCE MÉCANIQUE DE LA CARTOUCHE RESISTENZA MECCANICA DELLA CARTUCCIA

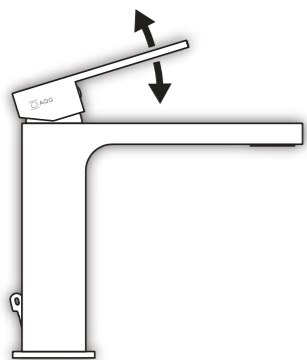

70.000  
operaciones / operations  
opérations / operazioni

Se efectúan sobre el cartucho de los monomandos 70.000 operaciones de apertura y cierre más giro de fría a caliente. Después del ensayo el cartucho debe funcionar correctamente.

Performed on the single lever cartridge: 70.000 open and close operations as well as turning from cold to hot. At the end of the test, the cartridge should perform correctly.

Ils sont réalisés sur la cartouche des monocommandes 70.000 opérations d'ouverture et de fermeture avec rotation d'eau froide à eau chaude. Après l'essai, la cartouche doit fonctionner correctement.

Test realizzati sulla cartuccia di monocomandi, 70.000 operazioni di apertura e chiusura con rotazione dall'acqua fredda all'acqua calda. Dopo il test, la cartuccia deve funzionare correttamente.

### ENSAYO DE CICLADO EN EL INVERSOR MECHANICAL ENDURANCE OF THE DIVERTER ENDURANCE MÉCANIQUE DU DÉVIATEUR RESISTENZA MECCANICA DEL DEVIATORE

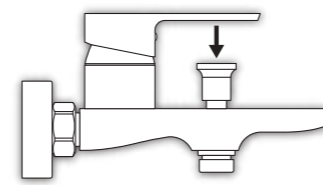

30.000  
operaciones  
operations  
opérations  
operazioni

Se somete el inversor de los baños-ducha a 30.000 operaciones de cambio de ducha a baño con agua corriente, después del ensayo el inversor debe funcionar correctamente.

The diverter of shower-bath faucets is subjected to 30.000 operations of switching from shower to bath position with running water. At the end of the test, the diverter should perform correctly.

L'inverseur mitigeur bain-douche est soumis à 30.000 opérations, qui consistent à changer la position de bain à douche avec de l'eau courante. Après l'essai, l'inverseur doit fonctionner correctement.

Test effettuati sul deviatore dei miscelatori per doccia-vasca, 30.000 operazioni di cambio tra la posizione della doccia e il bagno con acqua corrente. Dopo il test, il deviatore deve funzionare correttamente.

### ENSAYO DE CICLADO DEL SISTEMA DE GIRO DEL CAÑO MECHANICAL ENDURANCE OF THE SWIVEL SPOUT ENDURANCE MÉCANIQUE DU SYSTÈME DE ROTATION DU BEC RESISTENZA MECCANICA DEL SISTEMA DI ROTAZIONE DEL COLLO

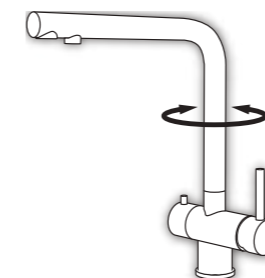

80.000  
operaciones  
operations  
opérations  
operazioni

Se realizan sobre el caño de los fregaderos 80.000 operaciones de giro de 90° con un peso de 1Kg. en la salida del caño. Después del ensayo el sistema de giro debe funcionar correctamente.

Performed on the swivel spout of the kitchen faucets: 80.000 operations of 90° rotation with a 1 kg weight at the spout outlet. At the end of the test, the swivel system should perform correctly.

Sur les becs des mitigeurs d'évier sont réalisées 80.000 opérations de rotation de 90° avec un poids de 1kg à la sortie du bec. Après l'essai, le système de rotation doit fonctionner correctement.

Test realizzati sui colli dei miscelatori per lavello, 80.000 operazioni di rotazione di 90° con un peso di 1kg all'uscita del collo. Dopo il test, il sistema di rotazione deve funzionare correttamente.

### COMPORTAMIENTO MECÁNICO BAJO PRESIÓN (Prueba de alta presión) MECHANICAL PERFORMANCE UNDER PRESSURE (High pressure test) ENDURANCE MÉCANIQUE SOUS PRESSION (Éssai de haute pression) RESISTENZA MECCANICA SOTTO PRESSIONE (Test alta pressione)



TESTED

25bar 60s

Se aplica a la grifería una presión durante un tiempo determinado. Después del ensayo no se deben apreciar ni fugas ni deformaciones.

The faucets are subject to a constant pressure for a certain period of time. At the end of the test there shall be no leakage nor deformation.

Une pression s'applique à la robinetterie pendant un temps déterminé. Après l'essai, aucunes fuites ni déformations ne doivent être appréciées.

Si applica al rubinetto una pressione per un certo tempo. Dopo il test, non devono essere apprezzate perdite o deformazioni.

### ENSAYOS DE ESTANQUEIDAD Y DE NO INTERCOMUNICACIÓN LEAK-TIGHTNESS TEST AND CROSS FLOW BETWEEN HOT AND COLD WATER ESSAIS D'ÉTANCHÉITÉ ET DE NON-INTERCOMMUNICATION PROVE DI TENUTA STAGNA E DI NON INTERCOMUNICAZIONI



TESTED

4bar 60s  
2bar 60s

Se comprueba que el producto no presente fugas a diferentes presiones y entre las diferentes cámaras con la salida cerrada artificialmente.

Verification that there are no leakages at different pressures in the products nor between the different chambers with the outlet closed artificially.

À différentes pressions et en fermant les chambres de manière artificielle, nous contrôlons que le produit ne présente aucune fuite pour chaque chambre.

Si controlla che il prodotto non presenti perdite a diverse pressioni e tra le diverse camere con l'uscita artificialmente chiusa.





**GRIFERÍA DE BAÑO**  
**BATHROOM FAUCETS**  
**ROBINETTERIE POUR SALLE DE BAIN**  
**RUBINETTERIA DA BAGNO**

# QB

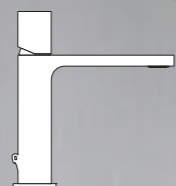

GRIFERÍA DE BAÑO  
BATHROOM FAUCETS  
ROBINETTERIE POUR SALLE DE BAIN  
RUBINETTERIA DA BAGNO

GRIFERÍA DE BAÑO  
BATHROOM FAUCETS





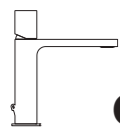

QB

GRIFERÍA DE BAÑO / BATHROOM FAUCETS  
ROBINETTERIE POUR SALLE DE BAIN / RUBINETTERIA DA BAGNO



**Monomando de lavabo 25, cromo**  
Single lever basin faucet 25, chrome  
Mitigeur de lavabo 25, chromé  
Miscelatore per lavabo 25, cromato

01QBE100CR 9,2 l/min 3 bar

01QBE108CR 5 l/min 3 bar

NEW

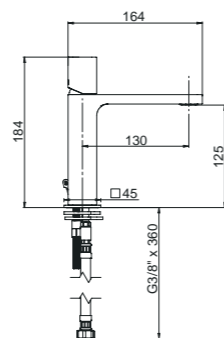

**Monomando de lavabo 35, cromo**  
Single lever basin faucet 35, chrome  
Mitigeur de lavabo 35, chromé  
Miscelatore per lavabo 35, cromato

01QBE110CR 12,5 l/min 3 bar

01QBE118CR 5 l/min 3 bar

NEW

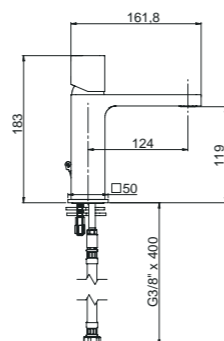

GRIFERÍA DE BAÑO  
BATHROOM FAUCETS



**QB**



**Monomando alto de lavabo, cromo**  
High single lever basin faucet, chrome  
Mitigeur de lavabo haut, chromé  
Miscelatore per lavabo alto, cromato

01QBE120CR 10 l/min 3 bar

01QBE128CR 5 l/min 3 bar

NEW

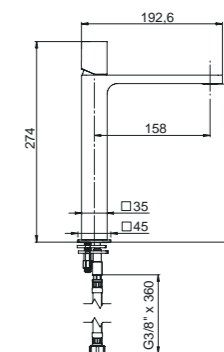

**Monomando de bidet, cromo**  
Single lever bidet faucet, chrome  
Mitigeur de bidet, chromé  
Miscelatore per bidet, cromato

01QBE200CR 7,3 l/min 3 bar

NEW

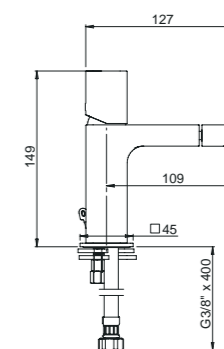

**Monomando de ducha, cromo**  
Single lever shower faucet, chrome  
Mitigeur de douche, chromé  
Miscelatore per doccia, cromato

**Sin equipo / Without equipment**  
Sans équipement / Senza equipaggiamento

01QBE300CR

**Con equipo P / With equipment P**  
Avec équipement P / Con equipaggiamento P

01QBE319CR 7,5 l/min 3 bar

NEW

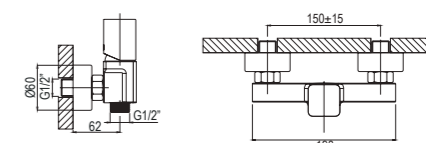

**Monomando de bañera, cromo**  
Single lever bath faucet, chrome  
Mitigeur de baignoire, chromé  
Miscelatore per vasca, cromato

**Sin equipo / Without equipment**  
Sans équipement / Senza equipaggiamento

01QBE400CR 13,3 l/min 3 bar

**Con equipo P / With equipment P**  
Avec équipement P / Con equipaggiamento P

01QBE419CR 7,9 l/min 3 bar

NEW

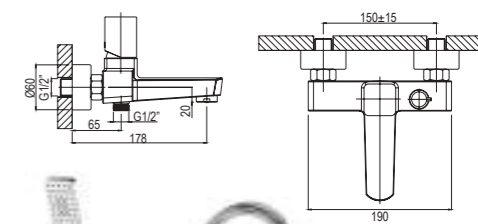



**Monomando de empotrar 1 vía, cromo**  
1 way concealed shower mixer, chrome  
Mitigeur à encastrer 1 voie, chromé  
Miscelatore da incasso 1 vía, cromato

01QB350CR

NEW

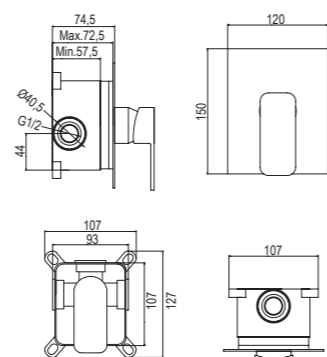

**Monomando de empotrar 2 vías, cromo**  
2 ways concealed shower mixer, chrome  
Mitigeur à encastrer 2 voies, chromé  
Miscelatore da incasso 2 vie, cromato

01QB351CR

NEW

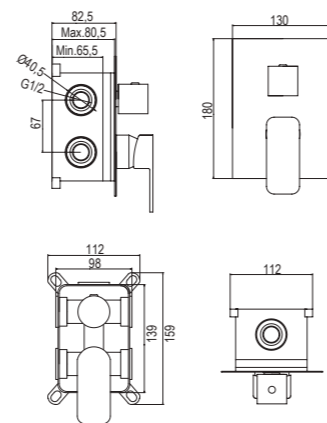

**Monomando de empotrar 3 vías, cromo**  
3 ways concealed shower mixer, chrome  
Mitigeur à encastrer 3 voies, chromé  
Miscelatore da incasso 3 vie, cromato

01QB352CR

NEW

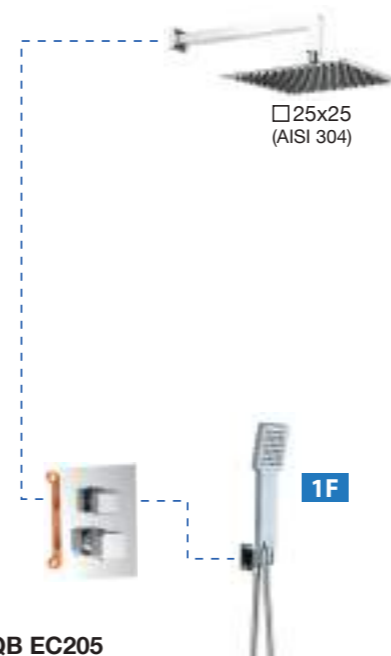
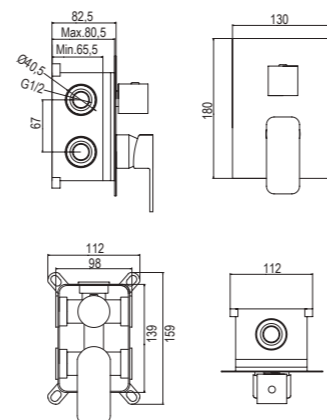

**KIT QB EC205**

**Monomando de empotrar con rociador y set de ducha**  
Concealed shower mixer with shower head and shower set  
Mitigeur à encastrer avec douche de tête et kit de douche  
Miscelatore da incasso con soffione attacco e kit doccia

19QBEEC20502

NEW



10,8 l/min 3 bar



14,5 l/min 3 bar



**KIT QB EC204**

**Monomando de empotrar con rociador y set de ducha**  
Concealed shower mixer with shower head and shower set  
Mitigeur à encastrer avec douche de tête et kit de douche  
Miscelatore da incasso con soffione attacco e kit doccia

19QBEEC20402

NEW



10,8 l/min 3 bar



14,5 l/min 3 bar



**OPCIONAL / OPTIONAL / OPTIONNEL / OPZIONALE**

**Kit 2 reductores caudal 9 l/min ducha/rociador**  
2 flow rate reducer kit 9 l/min hand shower/head shower  
Kit 2 réducteurs débit 9l/min douchette/douche de tête  
Kit 2 riduttori portata 9 l/min maniglia doccia/soffione

6024X2



9 l/min 3 bar



9 l/min 3 bar



**Sistema de ducha monomando**  
Single lever mixer shower system  
Système de douche mitigeur  
Sistemi di doccia miscelatori

- Monomando con distribuidor incorporado
- Barra extensible de acero inoxidable
- Flexo de acero inoxidable doble grapado, anti-torsión, 1,70 m

- Single lever mixer with integrated distributor
- Stainless steel extensible bar
- Stainless steel flexible shower hose double hooked, anti-twist, 1,70 m

- Mitigeur avec distributeur intégré
- Barre extensible en acier inoxydable
- Flexible en acier inoxydable double agrafage, anti-torsion, 1,70 m

- Miscelatore con distributore integrato
- Barra allungabile in acciaio inossidabile
- Flessibile di doppia aggraffatura in acciaio inossidabile, anti-torsione, 1,70 m

NEW

**OPCIONES DE ROCIADOR**  
SHOWER HEAD OPTIONS  
OPTIONS POUR DOUCHE DE TÊTE  
OPZIONI PER SOFFIONE

**Atlas C20**

en AISI 304  
in AISI304  
en AISI 304  
in AISI 304

20 x 20 cm

21LUC20QBL02



12,5 l/min 3 bar

**Atlas C25**

en AISI 304  
in AISI304  
en AISI 304  
in AISI 304

25 x 25 cm

21LUC25QBL02



12,5 l/min 3 bar



# DELTA

GRIFERÍA DE BAÑO  
BATHROOM FAUCETS  
ROBINETTERIE POUR SALLE DE BAIN  
RUBINETTERIA DA BAGNO







**DELTA**

**GRIFERÍA DE BAÑO / BATHROOM FAUCETS**  
ROBINETTERIE POUR SALLE DE BAIN / RUBINETTERIA DA BAGNO



**Monomando de lavabo 25, cromo**  
Single lever basin faucet 25, chrome  
Mitigeur de lavabo 25, chromé  
Miscelatore per lavabo 25, cromato

01DEL100CR 9,2 l/min 3 bar

01DEL108CR 5 l/min 3 bar

**NEW**

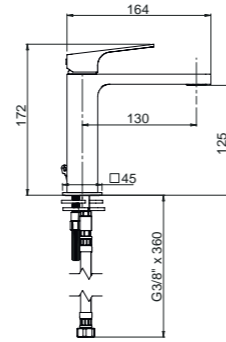

**Monomando de lavabo 35, cromo**  
Single lever basin faucet 35, chrome  
Mitigeur de lavabo 35, chromé  
Miscelatore per lavabo 35, cromato

01DEL110CR 12,5 l/min 3 bar

01DEL118CR 5 l/min 3 bar

**NEW**

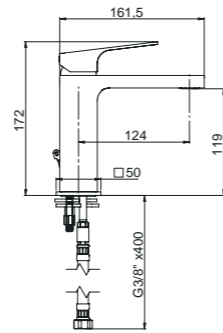

GRIFERÍA DE BAÑO  
BATHROOM FAUCETS





DELTA

GRIFERÍA DE BAÑO / BATHROOM FAUCETS  
ROBINETTERIE POUR SALLE DE BAIN / RUBINETTERIA DA BAGNO



**Monomando alto de lavabo, cromo**  
High single lever basin faucet, chrome  
Mitigeur de lavabo haut, chromé  
Miscelatore per lavabo alto, cromato

01DEL120CR 10 l/min 3 bar

01DEL128CR 5 l/min 3 bar

NEW

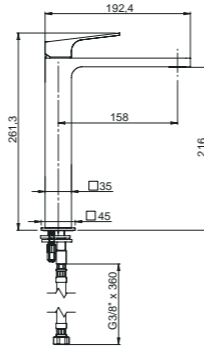

**Monomando de bidet, cromo**  
Single lever bidet faucet, chrome  
Mitigeur de bidet, chromé  
Miscelatore per bidet, cromato

01DEL200CR 7,3 l/min 3 bar

NEW

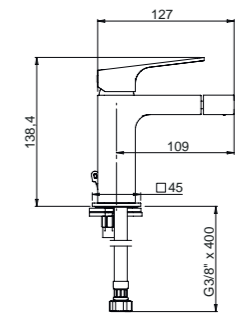

**Monomando de ducha, cromo**  
Single lever shower faucet, chrome  
Mitigeur de douche, chromé  
Miscelatore per doccia, cromato

**Sin equipo / Without equipment**  
Sans équipement / Senza equipaggiamento

01DEL300CR

**Con equipo P / With equipment P**  
Avec équipement P / Con equipaggiamento P

01DEL319CR 9,2 l/min 3 bar

NEW

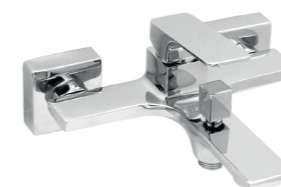
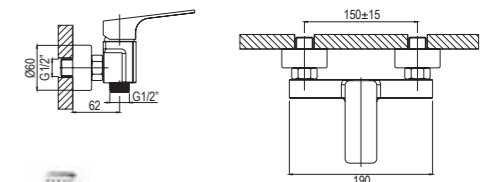

**Monomando de bañera, cromo**  
Single lever bath faucet, chrome  
Mitigeur de baignoire, chromé  
Miscelatore per vasca, cromato

**Sin equipo / Without equipment**  
Sans équipement / Senza equipaggiamento

01DEL400CR 18,3 l/min 3 bar

**Con equipo P / With equipment P**  
Avec équipement P / Con equipaggiamento P

01DEL419CR 7,5 l/min 3 bar

NEW

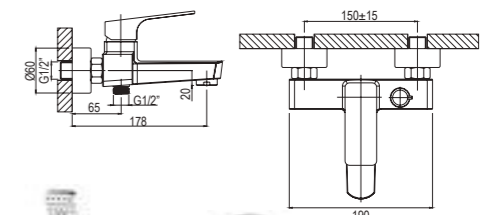



**Monomando de empotrar 1 vía, cromo**  
1 way concealed shower mixer, chrome  
Mitigeur à encastrer 1 voie, chromé  
Miscelatore da incasso 1 vía, cromato

01DEL350CR

NEW

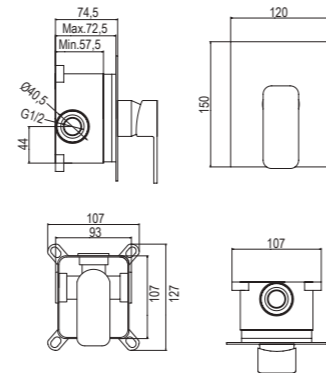

**Monomando de empotrar 2 vías, cromo**  
2 ways concealed shower mixer, chrome  
Mitigeur à encastrer 2 voies, chromé  
Miscelatore da incasso 2 vía, cromato

01DEL351CR

NEW

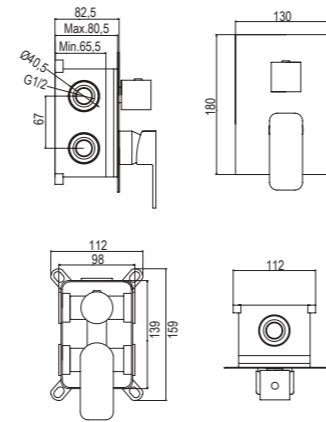

**Monomando de empotrar 3 vías, cromo**  
3 ways concealed shower mixer, chrome  
Mitigeur à encastrer 3 voies, chromé  
Miscelatore da incasso 3 vie, cromato

01DEL352CR

NEW

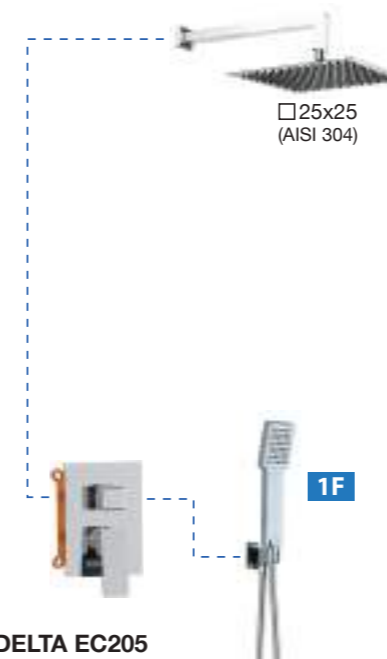
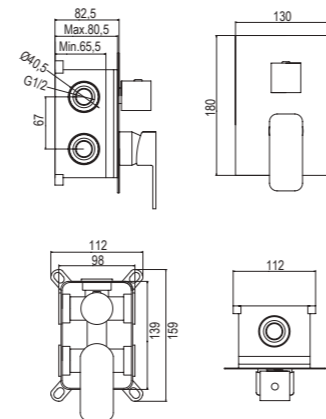

**KIT DELTA EC205**

**Monomando de empotrar con rociador y set de ducha**  
Concealed shower mixer with shower head and shower set  
Mitigeur à encastrer avec douche de tête et kit de douche  
Miscelatore da incasso con soffione attacco e kit doccia

19DELEC20502

NEW



10,8 l/min 3 bar



14,5 l/min 3 bar



**KIT DELTA EC204**

**Monomando de empotrar con rociador y set de ducha**  
Concealed shower mixer with shower head and shower set  
Mitigeur à encastrer avec douche de tête et kit de douche  
Miscelatore da incasso con soffione attacco e kit doccia

19DELEC20402

NEW



10,8 l/min 3 bar



14,5 l/min 3 bar



**OPCIONAL / OPTIONAL / OPTIONNEL / OPZIONALE**

**Kit 2 reductores caudal 9 l/min ducha/rociador**  
2 flow rate reducer kit 9 l/min hand shower/head shower  
Kit 2 réducteurs débit 9l/min douchette/douche de tête  
Kit 2 riduttori portata 9 l/min maniglia doccia/soffione

6024X2



9 l/min 3 bar



9 l/min 3 bar



**Sistema de ducha monomando**

Single lever mixer shower system  
Système de douche mitigeur  
Sistemi di doccia miscelatori

- Monomando con distribuidor incorporado
- Barra extensible de acero inoxidable
- Flexo de acero inoxidable doble grapado, antitorsión, 1,70 m

- Single lever mixer with integrated distributor
- Stainless steel extensible bar
- Stainless steel flexible shower hose double hooked, anti-twist, 1,70 m

- Mitigeur avec distributeur intégré
- Barre extensible en acier inoxydable
- Flexible en acier inoxydable double agrafage, anti-torsion, 1,70 m

- Miscelatore con distributore integrato
- Barra allungabile in acciaio inossidabile
- Flessibile di doppia aggraffatura in acciaio inossidabile, anti-torsione, 1,70 m

NEW

**OPCIONES DE ROCIADOR**  
SHOWER HEAD OPTIONS  
OPTIONS POUR DOUCHE DE TÊTE  
OPZIONI PER SOFFIONE

**Atlas C20**

en AISI 304  
in AISI304  
en AISI 304  
in AISI 304

20 x 20 cm

21LUC20DEL02



12,5 l/min 3 bar

**Atlas C25**

en AISI 304  
in AISI304  
en AISI 304  
in AISI 304

25 x 25 cm

21LUC25DEL02



12,5 l/min 3 bar



# TUBE

GRIFERÍA DE BAÑO  
BATHROOM FAUCETS  
ROBINETTERIE POUR SALLE DE BAIN  
RUBINETTERIA DA BAGNO



**Monomando de lavabo, cromo**  
Single lever basin faucet, chrome  
Mitigeur de lavabo, chromé  
Miscelatore per lavabo, cromato

01TUB100CR 9 l/min 3 bar

01TUB108CR 5 l/min 3 bar

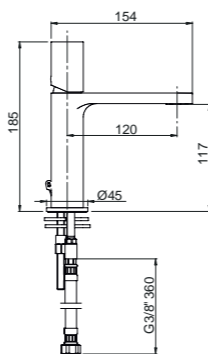

**Monomando alto de lavabo, cromo**  
High single lever basin faucet, chrome  
Mitigeur de lavabo haut, chromé  
Miscelatore per lavabo alto, cromato

01TUB120CR 10,4 l/min 3 bar

01TUB128CR 5 l/min 3 bar

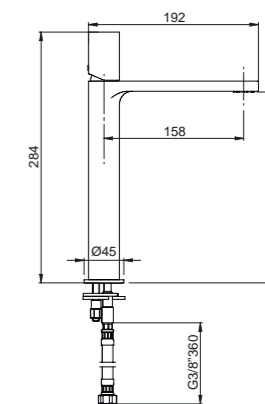

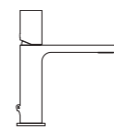

## TUBE

GRIFERÍA DE BAÑO / BATHROOM FAUCETS  
ROBINETTERIE POUR SALLE DE BAIN / RUBINETTERIA DA BAGNO



**Monomando de bidet, cromo**  
Single lever bidet faucet, chrome  
Mitigeur de bidet, chromé  
Miscelatore per bidet, cromato

01TUB200CR 8,3 l/min 3 bar

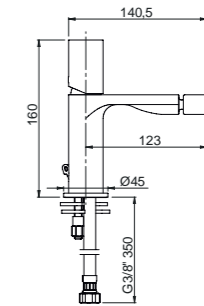

**Monomando de ducha, cromo**  
Single lever shower faucet, chrome  
Mitigeur de douche, chromé  
Miscelatore per doccia, cromato

**Sin equipo / Without equipment**  
Sans équipement / Senza equipaggiamento

01TUB300CR

**Con equipo I / With equipment I**  
Avec équipement I / Con equipaggiamento I

01TUB310CR 7,1 l/min 3 bar

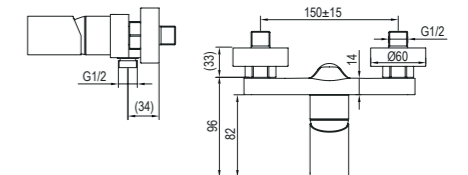

3F

170 cm.



**Monomando de bañera, cromo**  
Single lever bath faucet, chrome  
Mitigeur de baignoire, chromé  
Miscelatore per vasca, cromato

**Sin equipo / Without equipment**  
Sans équipement / Senza equipaggiamento

01TUB400CR 19,2 l/min 3 bar

**Con equipo I / With equipment I**  
Avec équipement I / Con equipaggiamento I

01TUB410CR 7,1 l/min 3 bar

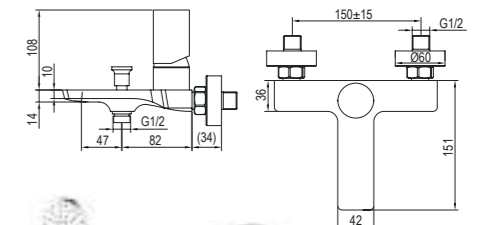

3F

170 cm.



**Monomando fregadera de caño muelle, cromo**  
Single lever kitchen faucet, spring spout, chrome  
Mitigeur d'évier, bec haut à ressort, chromé  
Miscelatore per lavello, collo alto à muelle, cromato

05COT500CR 8,3 l/min 3 bar

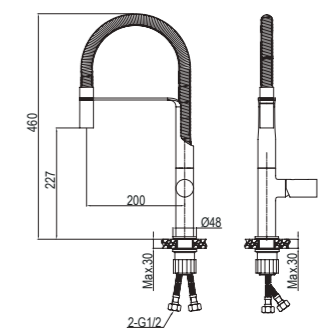

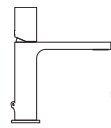

# TUBE

GRIFERÍA DE BAÑO / BATHROOM FAUCETS  
ROBINETTERIE POUR SALLE DE BAIN / RUBINETTERIA DA BAGNO



**Monomando fregadera de caño flexible negro, cromo**  
Single lever kitchen faucet, black flexible spout, chrome

Mitigeur d'évier, bec haut flexible noir, chromé  
Miscelatore per lavello, collo alto flessibile nero, cromato

05BCT500NC 6,3 l/min 3 bar

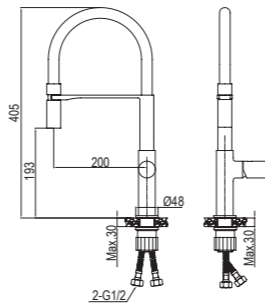

**Monomando de empotrar 1 vía, cromo**  
1 way concealed shower mixer, chrome  
Mitigeur à encastrer 1 voie, chromé  
Miscelatore da incasso 1 vía, cromato

01TUB350CR

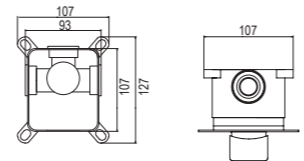
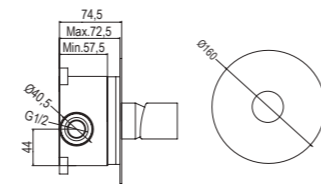

**Monomando de empotrar 2 vías, cromo**  
2 ways concealed shower mixer, chrome  
Mitigeur à encastrer 2 voies, chromé  
Miscelatore da incasso 2 vie, cromato

01TUB351CR

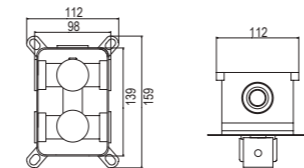
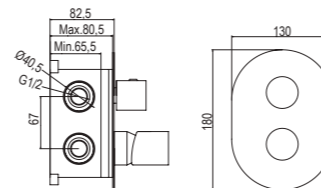

**Monomando de empotrar 3 vías, cromo**  
3 ways concealed shower mixer, chrome  
Mitigeur à encastrer 3 voies, chromé  
Miscelatore da incasso 3 vie, cromato

01TUB352CR

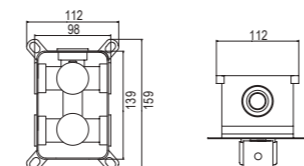
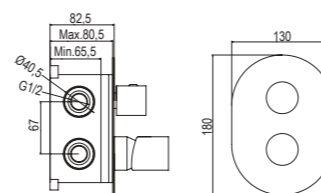

### KIT TUBE ER217

**Monomando de empotrar con rociador y set de ducha**  
Concealed shower mixer with shower head and shower set  
Mitigeur à encastrer avec douche de tête et kit de douche  
Miscelatore da incasso con soffione attacco e kit doccia

19TUBER21702

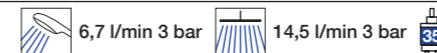

### KIT TUBE ER211

**Monomando de empotrar con rociador y set de ducha**  
Concealed shower mixer with shower head and shower set  
Mitigeur à encastrer avec douche de tête et kit de douche  
Miscelatore da incasso con soffione attacco e kit doccia

19TUBER21102

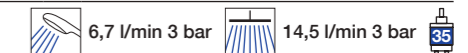

### OPCIONAL / OPTIONAL / OPTIONNEL / OPZIONALE

**Reductor caudal 9 l/min ducha/rociador**  
Flow rate reducer 9 l/min hand shower/shower head  
Réducteur débit 9 l/min douchette/douche de tête  
Riduttore portata da 9 l/min maniglia doccia/soffione

6024

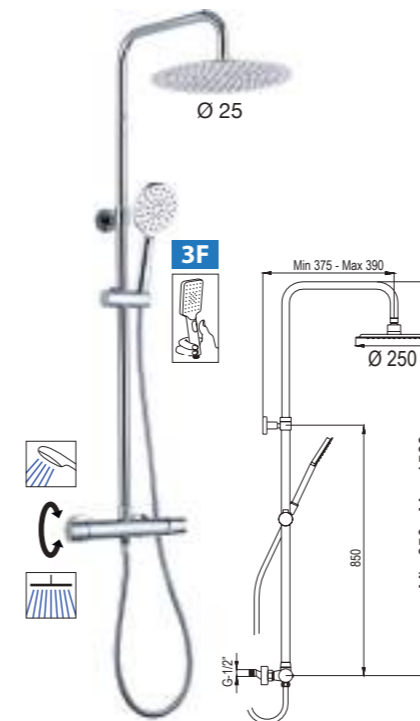

21NIR25TUA02

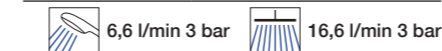

**Sistema de ducha monomando**  
Single lever mixer shower system  
Système de douche mitigeur  
Sistemi di doccia miscelatori

- Monomando con distribuidor incorporado
- Barra extensible de acero inoxidable AISI 304
- Flexo de acero inoxidable doble grapado, anti-torsión, 1,70 m

- Single lever mixer with integrated distributor
- Stainless steel AISI 304 extensible bar
- Stainless steel flexible shower hose double hooked, anti-twist, 1,70 m

- Mitigeur avec distributeur intégré
- Barre extensible en acier inoxydable AISI 304
- Flexible en acier inoxydable double agrafage, anti-torsion, 1,70 m

- Miscelatore con distributore integrato
- Barra allungabile in acciaio inossidabile AISI 304
- Flessibile di doppia aggraffatura in acciaio inossidabile, anti-torsione, 1,70 m

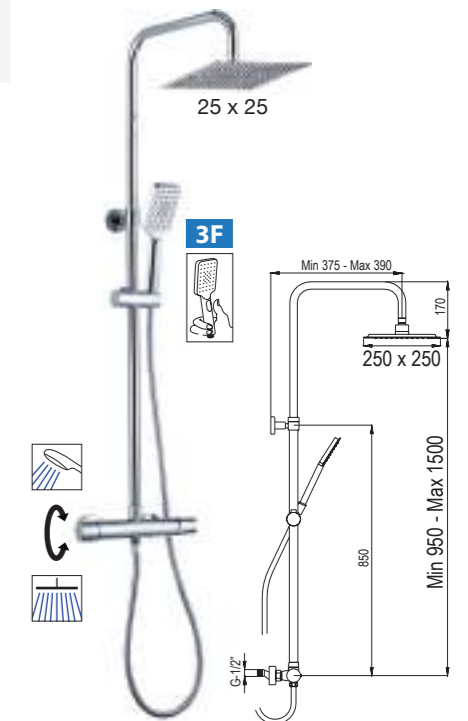

21NIC25TUA02





**Monomando de lavabo, negro**  
Single lever basin faucet, black  
Mitigeur de lavabo, noir  
Miscelatore per lavabo, nero

01TUB100NG 9 l/min 3 bar

01TUB108NG 5 l/min 3 bar

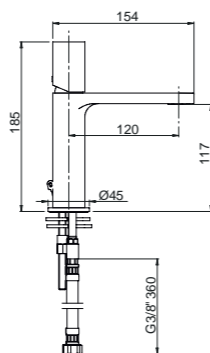

**Monomando alto de lavabo, negro**  
High single lever basin faucet, black  
Mitigeur de lavabo haut, noir  
Miscelatore per lavabo alto, nero

01TUB120NG 10,4 l/min 3 bar

01TUB128NG 5 l/min 3 bar

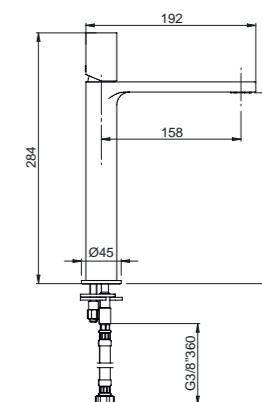



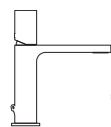

# TUBE

## GRIFERÍA DE BAÑO / BATHROOM FAUCETS ROBINETTERIE POUR SALLE DE BAIN / RUBINETTERIA DA BAGNO



**Monomando de bidet, negro**  
Single lever bidet faucet, black  
Mitigeur de bidet, noir  
Miscelatore per bidet, nero

01TUB200NG 8,3 l/min 3 bar

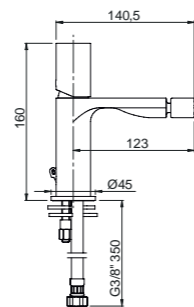

**Monomando de ducha, negro**  
Single lever shower faucet, black  
Mitigeur de douche, noir  
Miscelatore per doccia, nero

**Sin equipo / Without equipment**  
Sans équipement / Senza equipaggiamento

01TUB300NG

**Con equipo O / With equipment O**  
Avec équipement O / Con equipaggiamento O

01TUB317NG 7,1 l/min 3 bar

NEW

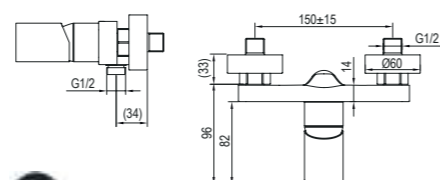

**Monomando de bañera, negro**  
Single lever bath faucet, black  
Mitigeur de baignoire, noir  
Miscelatore per vasca, nero

**Sin equipo / Without equipment**  
Sans équipement / Senza equipaggiamento

01TUB400NG 19,2 l/min 3 bar

**Con equipo O / With equipment O**  
Avec équipement O / Con equipaggiamento O

01TUB417NG 7,1 l/min 3 bar

NEW

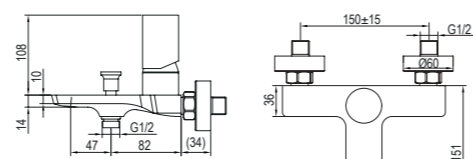

**Monomando de empotrar 2 vías, negro**  
2 ways concealed shower mixer, black  
Mitigeur à encastrer 2 voies, noir  
Miscelatore da incasso 2 vie, nero

01TUB351NG

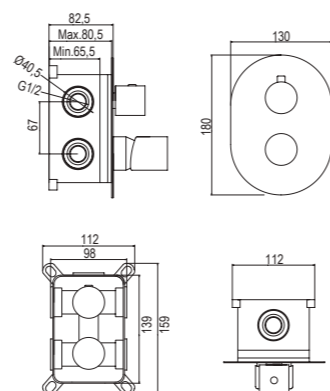

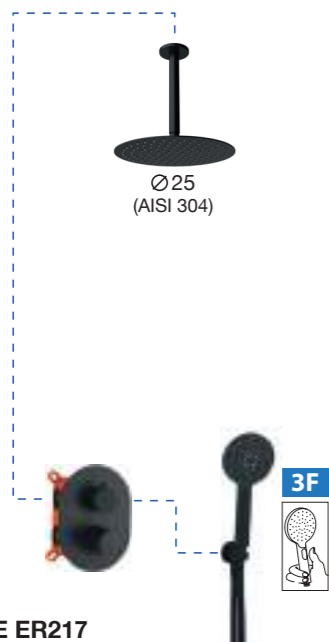

**KIT TUBE ER217**

Monomando de empotrar con rociador y set de ducha  
Concealed shower mixer with shower head and shower set  
Mitigeur à encastrer avec douche de tête et kit de douche  
Miscelatore da incasso con soffione attacco e kit doccia

19TUBER21705



**KIT TUBE ER208**

Monomando de empotrar con rociador y set de ducha  
Concealed shower mixer with shower head and shower set  
Mitigeur à encastrer avec douche de tête et kit de douche  
Miscelatore da incasso con soffione attacco e kit doccia

19TUBER20805



**OPCIONAL / OPTIONAL / OPTIONNEL / OPZIONALE**

Reductor caudal 9 l/min ducha/rociador  
Flow rate reducer 9 l/min hand shower/shower head  
Réducteur débit 9 l/min douchette/douche de tête  
Riduttore portata da 9 l/min maniglia doccia/soffione

6024

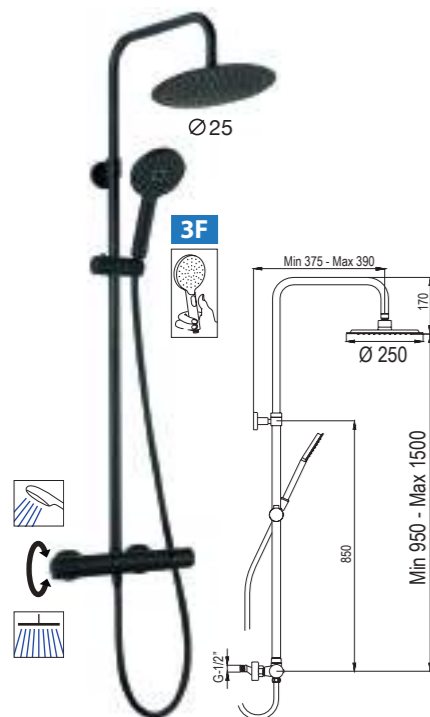
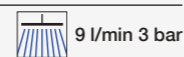

21NIR25TUA05



**Sistema de ducha monomando**  
Single lever mixer shower system  
Système de douche mitigeur  
Sistemi di doccia miscelatori

- Monomando con distribuidor incorporado
- Barra extensible de acero inoxidable AISI 304
- Flexo de PVC, antitorsión, 1,75 m

- Single lever mixer with integrated distributor
- Stainless steel AISI 304 extensible bar
- PVC flexible hose, anti-twist, 1,75 m

- Mitigeur avec distributeur intégré
- Barre extensible en acier inoxydable AISI 304
- Flexible en PVC, anti-torsion, 1,75 m

- Miscelatore con distributore integrato
- Barra allungabile in acciaio inossidabile AISI 304
- Flessibile in PVC, anti-torsione, 1,75 m



21NIC25TUA05





# TUBE

GRIFERÍA DE BAÑO / BATHROOM FAUCETS  
ROBINETTERIE POUR SALLE DE BAIN / RUBINETTERIA DA BAGNO

GRIFERÍA DE BAÑO  
BATHROOM FAUCETS



**Monomando de bidet, cromo/negro**  
Single lever bidet faucet, chrome/black  
Mitigeur de bidet, chromé/noir  
Miscelatore per bidet, cromato/nero

01TUB200NC 8,3 l/min 3 bar

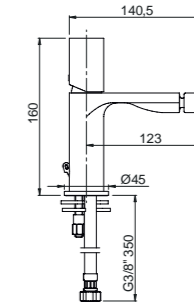

**Monomando de ducha, cromo/negro**  
Single lever shower faucet, chrome/black  
Mitigeur de douche, chromé/noir  
Miscelatore per doccia, cromato/nero

**Sin equipo / Without equipment**  
Sans équipement / Senza equipaggiamento  
01TUB300NC

**Con equipo Q / With equipment Q**  
Avec équipement Q / Con equipaggiamento Q  
01TUB321NC 7,1 l/min 3 bar

NEW

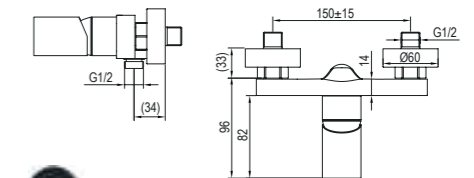

3F 170 cm.

**Monomando de bañera, cromo/negro**  
Single lever bath faucet, chrome/black  
Mitigeur de baignoire, chromé/noir  
Miscelatore per vasca, cromato/nero

**Sin equipo / Without equipment**  
Sans équipement / Senza equipaggiamento  
01TUB400NC 19,2 l/min 3 bar

**Con equipo Q / With equipment Q**  
Avec équipement Q / Con equipaggiamento Q  
01TUB421NC 7,1 l/min 3 bar

NEW

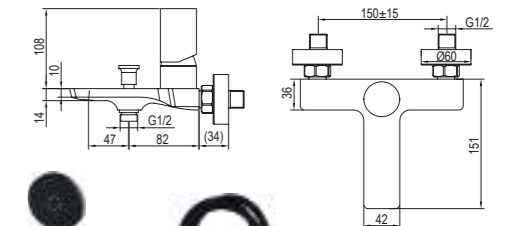

3F 170 cm.



**Monomando fregadera de caño flexible negro, cromo/negro**  
Single lever kitchen faucet, black flexible spout, chrome/black  
Mitigeur d'évier, bec haut flexible noir, chromé/noir  
Miscelatore per lavello, collo alto flessibile nero, cromato/nero

05BCT500NG 6,3 l/min 3 bar

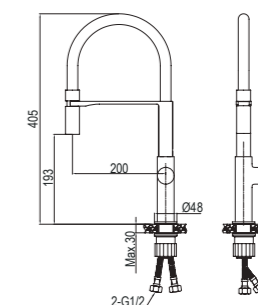

**Monomando de lavabo, cromo/negro**  
Single lever basin faucet, chrome/black  
Mitigeur de lavabo, chromé/noir  
Miscelatore per lavabo, cromato/nero

01TUB100NC 9 l/min 3 bar

01TUB108NC 5 l/min 3 bar

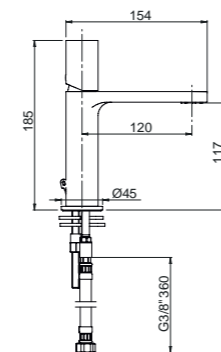

**Monomando alto de lavabo, cromo/negro**  
High single lever basin faucet, chrome/black  
Mitigeur de lavabo haut, chromé/noir  
Miscelatore per lavabo alto, cromato/nero

01TUB120NC 10,4 l/min 3 bar

01TUB128NC 5 l/min 3 bar

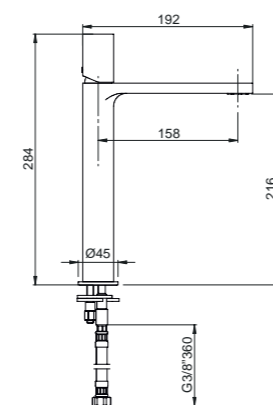

# ALPHA

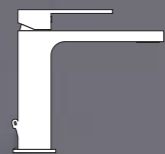

GRIFERÍA DE BAÑO  
BATHROOM FAUCETS  
ROBINETTERIE POUR SALLE DE BAIN  
RUBINETTERIA DA BAGNO



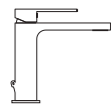

# ALPHA

GRIFERÍA DE BAÑO / BATHROOM FAUCETS  
ROBINETTERIE POUR SALLE DE BAIN / RUBINETTERIA DA BAGNO



**Monomando de lavabo, cromo**  
Single lever basin faucet, chrome  
Mitigeur de lavabo, chromé  
Miscelatore per lavabo, cromato

01ALP100CR 9 l/min 3 bar

01ALP108CR 5 l/min 3 bar

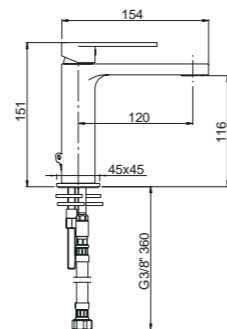

**Monomando alto de lavabo, cromo**  
High single lever basin faucet, chrome  
Mitigeur de lavabo haut, chromé  
Miscelatore per lavabo alto, cromato

01ALP120CR 10,4 l/min 3 bar

01ALP128CR 5 l/min 3 bar

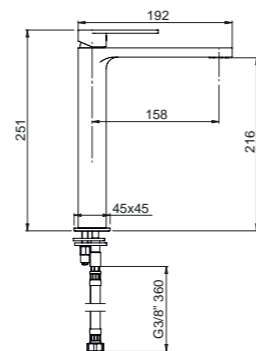

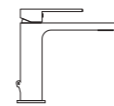

## ALPHA

GRIFERÍA DE BAÑO / BATHROOM FAUCETS  
ROBINETTERIE POUR SALLE DE BAIN / RUBINETTERIA DA BAGNO



**Monomando de bidet, cromo**  
Single lever bidet faucet, chrome  
Mitigeur de bidet, chromé  
Miscelatore per bidet, cromato

01ALP200CR 8,3 l/min 3 bar

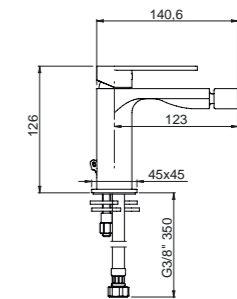

**Monomando de ducha, cromo**  
Single lever shower faucet, chrome  
Mitigeur de douche, chromé  
Miscelatore per doccia, cromato

**Sin equipo / Without equipment**  
Sans équipement / Senza equipaggiamento

01ALP300CR

**Con equipo J / With equipment J**  
Avec équipement J / Con equipaggiamento J

01ALP311CR 9 l/min 3 bar

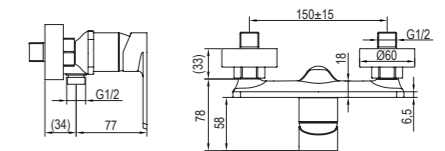

3F

170 cm.



**Monomando de bañera, cromo**  
Single lever bath faucet, chrome  
Mitigeur de baignoire, chromé  
Miscelatore per vasca, cromato

**Sin equipo / Without equipment**  
Sans équipement / Senza equipaggiamento

01ALP400CR 19,2 l/min 3 bar

**Con equipo J / With equipment J**  
Avec équipement J / Con equipaggiamento J

01ALP411CR 9 l/min 3 bar

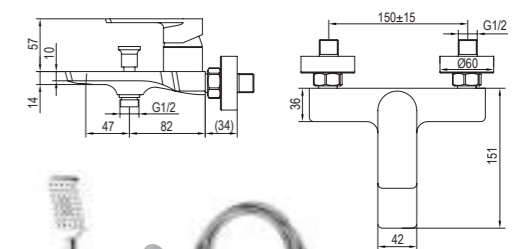

3F

170 cm.

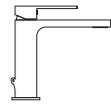

ALPHA

GRIFERÍA DE BAÑO / BATHROOM FAUCETS  
ROBINETTERIE POUR SALLE DE BAIN / RUBINETTERIA DA BAGNO



**Monomando fregadera de caño muelle, cromo**  
Single lever kitchen faucet, spring spout, chrome  
Mitigeur d'évier, bec haut à ressort, chromé  
Miscelatore per lavello, collo alto à molle, cromato

05COA500CR 8,3 l/min 3 bar

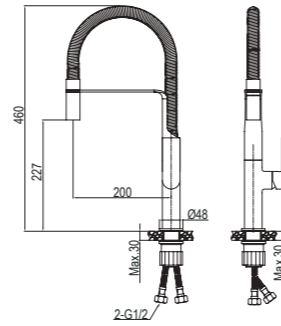

**Monomando fregadera de caño flexible negro, cromo**  
Single lever kitchen faucet, black flexible spout, chrome  
Mitigeur d'évier, bec haut flexible noir, chromé  
Miscelatore per lavello, collo alto flessibile nero, cromato

05BCA500NC 6,3 l/min 3 bar

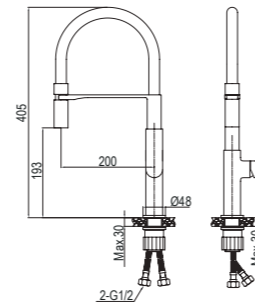

**Monomando fregadera**  
Single lever kitchen faucet  
Mitigeur d'évier  
Miscelatore per lavello

05MTA500CR 18,5 l/min 3 bar

05MTA509CR 5 l/min 3 bar

05MTA501CR 2P 6,3-15,8 l/min 3 bar

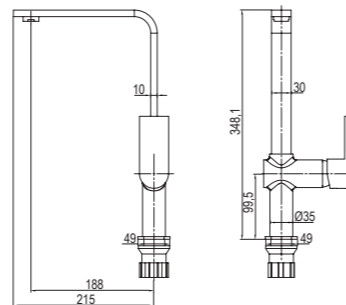

**Monomando de empotrar 1 vía, cromo**  
1 way concealed shower mixer, chrome  
Mitigeur à encastrer 1 voie, chromé  
Miscelatore da incasso 1 vía, cromato

01ALP350CR

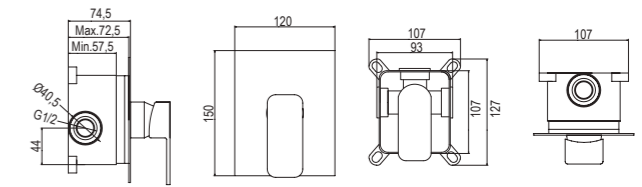

**Monomando de empotrar 2 vías, cromo**  
2 ways concealed shower mixer, chrome  
Mitigeur à encastrer 2 voies, chromé  
Miscelatore da incasso 2 vie, cromato

01ALP351CR

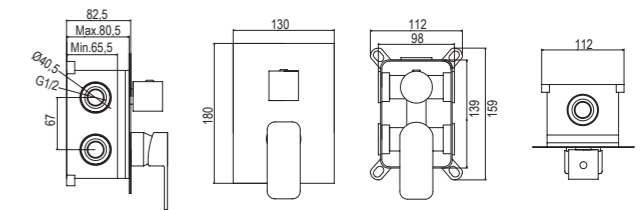

**Monomando de empotrar 3 vías, cromo**  
3 ways concealed shower mixer, chrome  
Mitigeur à encastrer 3 voies, chromé  
Miscelatore da incasso 3 vie, cromato

01ALP352CR

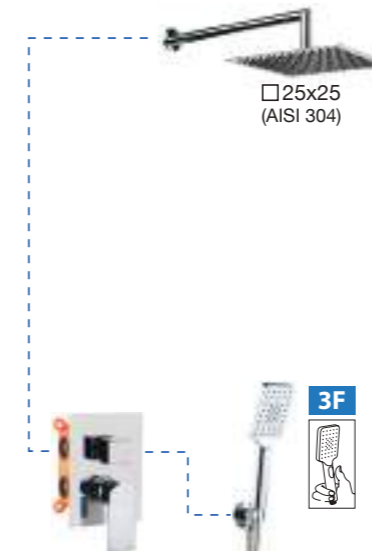
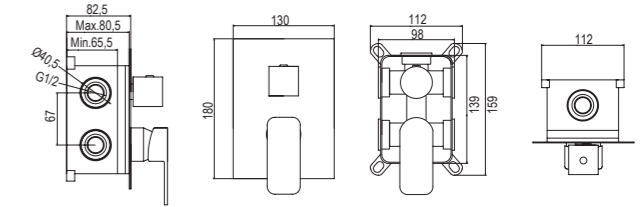

**KIT ALPHA EC216**

**Monomando de empotrar con rociador y set de ducha**  
Concealed shower mixer with shower head and shower set  
Mitigeur à encastrer avec douche de tête et kit de douche  
Miscelatore da incasso con soffione attacco e kit doccia

19ALPEC21602



7,1 l/min 3 bar



14,5 l/min 3 bar



OPCIONAL / OPTIONAL / OPTIONNEL / OPZIONALE

**Reductor caudal 9 l/min ducha/rociador**  
Flow rate reducer 9 l/min hand shower/shower head  
Réducteur débit 9 l/min douchette/douche de tête  
Riduttore portata da 9 l/min maniglia doccia/soffione

6024



9 l/min 3 bar

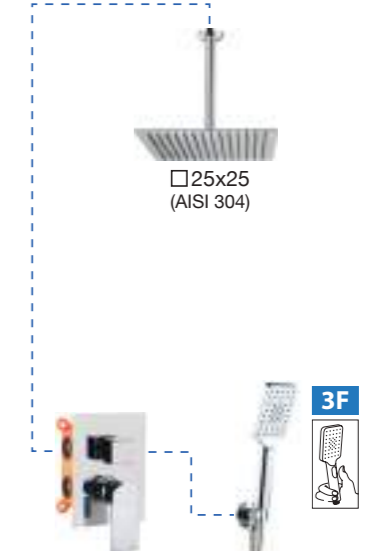

**KIT ALPHA EC218**

**Monomando de empotrar con rociador y set de ducha**  
Concealed shower mixer with shower head and shower set  
Mitigeur à encastrer avec douche de tête et kit de douche  
Miscelatore da incasso con soffione attacco e kit doccia

19ALPEC21802



7,1 l/min 3 bar



14,5 l/min 3 bar



OPCIONAL / OPTIONAL / OPTIONNEL / OPZIONALE

**Reductor caudal 9 l/min ducha/rociador**  
Flow rate reducer 9 l/min hand shower/shower head  
Réducteur débit 9 l/min douchette/douche de tête  
Riduttore portata da 9 l/min maniglia doccia/soffione

6024



9 l/min 3 bar

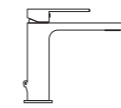

## ALPHA

GRIFERÍA DE BAÑO / BATHROOM FAUCETS  
ROBINETTERIE POUR SALLE DE BAIN / RUBINETTERIA DA BAGNO



### Sistema de ducha monomando / Single lever mixer shower system Système de douche mitigeur / Sistemi di doccia miscelatori

- Monomando con distribuidor incorporado
- Rociador de Ø 25 cm, de acero inoxidable AISI 304
- Barra extensible de acero inoxidable AISI 304
- Flexo de acero inoxidable doble grapado, antitorsi3n, 1,70 m

- Single lever mixer with integrated distributor
- Stainless steel AISI 304 shower head, Ø 25 cm
- Stainless steel AISI 304 extensible bar
- Stainless steel flexible shower hose double hooked, anti-twist, 1,70 m

- Mitigeur avec distributeur int3gr3
- Douche de t3te de Ø 25 cm, en acier inoxydable AISI 304
- Barre extensible en acier inoxydable AISI 304
- Flexible en acier inoxydable double agrafage, anti-torsion, 1,70 m

- Miscelatore con distributore integrato
- Soffione Ø 25 cm, in acciaio inossidabile AISI 304
- Barra allungabile in acciaio inossidabile AISI 304
- Flessibile di doppia aggraffatura in acciaio inossidabile, anti-torsione, 1,70 m

21NIR25ALA02



6,6 l/min 3 bar



16,6 l/min 3 bar

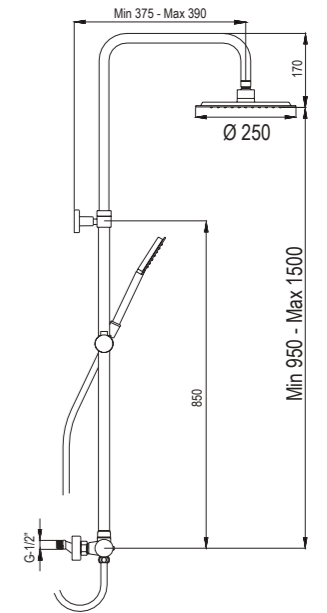

### OPCIONAL / OPTIONAL / OPTIONNEL / OPZIONALE

**Reductor caudal 9 l/min ducha/rociador**  
Flow rate reducer 9 l/min hand shower/shower head  
Réducteur débit 9 l/min douchette/douche de t3te  
Riduttore portata da 9 l/min maniglia doccia/soffione

6024



9 l/min 3 bar



### Sistema de ducha monomando / Single lever mixer shower system Système de douche mitigeur / Sistemi di doccia miscelatori

- Monomando con distribuidor incorporado
- Rociador de 25 x 25 cm, de acero inoxidable AISI 304
- Barra extensible de acero inoxidable AISI 304
- Flexo de acero inoxidable doble grapado, antitorsi3n, 1,70 m

- Single lever mixer with integrated distributor
- Stainless steel AISI 304 shower head, 25 x 25 cm
- Stainless steel AISI 304 extensible bar
- Stainless steel flexible shower hose double hooked, anti-twist, 1,70 m

- Mitigeur avec distributeur int3gr3
- Douche de t3te de 25 x 25 cm, en acier inoxydable AISI 304
- Barre extensible en acier inoxydable AISI 304
- Flexible en acier inoxydable double agrafage, anti-torsion, 1,70 m

- Miscelatore con distributore integrato
- Soffione 25 x 25 cm, in acciaio inossidabile AISI 304
- Barra allungabile in acciaio inossidabile AISI 304
- Flessibile di doppia aggraffatura in acciaio inossidabile, anti-torsione, 1,70 m

21NIC25ALA02



9,6 l/min 3 bar



18,3 l/min 3 bar

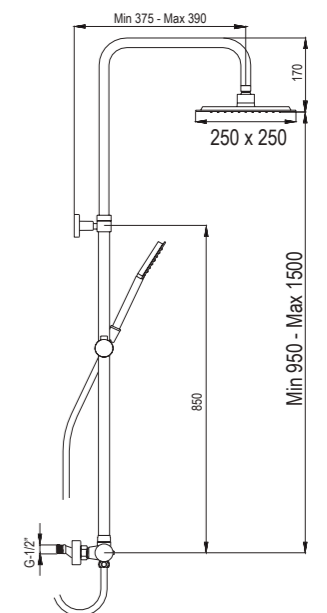





**Monomando de ducha, negro**  
 Single lever shower faucet, black  
 Mitigeur de douche, noir  
 Miscelatore per doccia, nero

**Sin equipo / Without equipment**  
 Sans équipement / Senza equipaggiamento

01ALP300NG

**Con equipo N / With equipment N**  
 Avec équipement N / Con equipaggiamento N

01ALP316NG 9 l/min 3 bar

**NEW**

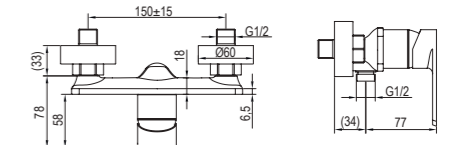

**3F**

170 cm.



**Monomando de lavabo, negro**  
 Single lever basin faucet, black  
 Mitigeur de lavabo, noir  
 Miscelatore per lavabo, nero

01ALP100NG 9 l/min 3 bar

01ALP108NG 5 l/min 3 bar

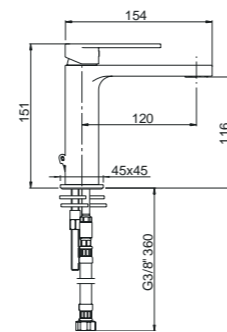

**Monomando alto de lavabo, negro**  
 High single lever basin faucet, black  
 Mitigeur de lavabo haut, noir  
 Miscelatore per lavabo alto, nero

01ALP120NG 10,4 l/min 3 bar

01ALP128NG 5 l/min 3 bar

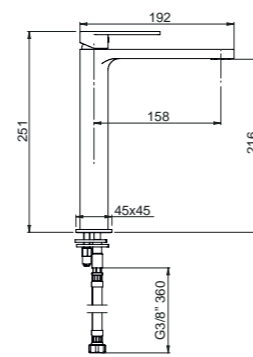

**Monomando de bidet, negro**  
 Single lever bidet faucet, black  
 Mitigeur de bidet, noir  
 Miscelatore per bidet, nero

01ALP200NG 8,3 l/min 3 bar

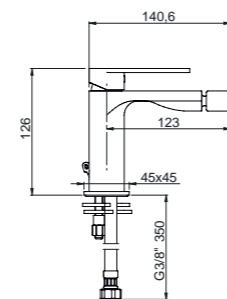



**Monomando de bañera, negro**  
Single lever bath faucet, black  
Mitigeur de baignoire, noir  
Miscelatore per vasca, nero

**Sin equipo / Without equipment**  
Sans équipement / Senza equipaggiamento

01ALP400NG 19,2 l/min 3 bar

**Con equipo N / With equipment N**  
Avec équipement N / Con equipaggiamento N

01ALP416NG 9 l/min 3 bar

**NEW**

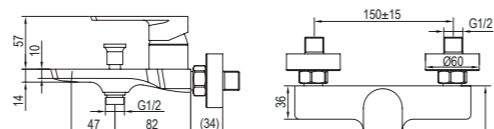

3F 170 cm.



**Monomando de empotrar 2 vías, negro**  
2 ways concealed shower mixer, black  
Mitigeur à encastrer 2 voies, noir  
Miscelatore da incasso 2 vie, nero

01ALP351NG

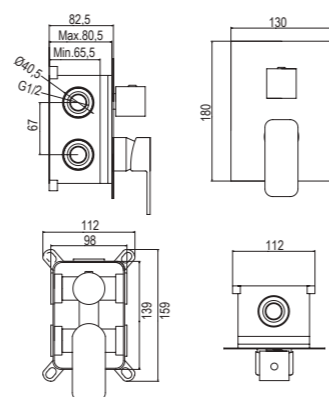

**KIT ALPHA EC208**

**Monomando de empotrar con rociador y set de ducha**  
Concealed shower mixer with shower head and shower set  
Mitigeur à encastrer avec douche de tête et kit de douche  
Miscelatore da incasso con soffione attacco e kit doccia

19ALPEC20805



**OPCIONAL / OPTIONAL / OPTIONNEL / OPZIONALE**

**Reductor caudal 9 l/min ducha/rociador**  
Flow rate reducer 9 l/min hand shower/shower head  
Réducteur débit 9 l/min douchette/douche de tête  
Riduttore portata da 9 l/min maniglia doccia/soffione

6024

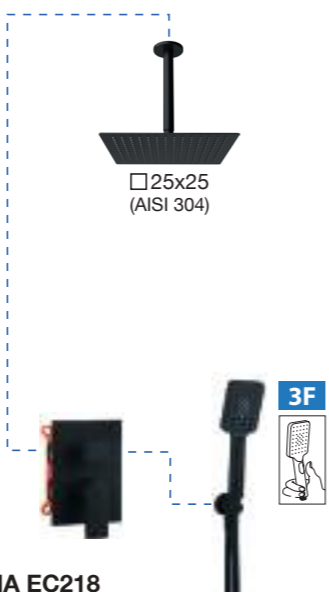

**KIT ALPHA EC218**

**Monomando de empotrar con rociador y set de ducha**  
Concealed shower mixer with shower head and shower set  
Mitigeur à encastrer avec douche de tête et kit de douche  
Miscelatore da incasso con soffione attacco e kit doccia

19ALPEC21805



**OPCIONAL / OPTIONAL / OPTIONNEL / OPZIONALE**

**Reductor caudal 9 l/min ducha/rociador**  
Flow rate reducer 9 l/min hand shower/shower head  
Réducteur débit 9 l/min douchette/douche de tête  
Riduttore portata da 9 l/min maniglia doccia/soffione

6024

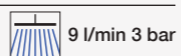



- Monomando con distribuidor incorporado
- Rociador de 25 x 25 cm, de acero inoxidable AISI 304
- Barra extensible de acero inoxidable AISI 304
- Flexo de PVC, antitorsión, 1,75 m

- Single lever mixer with integrated distributor
- Stainless steel AISI 304 shower head, 25 x 25 cm
- Stainless steel AISI 304 extensible bar
- PVC flexible hose, anti-twist, 1,75 m

- Mitigeur avec distributeur intégré
- Douche de tête de 25 x 25 cm, en acier inoxydable AISI 304
- Barre extensible en acier inoxydable AISI 304
- Flexible en PVC, anti-torsion, 1,75 m

- Miscelatore con distributore integrato
- Soffione 25 x 25 cm, in acciaio inossidabile AISI 304
- Barra allungabile in acciaio inossidabile AISI 304
- Flessibile in PVC, anti-torsione, 1,75 m

21NITC25ALA05

 9,6 l/min 3 bar  18,3 l/min 3 bar

OPCIONAL / OPTIONAL / OPTIONNEL / OPZIONALE

**Reductor caudal 9 l/min ducha/rociador**  
Flow rate reducer 9 l/min hand shower/shower head  
Réducteur débit 9 l/min douchette/douche de tête  
Riduttore portata da 9 l/min maniglia doccia/soffione

6024 

 9 l/min 3 bar



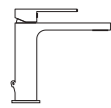

**Monomando de lavabo, blanco**  
Single lever basin faucet, white  
Mitigeur de lavabo, blanc  
Miscelatore per lavabo, bianco

01ALP100BL 9 l/min 3 bar

01ALP108BL 5 l/min 3 bar

NEW

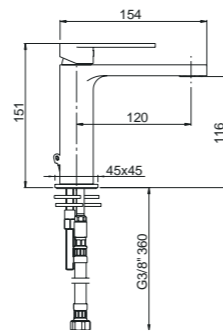

**Monomando alto de lavabo, blanco**  
High single lever basin faucet, white  
Mitigeur de lavabo haut, blanc  
Miscelatore per lavabo alto, bianco

01ALP120BL 10,4 l/min 3 bar

01ALP128BL 5 l/min 3 bar

NEW

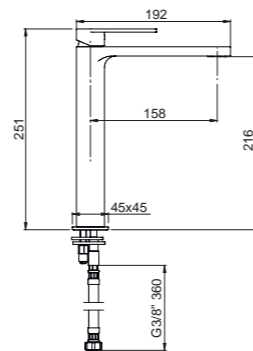

**Monomando de bidet, blanco**  
Single lever bidet faucet, white  
Mitigeur de bidet, blanc  
Miscelatore per bidet, bianco

01ALP200BL 8,3 l/min 3 bar

NEW

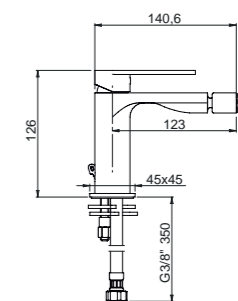

**Monomando de empotrar 2 vías, blanco**  
2 ways concealed shower mixer, white  
Mitigeur à encastrer 2 voies, blanc  
Miscelatore da incasso 2 vie, bianco

01ALP351BL

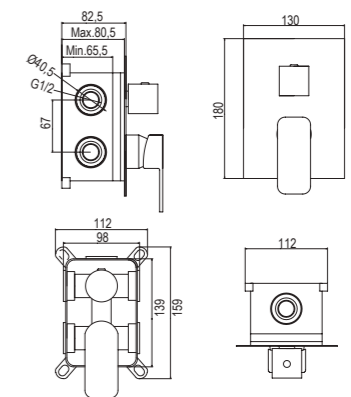

NEW



**KIT ALPHA EC218**

**Monomando de empotrar con rociador y set de ducha**  
 Concealed shower mixer with shower head and shower set  
 Mitigeur à encastrer avec douche de tête et kit de douche  
 Miscelatore da incasso con soffione attacco e kit doccia

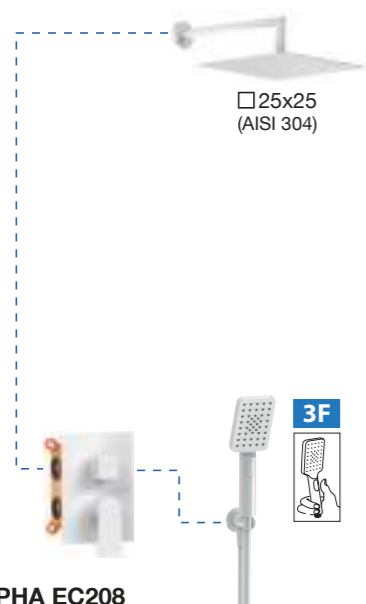

19ALPEC21803

**NEW**  7,1 l/min 3 bar  14,5 l/min 3 bar 

**KIT ALPHA EC208**

**Monomando de empotrar con rociador y set de ducha**  
 Concealed shower mixer with shower head and shower set  
 Mitigeur à encastrer avec douche de tête et kit de douche  
 Miscelatore da incasso con soffione attacco e kit doccia

19ALPEC20803

**NEW**  7,1 l/min 3 bar  14,5 l/min 3 bar 

**OPCIONAL / OPTIONAL / OPTIONNEL / OPZIONALE**

**Reductor caudal 9 l/min ducha/rociador**  
 Flow rate reducer 9 l/min hand shower/shower head  
 Réducteur débit 9 l/min douchette/douche de tête  
 Riduttore portata da 9 l/min maniglia doccia/soffione

6024 

 9 l/min 3 bar





- Monomando con distribuidor incorporado
- Rociador de 25 x 25 cm, de acero inoxidable AISI 304
- Barra extensible de acero inoxidable AISI 304
- Flexo de PVC, antitorsión, 1,75 m

- Single lever mixer with integrated distributor
- Stainless steel AISI 304 shower head, 25 x 25 cm
- Stainless steel AISI 304 extensible bar
- PVC flexible hose, anti-twist, 1,75 m

- Mitigeur avec distributeur intégré
- Douche de tête de 25 x 25 cm, en acier inoxydable AISI 304
- Barre extensible en acier inoxydable AISI 304
- Flexible en PVC, anti-torsion, 1,75 m



- Miscelatore con distributore integrato
- Soffione 25 x 25 cm, in acciaio inossidabile AISI 304
- Barra allungabile in acciaio inossidabile AISI 304
- Flessibile in PVC, anti-torsione, 1,75 m

21NIC25ALA03

**NEW**  9,6 l/min 3 bar  18,3 l/min 3 bar

OPCIONAL / OPTIONAL / OPTIONNEL / OPZIONALE

**Reductor caudal 9 l/min ducha/rociador**  
 Flow rate reducer 9 l/min hand shower/shower head  
 Réducteur débit 9 l/min douchette/douche de tête  
 Riduttore portata da 9 l/min maniglia doccia/soffione

6024   9 l/min 3 bar





# BOLD

GRIFERÍA DE BAÑO  
BATHROOM FAUCETS  
ROBINETTERIE POUR SALLE DE BAIN  
RUBINETTERIA DA BAGNO



**Monomando de lavabo, cromo**  
Single lever basin faucet, chrome  
Mitigeur de lavabo, chromé  
Miscelatore per lavabo, cromato

01BOL100CR 14,2 l/min 3 bar  
01BOL108CR 5 l/min 3 bar

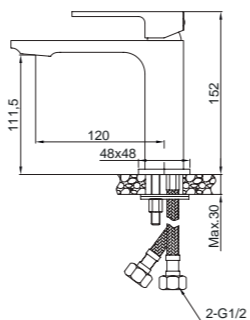

**Monomando alto de lavabo, cromo**  
High single lever basin faucet, chrome  
Mitigeur de lavabo haut, chromé  
Miscelatore per lavabo alto, cromato

01BOL120CR 15,4 l/min 3 bar  
01BOL128CR 5 l/min 3 bar

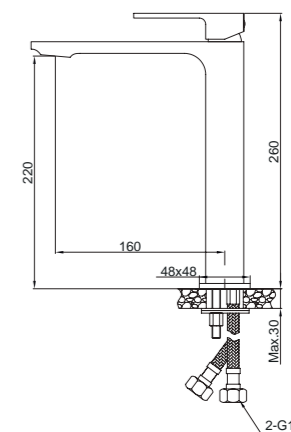



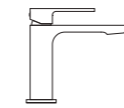

# BOLD

GRIFERÍA DE BAÑO / BATHROOM FAUCETS  
ROBINETTERIE POUR SALLE DE BAIN / RUBINETTERIA DA BAGNO



**Monomando de ducha, cromo**  
Single lever shower faucet, chrome  
Mitigeur de douche, chromé  
Miscelatore per doccia, cromato

**Sin equipo / Without equipment**  
Sans équipement / Senza equipaggiamento

01BOL300CR

**Con equipo J / With equipment J**  
Avec équipement J / Con equipaggiamento J

01BOL311CR 9 l/min 3 bar

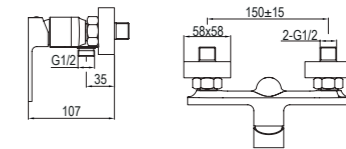

3F

170 cm.



**Monomando de bañera, cromo**  
Single lever bath faucet, chrome  
Mitigeur de baignoire, chromé  
Miscelatore per vasca, cromato

**Sin equipo / Without equipment**  
Sans équipement / Senza equipaggiamento

01BOL400CR 18,3 l/min 3 bar

**Con equipo J / With equipment J**  
Avec équipement J / Con equipaggiamento J

01BOL411CR 7,5 l/min 3 bar

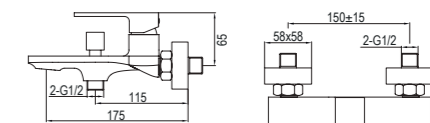

3F

170 cm.



**Monomando de empotrar 1 vía, cromo**  
1 way concealed shower mixer, chrome  
Mitigeur à encastrer 1 voie, chromé  
Miscelatore da incasso 1 via, cromato

01BOL350CR

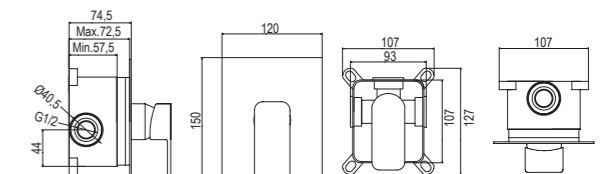

**Monomando de empotrar 2 vías, cromo**  
2 ways concealed shower mixer, chrome  
Mitigeur à encastrer 2 voies, chromé  
Miscelatore da incasso 2 vie, cromato

01BOL351CR

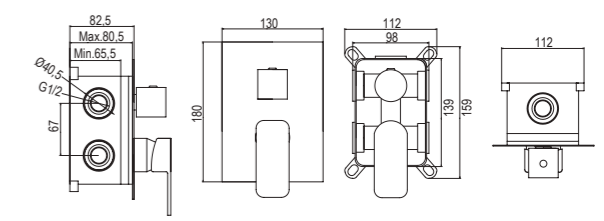

**Monomando de empotrar 3 vías, cromo**  
3 ways concealed shower mixer, chrome  
Mitigeur à encastrer 3 voies, chromé  
Miscelatore da incasso 3 vie, cromato

01BOL352CR

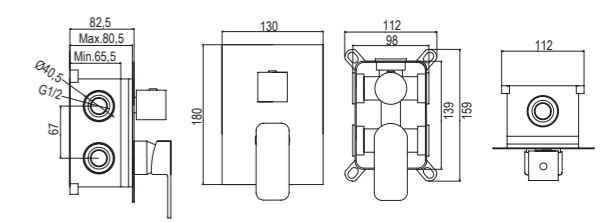

**Monomando de bidet, cromo**  
Single lever bidet faucet, chrome  
Mitigeur de bidet, chromé  
Miscelatore per bidet, cromato

01BOL200CR 10,8 l/min 3 bar

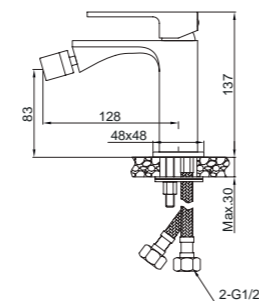

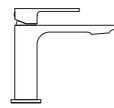
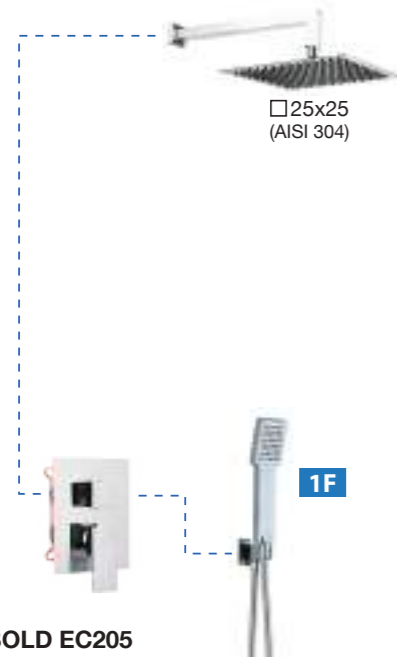
**BOLD**GRIFERÍA DE BAÑO / BATHROOM FAUCETS  
ROBINETTERIE POUR SALLE DE BAIN / RUBINETTERIA DA BAGNO□ 25x25  
(AISI 304)

1F

**KIT BOLD EC205****Monomando de empotrar con rociador y set de ducha**  
Concealed shower mixer with shower head and shower set  
Mitigeur à encastrer avec douche de tête et kit de douche  
Miscelatore da incasso con soffione attacco e kit doccia

19BOLEC20502

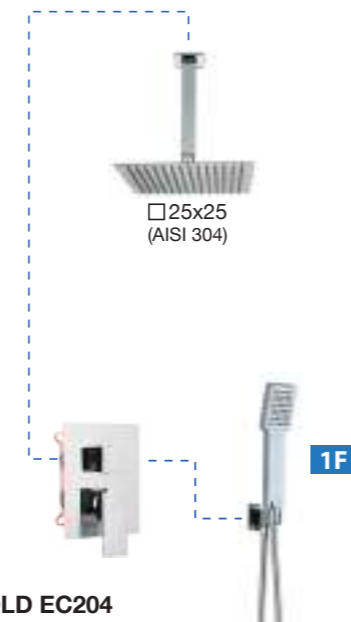
□ 25x25  
(AISI 304)

1F

**KIT BOLD EC204****Monomando de empotrar con rociador y set de ducha**  
Concealed shower mixer with shower head and shower set  
Mitigeur à encastrer avec douche de tête et kit de douche  
Miscelatore da incasso con soffione attacco e kit doccia

19BOLEC20402

**OPCIONAL / OPTIONAL / OPTIONNEL / OPZIONALE****Kit 2 reductores caudal 9 l/min ducha/rociador**  
2 flow rate reducer kit 9 l/min hand shower/head shower  
Kit 2 réducteurs débit 9l/min douchette/douche de tête  
Kit 2 riduttori portata 9 l/min maniglia doccia/soffione

6024X2

**OPCIONES DE ROCIADOR**  
SHOWER HEAD OPTIONS  
OPTIONS POUR DOUCHE DE TÊTE  
OPZIONI PER SOFFIONE**Atlas C20**en AISI 304  
in AISI304  
en AISI 304  
in AISI 304

20 x 20 cm

21LUC20LUD02

**Atlas C25**en AISI 304  
in AISI304  
en AISI 304  
in AISI 304

25 x 25 cm

21LUC25LUD02

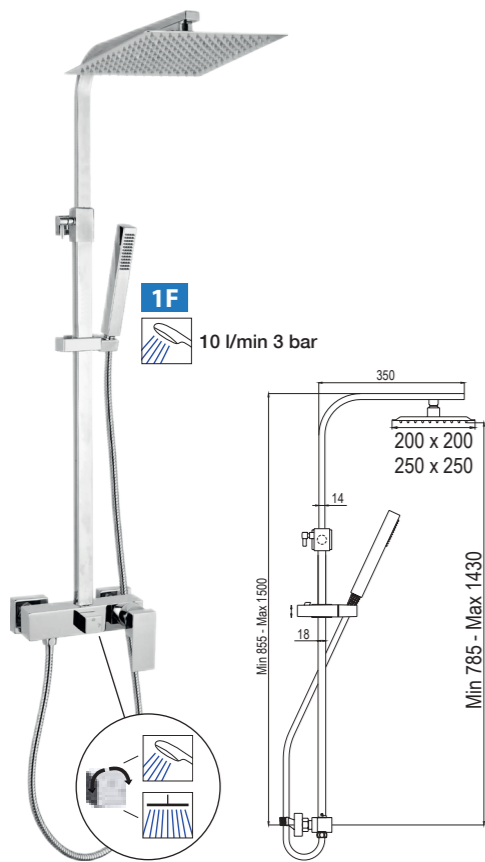
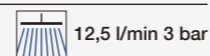

1F

10 l/min 3 bar

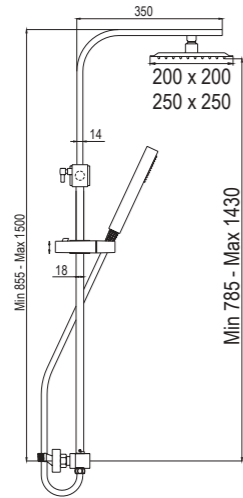
**Sistema de ducha monomando**Single lever mixer shower system  
Système de douche mitigeur  
Sistemi di doccia miscelatori

- Monomando con distribuidor incorporado
- Barra extensible de acero inoxidable
- Flexo de acero inoxidable doble grapado, antitorsión, 1,70 m
- Single lever mixer with integrated distributor
- Stainless steel extensible bar
- Stainless steel flexible shower hose double hooked, anti-twist, 1,70 m
- Mitigeur avec distributeur intégré
- Barre extensible en acier inoxydable
- Flexible en acier inoxydable double agrafage, anti-torsion, 1,70 m
- Miscelatore con distributore integrato
- Barra allungabile in acciaio inossidabile
- Flessibile di doppia aggraffatura in acciaio inossidabile, anti-torsione, 1,70 m





**Monomando de lavabo, negro**  
Single lever basin faucet, black  
Mitigeur de lavabo, noir  
Miscelatore per lavabo, nero

01BOL100NG 15,4 l/min 3 bar

01BOL108NG 5 l/min 3 bar

NEW

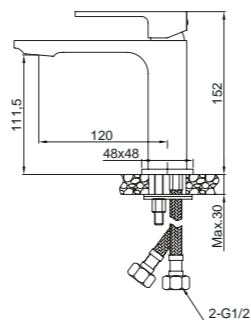

**Monomando alto de lavabo, negro**  
High single lever basin faucet, black  
Mitigeur de lavabo haut, noir  
Miscelatore per lavabo alto, nero

01BOL120NG 14,2 l/min 3 bar

01BOL128NG 5 l/min 3 bar

NEW

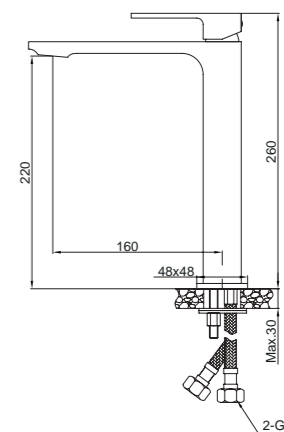

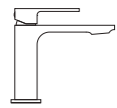

**BOLD**

GRIFERÍA DE BAÑO / BATHROOM FAUCETS  
ROBINETTERIE POUR SALLE DE BAIN / RUBINETTERIA DA BAGNO



**Monomando de bidet, negro**  
Single lever bidet faucet, black  
Mitigeur de bidet, noir  
Miscelatore per bidet, nero

01BOL200NG 8,3 l/min 3 bar

NEW

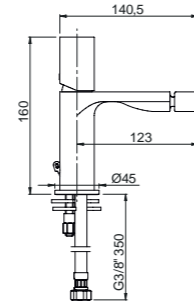

**Monomando de ducha, negro**  
Single lever shower faucet, black  
Mitigeur de douche, noir  
Miscelatore per doccia, nero

**Sin equipo / Without equipment**  
Sans équipement / Senza equipaggiamento

01BOL300NG

**Con equipo N / With equipment N**  
Avec équipement N / Con equipaggiamento N

01BOL316NG 9 l/min 3 bar

NEW

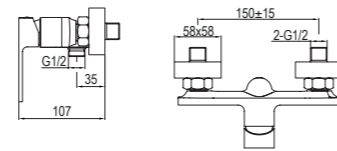

3F 170 cm.

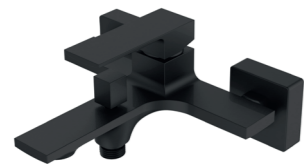

**Monomando de bañera, negro**  
Single lever bath faucet, black  
Mitigeur de baignoire, noir  
Miscelatore per vasca, nero

**Sin equipo / Without equipment**  
Sans équipement / Senza equipaggiamento

01BOL400NG 18,3 l/min 3 bar

**Con equipo N / With equipment N**  
Avec équipement N / Con equipaggiamento N

01BOL416NG 7,5 l/min 3 bar

NEW

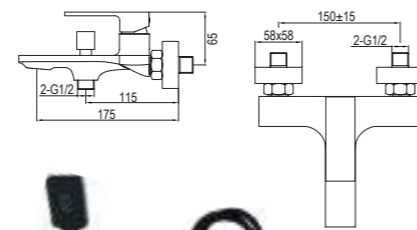

3F 170 cm.



**Monomando de empotrar 2 vías, negro**  
2 ways concealed shower mixer, black  
Mitigeur à encastrer 2 voies, noir  
Miscelatore da incasso 2 vie, nero

01BOL351NG

NEW

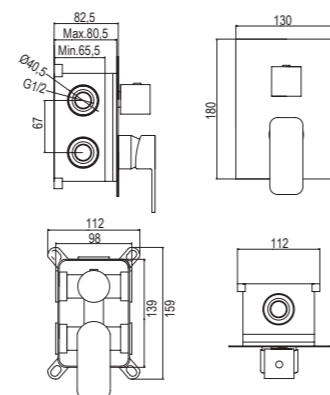

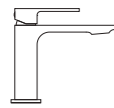
**BOLD**GRIFERÍA DE BAÑO / BATHROOM FAUCETS  
ROBINETTERIE POUR SALLE DE BAIN / RUBINETTERIA DA BAGNO**KIT BOLD EC217**

**Monomando de empotrar con rociador y set de ducha**  
 Concealed shower mixer with shower head and shower set  
 Mitigeur à encastrer avec douche de tête et kit de douche  
 Miscelatore da incasso con soffione attacco e kit doccia

19BOLEC21705

**NEW** 7,1 l/min 3 bar 14,5 l/min 3 bar

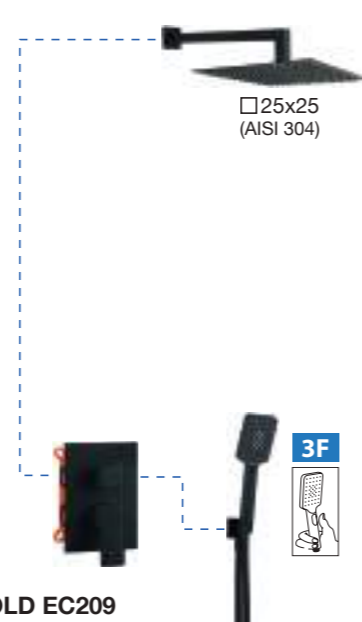
**KIT BOLD EC209**

**Monomando de empotrar con rociador y set de ducha**  
 Concealed shower mixer with shower head and shower set  
 Mitigeur à encastrer avec douche de tête et kit de douche  
 Miscelatore da incasso con soffione attacco e kit doccia

19BOLEC20905

**NEW** 7,1 l/min 3 bar 14,5 l/min 3 bar

## OPCIONAL / OPTIONAL / OPTIONNEL / OPZIONALE

**Reductor caudal 9 l/min ducha/rociador**  
 Flow rate reducer 9 l/min hand shower/shower head  
 Réducteur débit 9 l/min douchette/douche de tête  
 Riduttore portata da 9 l/min maniglia doccia/soffione

6024

9 l/min 3 bar

**Sistema de ducha monomando / Single lever mixer shower system**  
Système de douche mitigeur / Sistemi di doccia miscelatori

- Monomando con distribuidor incorporado
- Rociador de 25 x 25 cm, de acero inoxidable AISI 304
- Barra extensible de acero inoxidable
- Flexo de PVC, antitorsión, 1,75 m
- Single lever mixer with integrated distributor
- Stainless steel AISI 304 shower head, 25 x 25 cm
- Stainless steel extensible bar
- PVC flexible hose, anti-twist, 1,75 m
- Mitigeur avec distributeur intégré
- Douche de tête de 25 x 25 cm, en acier inoxydable AISI 304
- Barre extensible en acier inoxydable
- Flexible en PVC, anti-torsion, 1,75 m
- Miscelatore con distributore integrato
- Soffione 25 x 25 cm, in acciaio inossidabile AISI 304
- Barra allungabile in acciaio inossidabile
- Flessibile in PVC, anti-torsione, 1,75 m

21QUC25LUD05

**NEW** 10 l/min 3 bar 12,5 l/min 3 bar

Disponibile: Marzo 2022 / Available: March 2022  
 Disponibile: Mars 2022 / Disponibile: Marzo 2022

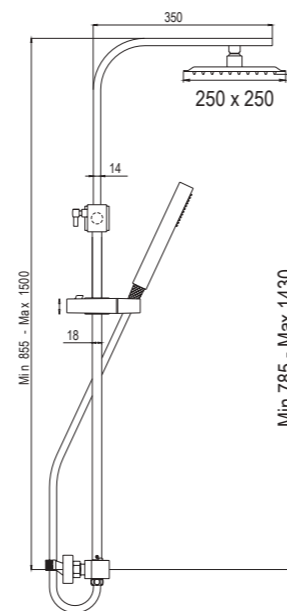

# BETA

GRIFERÍA DE BAÑO  
BATHROOM FAUCETS  
ROBINETTERIE POUR SALLE DE BAIN  
RUBINETTERIA DA BAGNO



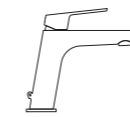

**BETA**

**GRIFERÍA DE BAÑO / BATHROOM FAUCETS**  
ROBINETTERIE POUR SALLE DE BAIN / RUBINETTERIA DA BAGNO

GRIFERÍA DE BAÑO  
BATHROOM FAUCETS



**Monomando de bidet, cromo**  
Single lever bidet faucet, chrome  
Mitigeur de bidet, chromé  
Miscelatore per bidet, cromato

01BET200CR 8,3 l/min 3 bar

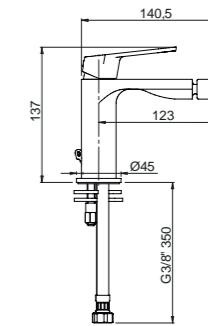

**Monomando de ducha, cromo**  
Single lever shower faucet, chrome  
Mitigeur de douche, chromé  
Miscelatore per doccia, cromato

**Sin equipo / Without equipment**  
Sans équipement / Senza equipaggiamento

01BE2300CR

**Con equipo I / With equipment I**  
Avec équipement I / Con equipaggiamento I

01BE2310CR 7,5 l/min 3 bar

NEW

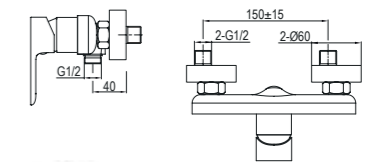

**Monomando de bañera, cromo**  
Single lever bath faucet, chrome  
Mitigeur de baignoire, chromé  
Miscelatore per vasca, cromato

**Sin equipo / Without equipment**  
Sans équipement / Senza equipaggiamento

01BE2400CR 21,7 l/min 3 bar

**Con equipo I / With equipment I**  
Avec équipement I / Con equipaggiamento I

01BE2410CR 7,5 l/min 3 bar

NEW

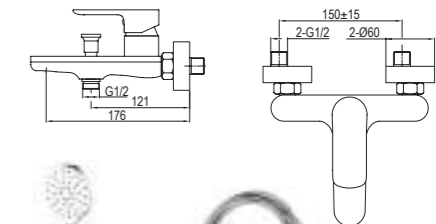

**Monomando fregadera**  
Single lever kitchen faucet  
Mitigeur d'évier  
Miscelatore per lavello

05MIB500CR 19,8 l/min 3 bar

05MIB509CR 5 l/min 3 bar

05MIB501CR 2P 6,5-13,2 l/min 3 bar

NEW

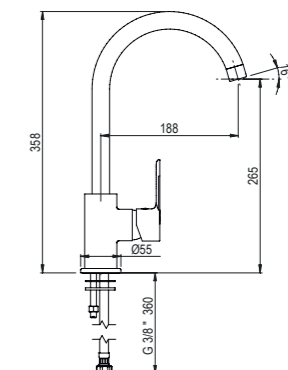

**Monomando de lavabo, cromo**  
Single lever basin faucet, chrome  
Mitigeur de lavabo, chromé  
Miscelatore per lavabo, cromato

01BET100CR 6,7 l/min 3 bar

01BET108CR 5 l/min 3 bar

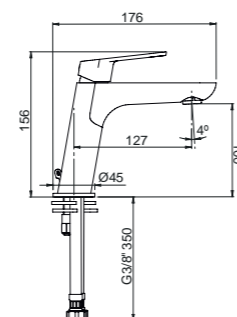



**Monomando de empotrar 1 vía, cromo**  
1 way concealed shower mixer, chrome  
Mitigeur à encastrer 1 voie, chromé  
Miscelatore da incasso 1 via, cromato

01BET350CR

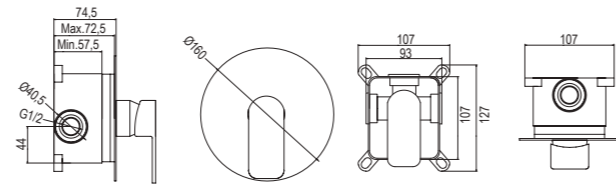

**Monomando de empotrar 2 vías, cromo**  
2 ways concealed shower mixer, chrome  
Mitigeur à encastrer 2 voies, chromé  
Miscelatore da incasso 2 vie, cromato

01BET351CR

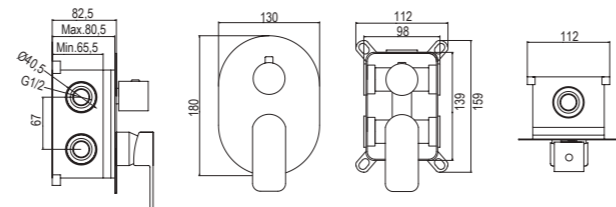

**Monomando de empotrar 3 vías, cromo**  
3 ways concealed shower mixer, chrome  
Mitigeur à encastrer 3 voies, chromé  
Miscelatore da incasso 3 vie, cromato

01BET352CR

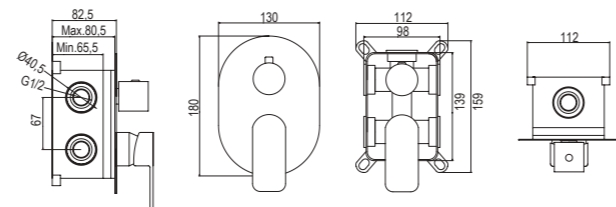

**OPCIONAL / OPTIONAL / OPTIONNEL / OPZIONALE**

**Reductor caudal 9 l/min ducha/rociador**  
Flow rate reducer 9 l/min hand shower/shower head  
Réducteur débit 9 l/min douchette/douche de tête  
Riduttore portata da 9 l/min maniglia doccia/soffione

6024

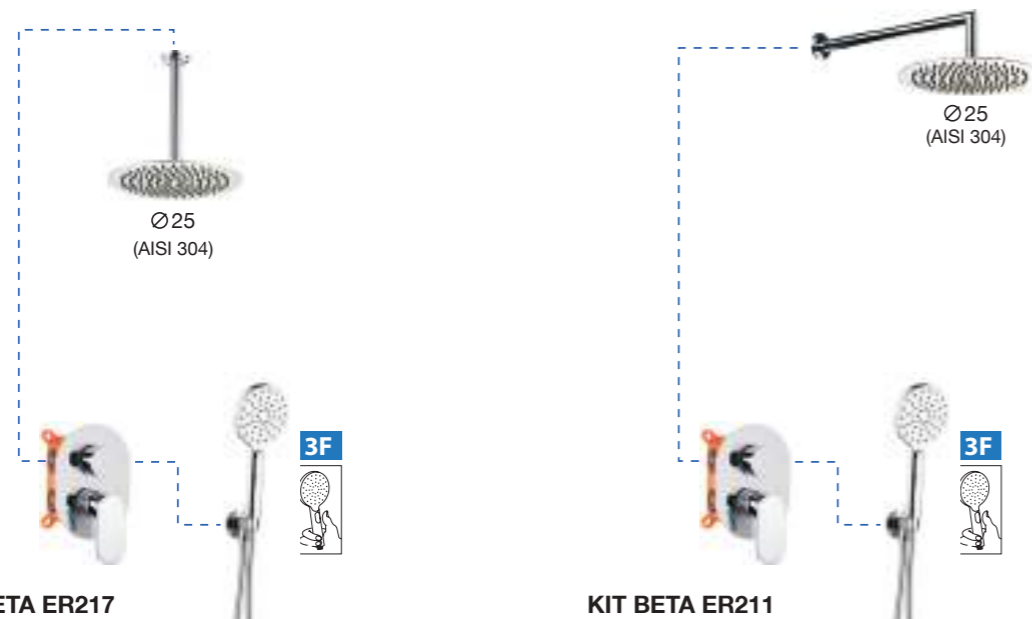
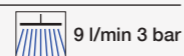

**KIT BETA ER217**

**Monomando de empotrar con rociador y set de ducha**  
Concealed shower mixer with shower head and shower set  
Mitigeur à encastrer avec douche de tête et kit de douche  
Miscelatore da incasso con soffione attacco e kit doccia

19BETER21702

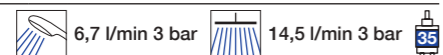

**KIT BETA ER211**

**Monomando de empotrar con rociador y set de ducha**  
Concealed shower mixer with shower head and shower set  
Mitigeur à encastrer avec douche de tête et kit de douche  
Miscelatore da incasso con soffione attacco e kit doccia

19BETER21102

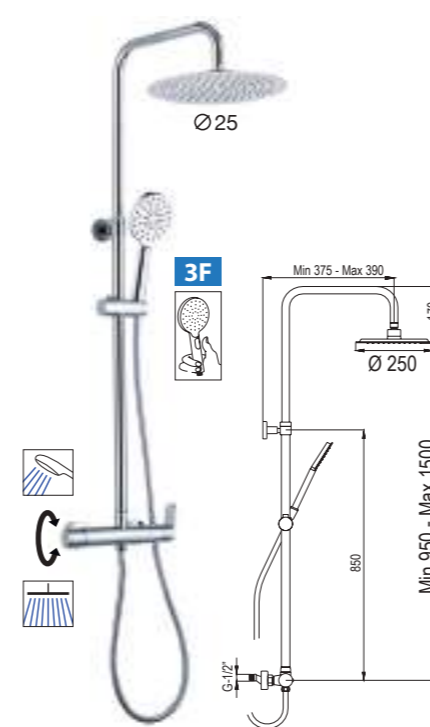
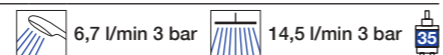

21NIR25BEA02



**Sistema de ducha monomando**  
Single lever mixer shower system  
Système de douche mitigeur  
Sistemi di doccia miscelatori

- Monomando con distribuidor incorporado
- Barra extensible de acero inoxidable AISI 304
- Flexo de acero inoxidable doble grapado, antitorsión, 1,70 m

- Single lever mixer with integrated distributor
- Stainless steel AISI 304 extensible bar
- Stainless steel flexible shower hose double hooked, anti-twist, 1,70 m
- Mitigeur avec distributeur intégré
- 4
- Barre extensible en acier inoxydable AISI 304
- Flexible en acier inoxydable double agrafage, anti-torsion, 1,70 m

- Miscelatore con distributore integrato
- Barra allungabile in acciaio inossidabile AISI 304
- Flessibile di doppia aggraffatura in acciaio inossidabile, anti-torsione, 1,70 m

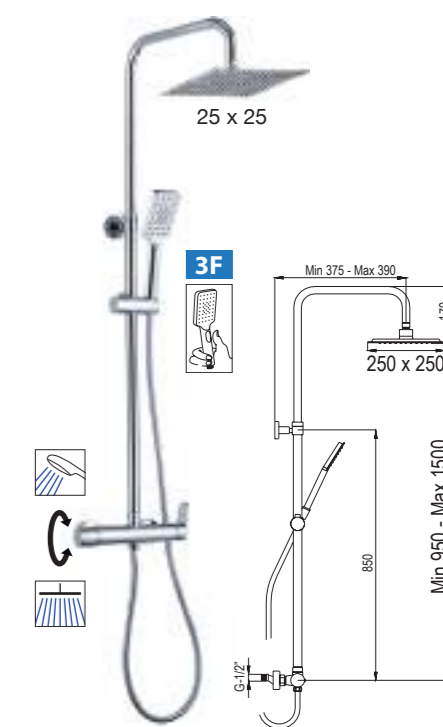

21NIC25BEA02





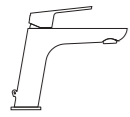

**BETA**

**GRIFERÍA DE BAÑO / BATHROOM FAUCETS**  
ROBINETTERIE POUR SALLE DE BAIN / RUBINETTERIA DA BAGNO



**Monomando de lavabo, negro**  
Single lever basin faucet, black  
Mitigeur de lavabo, noir  
Miscelatore per lavabo, nero

01BET100NG 6,7 l/min 3 bar  
01BET108NG 5 l/min 3 bar

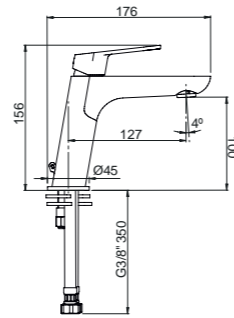

**Monomando de bidet, negro**  
Single lever bidet faucet, black  
Mitigeur de bidet, noir  
Miscelatore per bidet, nero

01BET200NG 8,3 l/min 3 bar

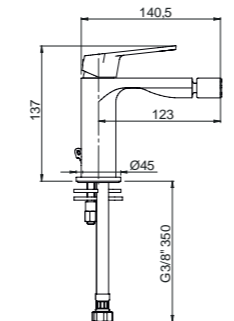

**Monomando de empotrar 2 vías, cromo**  
2 ways concealed shower mixer, chrome  
Mitigeur à encastrer 2 voies, chromé  
Miscelatore da incasso 2 vie, cromato

01BET351NG

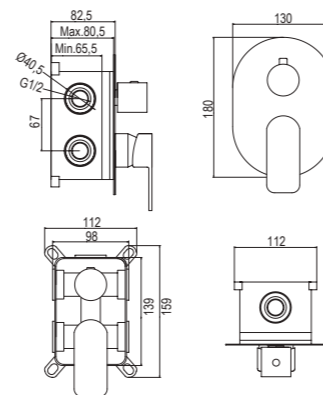

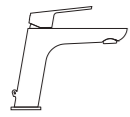

BETA

GRIFERÍA DE BAÑO / BATHROOM FAUCETS  
ROBINETTERIE POUR SALLE DE BAIN / RUBINETTERIA DA BAGNO

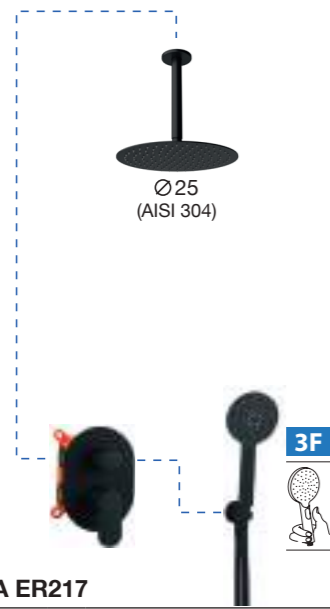

**KIT BETA ER217**

Monomando de empotrar con rociador y set de ducha  
Concealed shower mixer with shower head and shower set  
Mitigeur à encastrer avec douche de tête et kit de douche  
Miscelatore da incasso con soffione attacco e kit doccia

19BETER21705

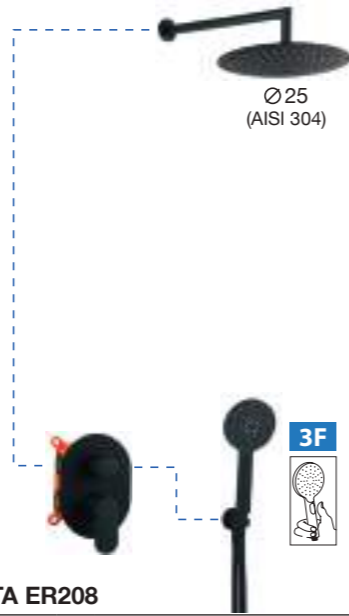

**KIT BETA ER208**

Monomando de empotrar con rociador y set de ducha  
Concealed shower mixer with shower head and shower set  
Mitigeur à encastrer avec douche de tête et kit de douche  
Miscelatore da incasso con soffione attacco e kit doccia

19BETER20805



OPCIONAL / OPTIONAL / OPTIONNEL / OPZIONALE

Reductor caudal 9 l/min ducha/rociador  
Flow rate reducer 9 l/min hand shower/shower head  
Réducteur débit 9 l/min douchette/douche de tête  
Riduttore portata da 9 l/min maniglia doccia/soffione

6024



**Sistema de ducha monomando / Single lever mixer shower system**  
Système de douche mitigeur / Sistemi di doccia miscelatori

- Monomando con distribuidor incorporado
- Rociador de Ø 25 cm, de acero inoxidable AISI 304
- Barra extensible de acero inoxidable AISI 304
- Flexo de PVC, antitorsión, 1,75 m
- Single lever mixer with integrated distributor
- Stainless steel AISI 304 shower head, Ø 25 cm
- Stainless steel AISI 304 extensible bar
- PVC flexible hose, anti-twist, 1,75 m
- Mitigeur avec distributeur intégré
- Douche de tête de Ø 25 cm, en acier inoxydable AISI 304
- Barre extensible en acier inoxydable AISI 304
- Flexible en PVC, anti-torsion, 1,75 m
- Miscelatore con distributore integrato
- Soffione Ø 25 cm, in acciaio inossidabile AISI 304
- Barra allungabile in acciaio inossidabile AISI 304
- Flessibile in PVC, anti-torsione, 1,75 m

21NITR25BEA05

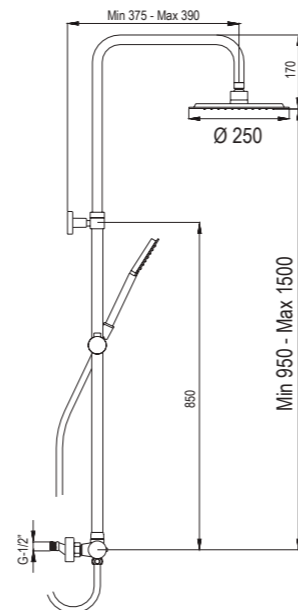
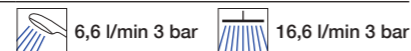



# VENT-i2

GRIFERÍA DE BAÑO  
BATHROOM FAUCETS  
ROBINETTERIE POUR SALLE DE BAIN  
RUBINETTERIA DA BAGNO

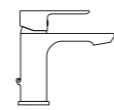

## VENT-i2

GRIFERÍA DE BAÑO / BATHROOM FAUCETS  
ROBINETTERIE POUR SALLE DE BAIN / RUBINETTERIA DA BAGNO



**Monomando de bidet, cromo**  
Single lever bidet faucet, chrome  
Mitigeur de bidet, chromé  
Miscelatore per bidet, cromato

01VE2200CR 15,8 l/min 3 bar

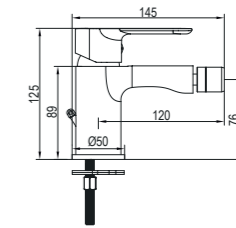

**Monomando de ducha, cromo**  
Single lever shower faucet, chrome  
Mitigeur de douche, chromé  
Miscelatore per doccia, cromato

**Sin equipo / Without equipment**  
Sans équipement / Senza equipaggiamento

01VE2300CR

**Con equipo A / With equipment A**  
Avec équipement A / Con equipaggiamento A

01VE2302CR 13,2 l/min 3 bar

NEW

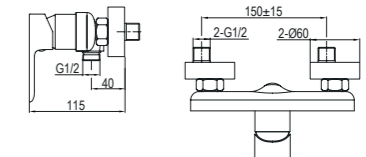

1F 170 cm.



**Monomando de bañera, cromo**  
Single lever bath faucet, chrome  
Mitigeur de baignoire, chromé  
Miscelatore per vasca, cromato

**Sin equipo / Without equipment**  
Sans équipement / Senza equipaggiamento

01VE2400CR 9,8 l/min 3 bar

**Con equipo A / With equipment A**  
Avec équipement A / Con equipaggiamento A

01VE2402CR 13,3 l/min 3 bar

NEW

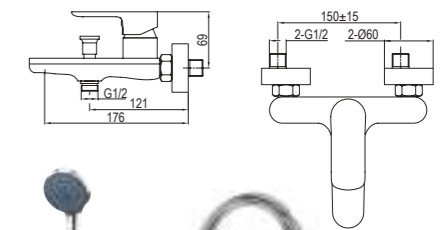

1F 170 cm.



**Monomando de lavabo, cromo**  
Single lever basin faucet, chrome  
Mitigeur de lavabo, chromé  
Miscelatore per lavabo, cromato

01VE2100CR 11,7 l/min 3 bar

01VE2108CR 5 l/min 3 bar

NEW

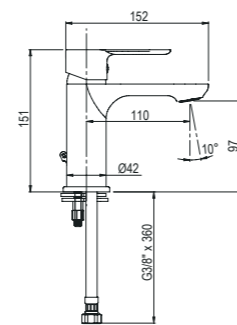

**Monomando lavabo de empotrar cromo**  
Concealed single lever basin mixer, chrome  
Mitigeur de lavabo à encastrer, chromé  
Miscelatore da incasso per lavabo, cromato

01VE2150CR 16,7 l/min 3 bar

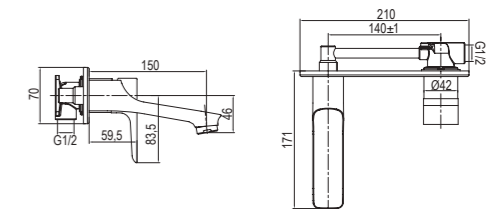

**Monomando alto de lavabo, cromo**  
High single lever basin faucet, chrome  
Mitigeur de lavabo haut, chromé  
Miscelatore per lavabo alto, cromato

01VE2120CR 12,5 l/min 3 bar

01VE2128CR 5 l/min 3 bar

NEW

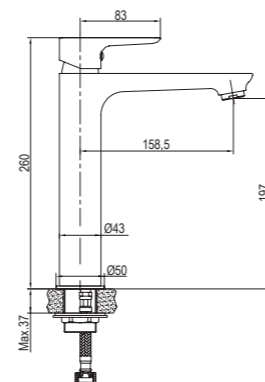

**Monomando fregadera**  
Single lever kitchen faucet  
Mitigeur d'évier  
Miscelatore per lavello

05MIV500CR 19,8 l/min 3 bar

05MIV509CR 5 l/min 3 bar

05MIV501CR 2P 6,5-13,2 l/min 3 bar

NEW

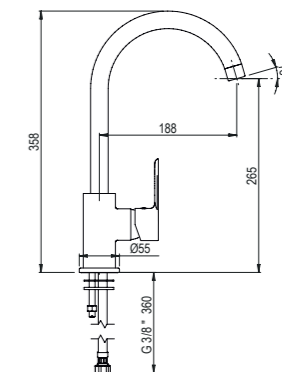



**Monomando de empotrar 1 vía, cromo**  
 1 way concealed shower mixer, chrome  
 Mitigeur à encastrer 1 voie, chromé  
 Miscelatore da incasso 1 via, cromato

01VE2350CR

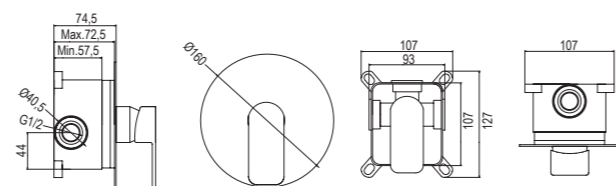

**Monomando de empotrar 2 vías, cromo**  
 2 ways concealed shower mixer, chrome  
 Mitigeur à encastrer 2 voies, chromé  
 Miscelatore da incasso 2 vie, cromato

01VE2351CR

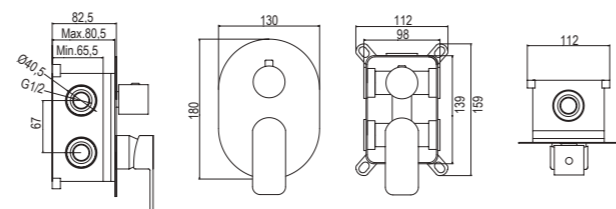

**Monomando de empotrar 3 vías, cromo**  
 3 ways concealed shower mixer, chrome  
 Mitigeur à encastrer 3 voies, chromé  
 Miscelatore da incasso 3 vie, cromato

01VE2352CR

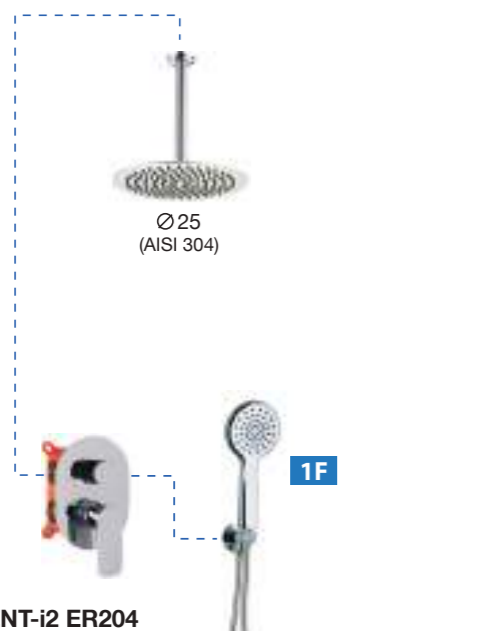
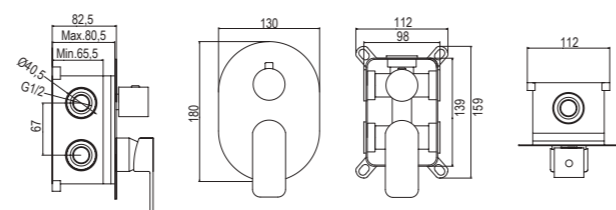

**KIT VENT-i2 ER204**

**Monomando de empotrar con rociador y set de ducha**  
 Concealed shower mixer with shower head and shower set  
 Mitigeur à encastrer avec douche de tête et kit de douche  
 Miscelatore da incasso con soffione attacco e kit doccia

19VE2ER20402



9,2 l/min 3 bar



14,5 l/min 3 bar



OPCIONAL / OPTIONAL / OPTIONNEL / OPZIONALE

**Reductor caudal 9 l/min ducha/rociador**

Flow rate reducer 9 l/min hand shower/shower head  
 Réducteur débit 9 l/min douchette/douche de tête  
 Riduttore portata da 9 l/min maniglia doccia/soffione

6024



9 l/min 3 bar



**KIT VENT-i2 ER205**

**Monomando de empotrar con rociador y set de ducha**  
 Concealed shower mixer with shower head and shower set  
 Mitigeur à encastrer avec douche de tête et kit de douche  
 Miscelatore da incasso con soffione attacco e kit doccia

19VE2ER20502



9,2 l/min 3 bar



14,5 l/min 3 bar



OPCIONAL / OPTIONAL / OPTIONNEL / OPZIONALE

**Reductor caudal 9 l/min ducha/rociador**

Flow rate reducer 9 l/min hand shower/shower head  
 Réducteur débit 9 l/min douchette/douche de tête  
 Riduttore portata da 9 l/min maniglia doccia/soffione

6024



9 l/min 3 bar



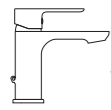

**Sistema de ducha monomando / Single lever mixer shower system**  
Système de douche mitigeur / Sistemi di doccia miscelatori

- Monomando con distribuidor incorporado
  - Rociador de Ø 20 cm, de acero inoxidable AISI 304
  - Barra extensible de acero inoxidable AISI 304
  - Flexo de acero inoxidable doble grapado, antitorsión, 1,70 m
- Single lever mixer with integrated distributor
  - Stainless steel AISI 304 shower head, Ø 20 cm
  - Stainless steel AISI 304 extensible bar
  - Stainless steel flexible shower hose double hooked, anti-twist, 1,70 m
- Mitigeur avec distributeur intégré
  - Douche de tête de Ø 20 cm, en acier inoxydable AISI 304
  - Barre extensible en acier inoxydable AISI 304
  - Flexible en acier inoxydable double agrafage, anti-torsion, 1,70 m
- Miscelatore con distributore integrato
  - Soffione Ø 20 cm, in acciaio inossidabile AISI 304
  - Barra allungabile in acciaio inossidabile AISI 304
  - Flessibile di doppia aggraffatura in acciaio inossidabile, anti-torsione, 1,70 m

21WBR20AMD02

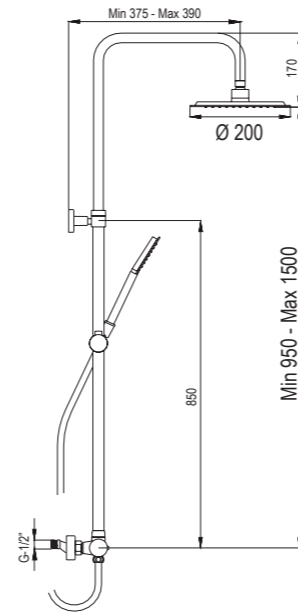

**OPCIONAL / OPTIONAL / OPTIONNEL / OPZIONALE**

**Kit 2 reductores caudal 9 l/min ducha/rociador**  
2 flow rate reducer kit 9 l/min hand shower/head shower  
Kit 2 réducteurs débit 9l/min douchette/douche de tête  
Kit 2 riduttori portata 9 l/min maniglia doccia/soffione

6024X2



**Sistema de ducha monomando / Single lever mixer shower system**  
Système de douche mitigeur / Sistemi di doccia miscelatori

- Monomando con distribuidor incorporado
  - Rociador de 20 x 20 cm, de acero inoxidable AISI 304
  - Barra extensible de acero inoxidable AISI 304
  - Flexo de acero inoxidable doble grapado, antitorsión, 1,70 m
- Single lever mixer with integrated distributor
  - Stainless steel AISI 304 shower head, 20 x 20 cm
  - Stainless steel AISI 304 extensible bar
  - Stainless steel flexible shower hose double hooked, anti-twist, 1,70 m
- Mitigeur avec distributeur intégré
  - Douche de tête de 20 x 20 cm, en acier inoxydable AISI 304
  - Barre extensible en acier inoxydable AISI 304
  - Flexible en acier inoxydable double agrafage, anti-torsion, 1,70 m
- Miscelatore con distributore integrato
  - Soffione 20 x 20 cm, in acciaio inossidabile AISI 304
  - Barra allungabile in acciaio inossidabile AISI 304
  - Flessibile di doppia aggraffatura in acciaio inossidabile, anti-torsione, 1,70 m

21WBC20AMD02

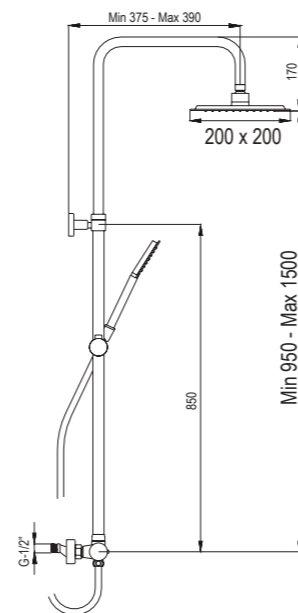

# LILE



GRIFERÍA DE BAÑO  
BATHROOM FAUCETS  
ROBINETTERIE POUR SALLE DE BAIN  
RUBINETTERIA DA BAGNO



**Monomando de lavabo, cromo**  
Single lever basin faucet, chrome  
Mitigeur de lavabo, chromé  
Miscelatore per lavabo, cromato

- 01LIL100CR 8,3 l/min 3 bar
- 01LIL108CR 5 l/min 3 bar

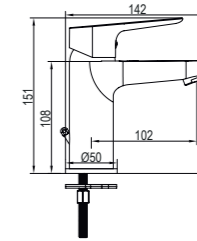

**Monomando de bidet, cromo**  
Single lever bidet faucet, chrome  
Mitigeur de bidet, chromé  
Miscelatore per bidet, cromato

- 01LIL200CR 15,8 l/min 3 bar

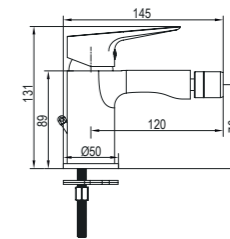

**Monomando de ducha, cromo**  
Single lever shower faucet, chrome  
Mitigeur de douche, chromé  
Miscelatore per doccia, cromato

**Sin equipo / Without equipment**  
Sans équipement / Senza equipaggiamento

- 01LIL300CR

**Con equipo G / With equipment G**  
Avec équipement G / Con equipaggiamento G

- 01LIL301CR 16,7 l/min 3 bar
- 01LIL318CR 9 l/min 3 bar

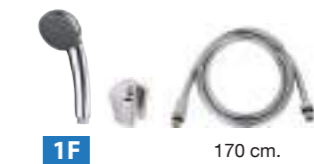
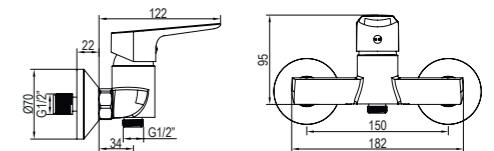

**Monomando de bañera, cromo**  
Single lever bath faucet, chrome  
Mitigeur de baignoire, chromé  
Miscelatore per vasca, cromato

**Sin equipo / Without equipment**  
Sans équipement / Senza equipaggiamento

- 01LIL400CR 19,6 l/min 3 bar

**Con equipo G / With equipment G**  
Avec équipement G / Con equipaggiamento G

- 01LIL401CR 13,6 l/min 3 bar
- 01LIL418CR 9,4 l/min 3 bar

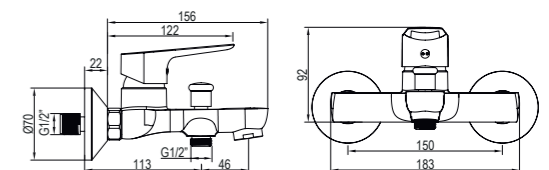



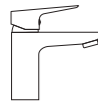

LILE

GRIFERÍA DE BAÑO / BATHROOM FAUCETS  
ROBINETTERIE POUR SALLE DE BAIN / RUBINETTERIA DA BAGNO



**LILE**

**Monomando fregadera**  
Single lever kitchen faucet  
Mitigeur d'évier  
Miscelatore per lavello

05LIL500CR 19,8 l/min 3 bar

05LIL509CR 5 l/min 3 bar

05LIL501CR 2P 6,5-13,2 l/min 3 bar

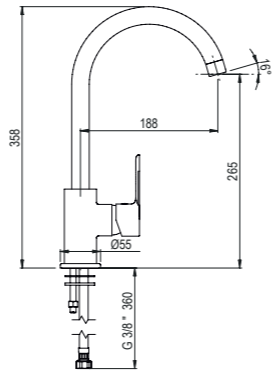

**Monomando de empotrar 1 vía, cromo**  
1 way concealed shower mixer, chrome  
Mitigeur à encastrer 1 voie, chromé  
Miscelatore da incasso 1 vía, cromato

01LIL350CR

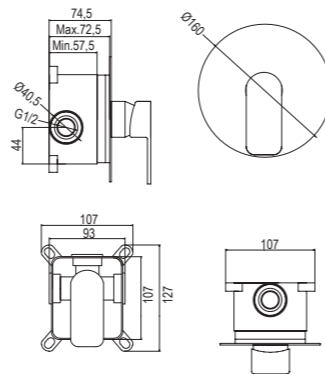

**Monomando de empotrar 2 vías, cromo**  
2 ways concealed shower mixer, chrome  
Mitigeur à encastrer 2 voies, chromé  
Miscelatore da incasso 2 vie, cromato

01LIL351CR

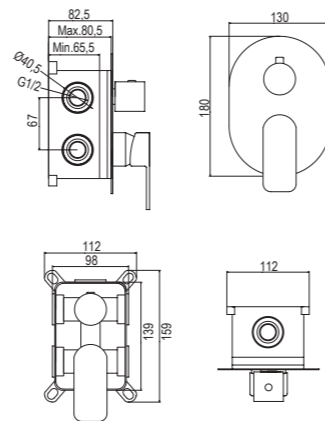

**Monomando de empotrar 3 vías, cromo**  
3 ways concealed shower mixer, chrome  
Mitigeur à encastrer 3 voies, chromé  
Miscelatore da incasso 3 vie, cromato

01LIL352CR

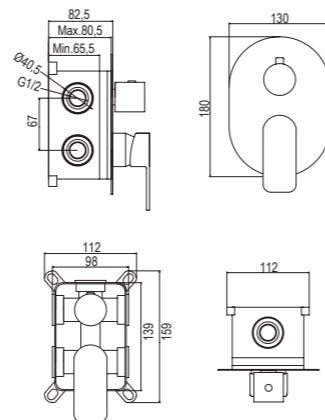

**KIT LILE ER204**

**Monomando de empotrar con rociador y set de ducha**  
Concealed shower mixer with shower head and shower set  
Mitigeur à encastrer avec douche de tête et kit de douche  
Miscelatore da incasso con soffione attacco e kit doccia

19LILER20402



**KIT LILE ER205**

**Monomando de empotrar con rociador y set de ducha**  
Concealed shower mixer with shower head and shower set  
Mitigeur à encastrer avec douche de tête et kit de douche  
Miscelatore da incasso con soffione attacco e kit doccia

19LILER20502



**OPCIONAL / OPTIONAL / OPTIONNEL / OPZIONALE**

**Kit 2 reductores caudal 9 l/min ducha/rociador**  
2 flow rate reducer kit 9 l/min hand shower/head shower  
Kit 2 réducteurs débit 9l/min douchette/douche de tête  
Kit 2 riduttori portata 9 l/min maniglia doccia/soffione

6024X2



**OPCIONES DE ROCIADOR**  
SHOWER HEAD OPTIONS  
OPTIONS POUR DOUCHE DE TÊTE  
OPZIONI PER SOFFIONE

**Wind Blu RD**

en ABS  
in ABS  
en ABS  
in ABS  
Ø 24 cm

21WBR24LIA01



**Atlas R20**

en AISI 304  
in AISI304  
en AISI 304  
in AISI 304  
Ø 20 cm

21WBR20LIA02



**Atlas R25**

en AISI 304  
in AISI304  
en AISI 304  
in AISI 304  
Ø 25 cm

21WBR25LIA02

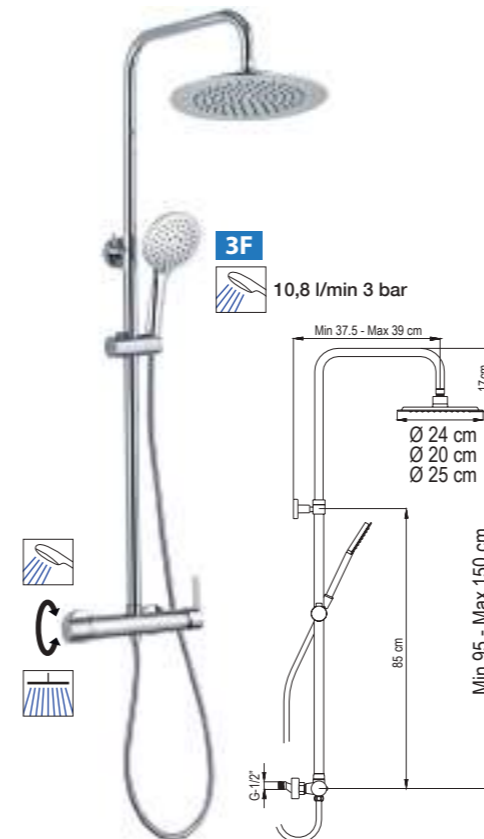

**Sistema de ducha monomando**

Single lever mixer shower system  
Système de douche mitigeur  
Sistemi di doccia miscelatori

- Monomando con distribuidor incorporado
- Barra extensible de acero inoxidable AISI 304
- Flexo de acero inoxidable doble grapado, antitorsión, 1,70 m

- Single lever mixer with integrated distributor
- Stainless steel AISI 304 extensible bar
- Stainless steel flexible shower hose double hooked, anti-twist, 1,70 m

- Mitigeur avec distributeur intégré
- Barre extensible en acier inoxydable AISI 304
- Flexible en acier inoxydable double agrafage, anti-torsion, 1,70 m

- Miscelatore con distributore integrato
- Barra allungabile in acciaio inossidabile AISI 304
- Flessibile di doppia aggraffatura in acciaio inossidabile, anti-torsione, 1,70 m

# SKY

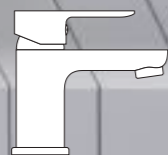

GRIFERÍA DE BAÑO  
BATHROOM FAUCETS  
ROBINETTERIE POUR SALLE DE BAIN  
RUBINETTERIA DA BAGNO





**SKY**



**Monomando de bidet, cromo**  
Single lever bidet faucet, chrome  
Mitigeur de bidet, chromé  
Miscelatore per bidet, cromato

01SKY200CR 15,8 l/min 3 bar

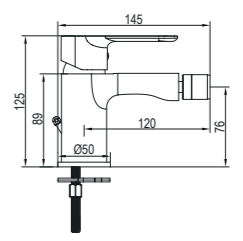

**Monomando de ducha, cromo**  
Single lever shower faucet, chrome  
Mitigeur de douche, chromé  
Miscelatore per doccia, cromato

Sin equipo / Without equipment  
Sans équipement / Senza equipaggiamento

01SKY300CR

Con equipo G / With equipment G  
Avec équipement G / Con equipaggiamento G

01SKY301CR 16,7 l/min 3 bar

01SKY318CR 9 l/min 3 bar

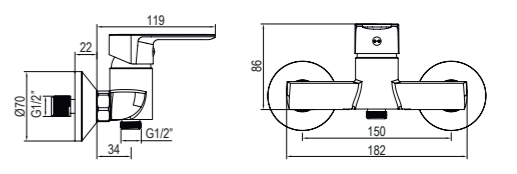

1F

170 cm.



**Monomando de bañera, cromo**  
Single lever bath faucet, chrome  
Mitigeur de baignoire, chromé  
Miscelatore per vasca, cromato

Sin equipo / Without equipment  
Sans équipement / Senza equipaggiamento

01SKY400CR 19,6 l/min 3 bar

Con equipo G / With equipment G  
Avec équipement G / Con equipaggiamento G

01SKY401CR 13,6 l/min 3 bar

01SKY418CR 9,4 l/min 3 bar

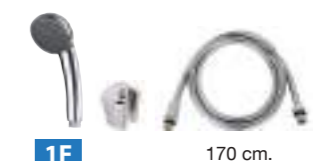
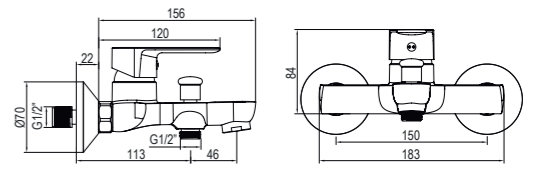

1F

170 cm.



**Monomando fregadera**  
Single lever kitchen faucet  
Mitigeur d'évier  
Miscelatore per lavello

05MIS500CR 19,8 l/min 3 bar

05MIS509CR 5 l/min 3 bar

05MIS501CR 2P 6,5-13,2 l/min 3 bar

NEW

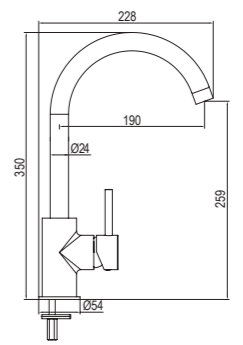

**Monomando de lavabo, cromo**  
Single lever basin faucet, chrome  
Mitigeur de lavabo, chromé  
Miscelatore per lavabo, cromato

01SKY100CR 10 l/min 3 bar

01SKY108CR 5 l/min 3 bar

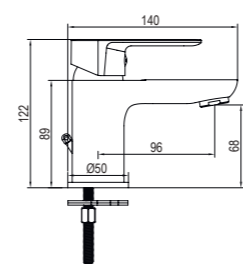

**Monomando fregadera**  
Single lever kitchen faucet  
Mitigeur d'évier  
Miscelatore per lavello

05SKY505CR 13,5 l/min 3 bar

05SKY509CR 5 l/min 3 bar

NEW

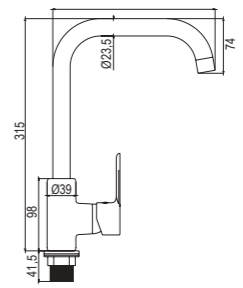



**Monomando de empotrar 1 vía, cromo**  
1 way concealed shower mixer, chrome  
Mitigeur à encastrer 1 voie, chromé  
Miscelatore da incasso 1 via, cromato

01SKY350CR

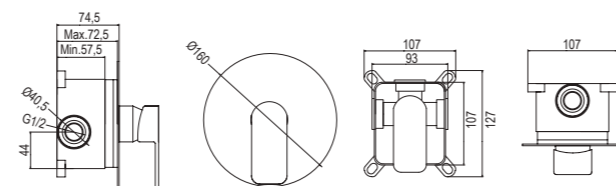

**Monomando de empotrar 2 vías, cromo**  
2 ways concealed shower mixer, chrome  
Mitigeur à encastrer 2 voies, chromé  
Miscelatore da incasso 2 vie, cromato

01SKY351CR

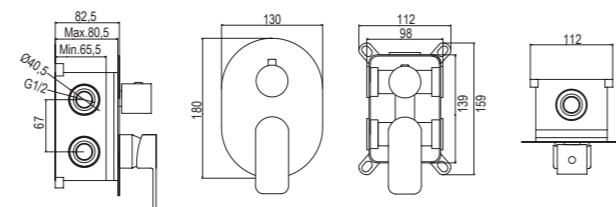

**Monomando de empotrar 3 vías, cromo**  
3 ways concealed shower mixer, chrome  
Mitigeur à encastrer 3 voies, chromé  
Miscelatore da incasso 3 vie, cromato

01SKY352CR

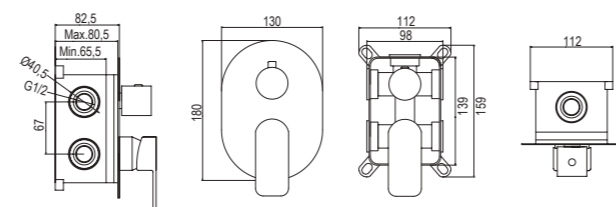
GRIFERÍA DE BAÑO / BATHROOM FAUCETS  
ROBINETTERIE POUR SALLE DE BAIN / RUBINETTERIA DA BAGNO

**Sistema de ducha monomando / Single lever mixer shower system**  
Système de douche mitigeur / Sistemi di doccia miscelatori

- Monomando con distribuidor incorporado
- Rociador de Ø 20 cm, de ABS
- Barra extensible de acero inoxidable AISI 304
- Flexo de acero inoxidable doble grapado, antitorsi3n, 1,70 m

- Single lever mixer with integrated distributor
- ABS shower head, Ø 20 cm
- Stainless steel AISI 304 extensible bar
- Stainless steel flexible shower hose double hooked, anti-twist, 1,70 m

- Mitigeur avec distributeur int3gr3
- Douche de t3te de Ø 20 cm, en ABS
- Barre extensible en acier inoxydable AISI 304
- Flexible en acier inoxydable double agrafage, anti-torsion, 1,70 m

- Miscelatore con distributore integrato
- Soffione Ø 20 cm, in ABS
- Barra allungabile in acciaio inossidabile AISI 304
- Flessibile di doppia aggraffatura in acciaio inossidabile, anti-torsione, 1,70 m

21NPSKA01



10 l/min 3 bar



16,5 l/min 3 bar

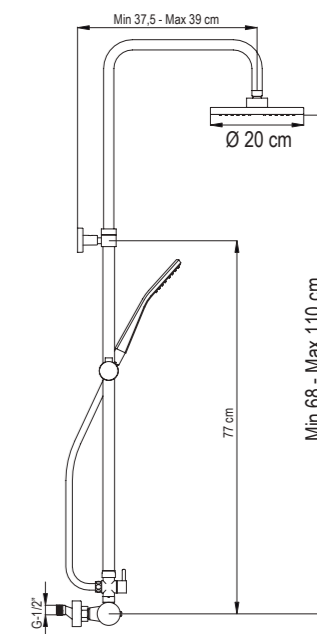

OPCIONAL / OPTIONAL / OPTIONNEL / OPZIONALE

**Kit 2 reductores caudal 9 l/min ducha/rociador**  
2 flow rate reducer kit 9 l/min hand shower/head shower  
Kit 2 r3ducteurs d3bit 9l/min douchette/douche de t3te  
Kit 2 riduttori portata 9 l/min maniglia doccia/soffione

6024X2



9 l/min 3 bar



9 l/min 3 bar

**Sistema de ducha monomando / Single lever mixer shower system**  
Système de douche mitigeur / Sistemi di doccia miscelatori

- Monomando con distribuidor incorporado
- Rociador de 20 x 20 cm, de ABS
- Barra extensible de acero inoxidable AISI 304
- Flexo de acero inoxidable doble grapado, antitorsi3n, 1,70 m

- Single lever mixer with integrated distributor
- ABS shower head, 20 x 20 cm
- Stainless steel AISI 304 extensible bar
- Stainless steel flexible shower hose double hooked, anti-twist, 1,70 m

- Mitigeur avec distributeur int3gr3
- Douche de t3te de 20 x 20 cm, en ABS
- Barre extensible en acier inoxydable AISI 304
- Flexible en acier inoxydable double agrafage, anti-torsion, 1,70 m

- Miscelatore con distributore integrato
- Soffione 20 x 20 cm, in ABS
- Barra allungabile in acciaio inossidabile AISI 304
- Flessibile di doppia aggraffatura in acciaio inossidabile, anti-torsione, 1,70 m

21NOSKA01



12,5 l/min 3 bar



15,4 l/min 3 bar

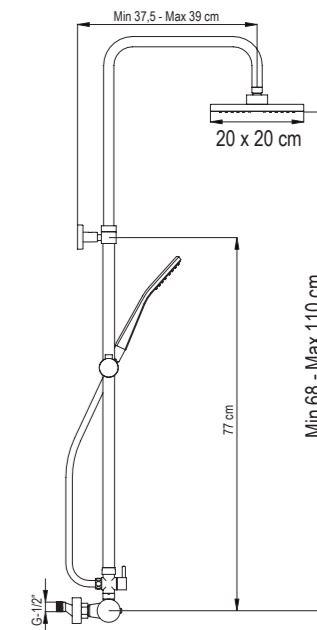

## KIT SKY ER204

**Monomando de empotrar con rociador y set de ducha**  
Concealed shower mixer with shower head and shower set  
Mitigeur à encastrer avec douche de t3te et kit de douche  
Miscelatore da incasso con soffione attacco e kit doccia

19SKYER20402



9,2 l/min 3 bar



14,5 l/min 3 bar



OPCIONAL / OPTIONAL / OPTIONNEL / OPZIONALE

**Reductor caudal 9 l/min ducha y/o rociador**  
Flow rate reducer 9 l/min hand shower and/or shower head  
R3ducteur d3bit 9 l/min douchette et/ou douche de t3te  
Riduttore portata da 9 l/min maniglia doccia e/o soffione

6024



9 l/min 3 bar

## KIT SKY ER205

**Monomando de empotrar con rociador y set de ducha**  
Concealed shower mixer with shower head and shower set  
Mitigeur à encastrer avec douche de t3te et kit de douche  
Miscelatore da incasso con soffione attacco e kit doccia

19SKYER20502



9,2 l/min 3 bar



14,5 l/min 3 bar



OPCIONAL / OPTIONAL / OPTIONNEL / OPZIONALE

**Reductor caudal 9 l/min ducha y/o rociador**  
Flow rate reducer 9 l/min hand shower and/or shower head  
R3ducteur d3bit 9 l/min douchette et/ou douche de t3te  
Riduttore portata da 9 l/min maniglia doccia e/o soffione

6024



9 l/min 3 bar



**SALT**

GRIFERÍA DE BAÑO / BATHROOM FAUCETS  
ROBINETTERIE POUR SALLE DE BAIN / RUBINETTERIA DA BAGNO

GRIFERÍA DE BAÑO  
BATHROOM FAUCETS



**Monomando de lavabo, cromo**  
Single lever basin faucet, chrome  
Mitigeur de lavabo, chromé  
Miscelatore per lavabo, cromo

01SAL100CR 15 l/min 3 bar

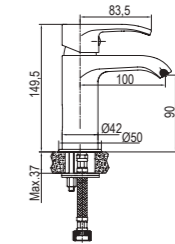

**Monomando de bidet, cromo**  
Single lever bidet faucet, chrome  
Mitigeur de bidet, chromé  
Miscelatore per bidet, cromo

01SAL200CR 15,8 l/min 3 bar

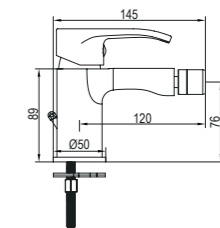

**Monomando de ducha, cromo**  
Single lever shower faucet, chrome  
Mitigeur de douche, chromé  
Miscelatore per doccia, cromo

**Sin equipo / Without equipment**  
Sans équipement / Senza equipaggiamento

01SAL300CR

**Con equipo A / With equipment A**  
Avec équipement A / Con equipaggiamento A

01SAL302CR 14,2 l/min 3 bar

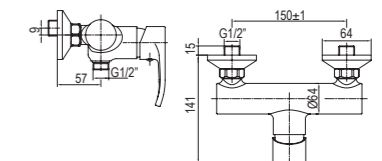

1F

170 cm.



**Monomando de bañera, cromo**  
Single lever bath faucet, chrome  
Mitigeur de baignoire, chromé  
Miscelatore per vasca, cromo

**Sin equipo / Without equipment**  
Sans équipement / Senza equipaggiamento

01SAL400CR 21,7 l/min 3 bar

**Con equipo A / With equipment A**  
Avec équipement A / Con equipaggiamento A

01SAL402CR 13,5 l/min 3 bar

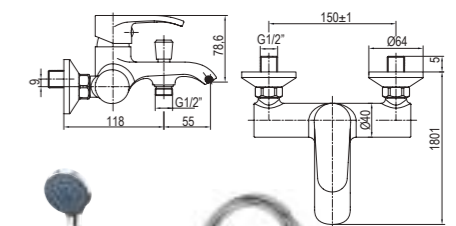

1F

170 cm.



**Monomando de lavabo, cromo**  
Single lever basin faucet, chrome  
Mitigeur de lavabo, chromé  
Miscelatore per lavabo, cromato

01BAS100CR 15,8 l/min 3 bar  
01BAS101CR **2P** 6,6-14,1 l/min 3 bar

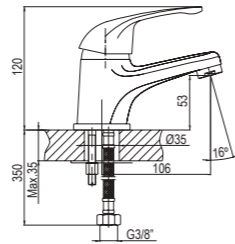

**Monomando de bidet, cromo**  
Single lever bidet faucet, chrome  
Mitigeur de bidet, chromé  
Miscelatore per bidet, cromato

01BAS200CR 15,2 l/min 3 bar

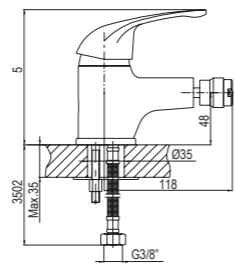

**Monomando de ducha, cromo**  
Single lever shower faucet, chrome  
Mitigeur de douche, chromé  
Miscelatore per doccia, cromato

**Sin equipo / Without equipment**  
Sans équipement / Senza equipaggiamento  
01BAS300CR

**Con equipo G / With equipment G**  
Avec équipement G / Con equipaggiamento G  
01BAS301CR 15 l/min 3 bar  
01BAS318CR **9** l/min 3 bar

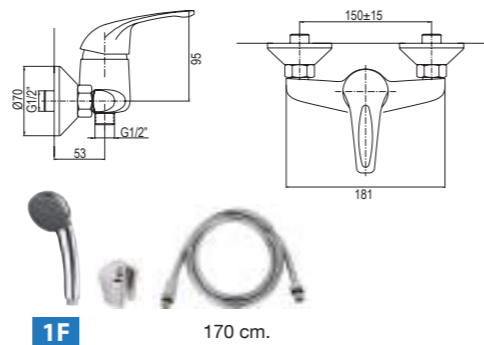

**Monomando de bañera, cromo**  
Single lever bath faucet, chrome  
Mitigeur de baignoire, chromé  
Miscelatore per vasca, cromato

**Sin equipo / Without equipment**  
Sans équipement / Senza equipaggiamento  
01BAS400CR **15** l/min 3 bar

**Con equipo G / With equipment G**  
Avec équipement G / Con equipaggiamento G  
01BAS401CR 14 l/min 3 bar  
01BAS418CR **9** l/min 3 bar

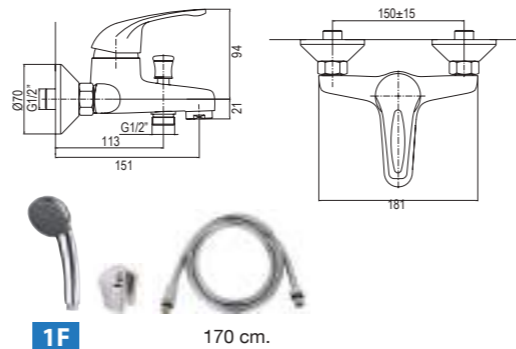

**Bimando lavabo, cromo**  
Double handle basin faucet, chrome  
Mélangeur de lavabo, chromé  
Bicomando per lavabo, cromato

02BRI100CR 21,7 l/min 3 bar



**Bimando bidet, cromo**  
Double handle bidet faucet, chrome  
Mélangeur de bidet, chromé  
Bicomando per bidet, cromato

02BRI200CR 20,8 l/min 3 bar



**Bimando ducha, cromo**  
Double handle shower faucet, chrome  
Mélangeur de douche, chromé  
Bicomando per doccia, cromato

**Sin equipo / Without equipment**  
Sans équipement / Senza equipaggiamento  
02BRI300CR

**Con equipo K / With equipment K**  
Avec équipement K / Con equipaggiamento K  
02BRI312CR 15 l/min 3 bar



**Bimando bañera, cromo**  
Double handle bath faucet, chrome  
Mélangeur de baignoire, chromé  
Bicomando per vasca, cromato

**Sin equipo / Without equipment**  
Sans équipement / Senza equipaggiamento  
02BRI400CR **22,3** l/min 3 bar

**Con equipo L / With equipment L**  
Avec équipement L / Con equipaggiamento L  
02BRI413CR 15 l/min 3 bar

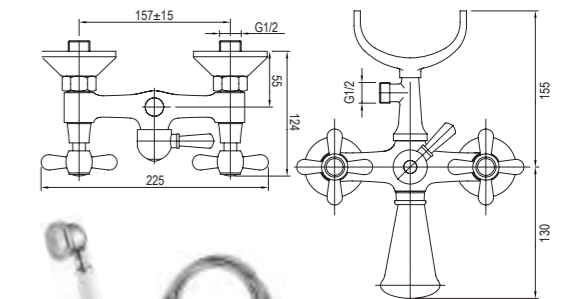
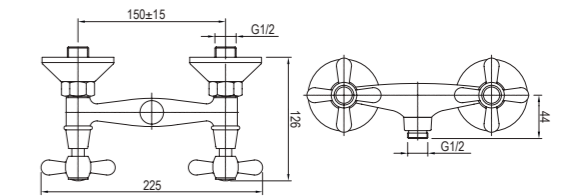
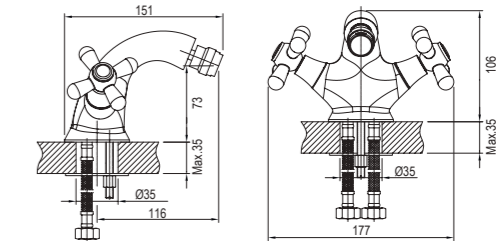
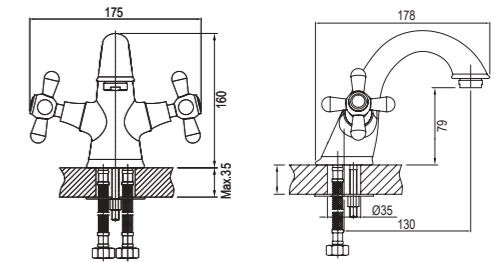



**SISTEMAS DE DUCHA Y BAÑO**  
**SHOWER AND BATH SYSTEMS**  
**SYSTÈMES DE DOUCHE ET BAIN**  
**SISTEMI DI DOCCIA E VASCA**

LUXOR



**OPCIONES DE ROCIADOR**  
**SHOWER HEAD OPTIONS**  
**OPTIONS POUR DOUCHE DE TÊTE**  
**OPZIONI PER SOFFIONE**

**Con rociador Atlas C20, de acero inoxidable AISI 304, ultrafino, 20 x 20 cm**  
 With Atlas C20 shower head, in stainless steel AISI 304, ultraslim, 20 x 20 cm  
 Avec douche de tête Atlas C20, en acier inoxydable AISI 304, ultrafine, 20 x 20 cm  
 Con soffione Atlas C20, in acciaio inossidabile AISI 304, ultrasottile, 20 x 20 cm

**20 x 20 cm**

**12,5 l/min 3 bar** **21LUC20LUD02**

**Con rociador Atlas C25, de acero inoxidable AISI 304, ultrafino, 25 x 25 cm**  
 With Atlas C25 shower head, in stainless steel AISI 304, ultraslim, 25 x 25 cm  
 Avec douche de tête Atlas C25, en acier inoxydable AISI 304, ultrafine, 25 x 25 cm  
 Con soffione Atlas C25, in acciaio inossidabile AISI 304, ultrasottile, 25 x 25 cm

**25 x 25 cm**

**12,5 l/min 3 bar** **21LUC25LUD02**

**OPCIONAL / OPTIONAL / OPTIONNEL / OPZIONALE**

**Kit 2 reductores caudal 9 l/min ducha/rociador**  
 2 flow rate reducer kit 9 l/min hand shower/head shower  
 Kit 2 réducteurs débit 9 l/min douchette/douche de tête  
 Kit 2 riduttori portata 9 l/min maniglia doccia/soffione

6024X2



- Monomando con distribuidor incorporado
- Barra extensible de acero inoxidable
- Flexo de acero inoxidable doble grapado, antitorsión, 1,70 m
- Single lever mixer with integrated distributor
- Stainless steel extensible bar
- Stainless steel flexible hose double hooked, anti-twist, 1,70 m
- Mitigreur avec distributeur intégré
- Barre extensible en acier inoxydable
- Flexible en acier inoxydable double agrafage, anti-torsion, 1,70 m
- Miscelatore con distributore integrato
- Barra allungabile in acciaio inossidabile
- Flessibile di doppia aggraffatura in acciaio inossidabile, anti-torsione, 1,70 m

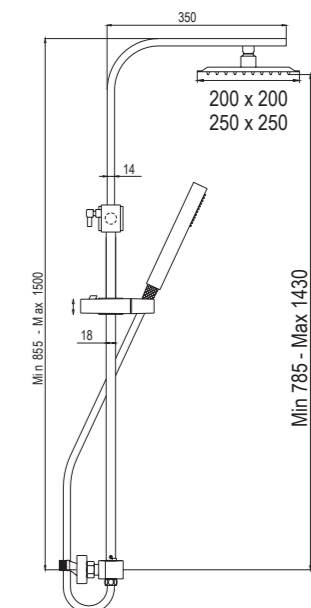



WIND BLU RD



OPCIONES DE ROCIADOR  
 SHOWER HEAD OPTIONS  
 OPTIONS POUR DOUCHE DE TÊTE  
 OPZIONI PER SOFFIONE

**Con rociador Wind Blu RD, de ABS, Ø 24 cm**  
 With Wind Blu RD shower head, in ABS, Ø 24 cm  
 Avec douche de tête Wind Blu RD, en ABS, Ø 24 cm  
 Con soffione Wind Blu RD, in ABS, Ø 24 cm

 15,8 l/min 3 bar
 **21WBR24AMD01**

**Con rociador Atlas R20, de acero inoxidable AISI 304, ultrafino, Ø 20 cm**  
 With Atlas R20 shower head, in stainless steel AISI 304, ultraslim, Ø 20 cm  
 Avec douche de tête Atlas R20, en acier inoxydable AISI 304, ultrafine, Ø 20 cm  
 Con soffione Atlas R20, in acciaio inossidabile AISI 304, ultrasottile, Ø 20 cm



 16,6 l/min 3 bar
 **21WBR20AMD02**

**Con rociador Atlas R25, de acero inoxidable AISI 304, ultrafino, Ø 25 cm**  
 With Atlas R25 shower head, in stainless steel AISI 304, ultraslim, Ø 25 cm  
 Avec douche de tête Atlas R25, en acier inoxydable AISI 304, ultrafine, Ø 25 cm  
 Con soffione Atlas R25, in acciaio inossidabile AISI 304, ultrasottile, Ø 25 cm

 16,6 l/min 3 bar
 **21WBR25AMD02**

OPCIONAL / OPTIONAL / OPTIONNEL / OPZIONALE

**Kit 2 reductores caudal 9 l/min ducha/rociador**  
 2 flow rate reducer kit 9 l/min hand shower/head shower  
 Kit 2 réducteurs débit 9l/min douchette/douche de tête  
 Kit 2 riduttori portata 9 l/min maniglia doccia/soffione

**6024X2**
 9 l/min 3 bar
  9 l/min 3 bar

- Monomando con distribuidor incorporado
- Barra extensible de acero inoxidable AISI 304
- Flexo de acero inoxidable doble grapado, antitorsión, 1,70 m

- Single lever mixer with integrated distributor
- Stainless steel AISI 304 extensible bar
- Stainless steel flexible hose double hooked, anti-twist, 1,70 m

- Mitigeur avec distributeur intégré
- Barre extensible en acier inoxydable AISI 304
- Flexible en acier inoxydable double agrafage, anti-torsion, 1,70 m

- Miscelatore con distributore integrato
- Barra allungabile in acciaio inossidabile AISI 304
- Flessibile di doppia aggraffatura in acciaio inossidabile, anti-torsione, 1,70 m

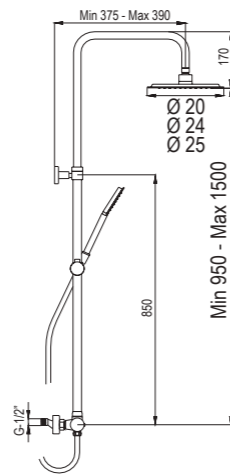



WIND BLU SQ

OPCIONES DE ROCIADOR  
 SHOWER HEAD OPTIONS  
 OPTIONS POUR DOUCHE DE TÊTE  
 OPZIONI PER SOFFIONE



22,5 x 22,5 cm



17 l/min 3 bar

Con rociador Wind Blu SQ, de ABS, 22,5 x 22,5 cm  
 With Wind Blu SQ shower head, in ABS, 22,5 x 22,5 cm  
 Avec douche de tête Wind Blu SQ, en ABS, 22,5 x 22,5 cm  
 Con soffione Wind Blu SQ, in ABS, 22,5 x 22,5 cm

21WBC22AMD01



20 x 20 cm



16,6 l/min 3 bar

Con rociador Atlas C20, de acero inoxidable AISI 304, ultrafino, 20 x 20 cm  
 With Atlas C20 shower head, in stainless steel AISI 304, ultraslim, 20 x 20 cm  
 Avec douche de tête Atlas C20, en acier inoxydable AISI 304, ultrafine, 20 x 20 cm  
 Con soffione Atlas C20, in acciaio inossidabile AISI 304, ultrasottile, 20 x 20 cm

21WBC20AMD02



25 x 25 cm



18,3 l/min 3 bar

Con rociador Atlas C25, de acero inoxidable AISI 304, ultrafino, 25 x 25 cm  
 With Atlas C25 shower head, in stainless steel AISI 304, ultraslim, 25 x 25 cm  
 Avec douche de tête Atlas C25, en acier inoxydable AISI 304, ultrafine, 25 x 25 cm  
 Con soffione Atlas C25, in acciaio inossidabile AISI 304, ultrasottile, 25 x 25 cm

21WBC25AMD02

OPCIONAL / OPTIONAL / OPTIONNEL / OPZIONALE

Kit 2 reductores caudal 9 l/min ducha/rociador  
 2 flow rate reducer kit 9 l/min hand shower/head shower  
 Kit 2 réducteurs débit 9l/min douchette/douche de tête  
 Kit 2 riduttori portata 9 l/min maniglia doccia/soffione

6024X2



9 l/min 3 bar



9 l/min 3 bar



1F

12 l/min 3 bar



- Monomando con distribuidor incorporado
- Barra extensible de acero inoxidable AISI 304
- Flexo de acero inoxidable doble grapado, antitorsión, 1,70 m
- Single lever mixer with integrated distributor
- Stainless steel AISI 304 extensible bar
- Stainless steel flexible hose double hooked, anti-twist, 1,70 m
- Mitigeur avec distributeur intégré
- Barre extensible en acier inoxydable AISI 304
- Flexible en acier inoxydable double agrafage, anti-torsion, 1,70 m
- Miscelatore con distributore integrato
- Barra allungabile in acciaio inossidabile AISI 304
- Flessibile di doppia aggraffatura in acciaio inossidabile, anti-torsione, 1,70 m

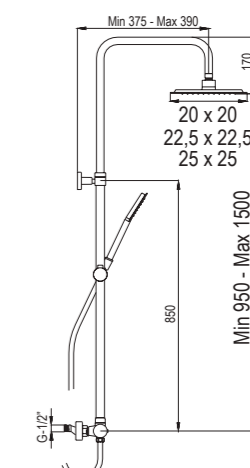

WIND BLU SQ



OPCIONES DE ROCIADOR  
 SHOWER HEAD OPTIONS  
 OPTIONS POUR DOUCHE DE TÊTE  
 OPZIONI PER SOFFIONE

Wind Blu SQ

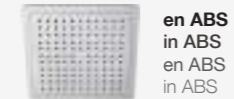

22,5 x 22,5 cm

21WBC22SUD01

Atlas C20



20 x 20 cm

21WBC20SUD02

Atlas C25



25 x 25 cm

21WBC25SUD02

en ABS  
 in ABS  
 en ABS  
 in ABS

AISI 304  
 ultrafino  
 ultraslim  
 ultrafine  
 ultrasottile

AISI 304  
 ultrafino  
 ultraslim  
 ultrafine  
 ultrasottile

WIND BLU RD



OPCIONES DE ROCIADOR  
 SHOWER HEAD OPTIONS  
 OPTIONS POUR DOUCHE DE TÊTE  
 OPZIONI PER SOFFIONE

Wind Blu RD



Ø 24 cm

21WBR24SUD01

Atlas R20



Ø 20 cm

21WBR20SUD02

Atlas R25



Ø 25 cm

21WBR25SUD02

en ABS  
 in ABS  
 en ABS  
 in ABS

AISI 304  
 ultrafino  
 ultraslim  
 ultrafine  
 ultrasottile

AISI 304  
 ultrafino  
 ultraslim  
 ultrafine  
 ultrasottile

- Monomando con distribuidor incorporado
- Barra extensible de acero inoxidable AISI 304
- Flexo de acero inoxidable doble grapado, antitorsión, 1,70 m

- Single lever mixer with integrated distributor
- Stainless steel AISI 304 extensible bar
- Stainless steel flexible hose double hooked, anti-twist, 1,70 m

- Mitigeur avec distributeur intégré
- Barre extensible en acier inoxydable AISI 304
- Flexible en acier inoxydable double agrafage, anti-torsion, 1,70 m

- Miscelatore con distributore integrato
- Barra allungabile in acciaio inossidabile AISI 304
- Flessibile di doppia aggraffatura in acciaio inossidabile, anti-torsione, 1,70 m

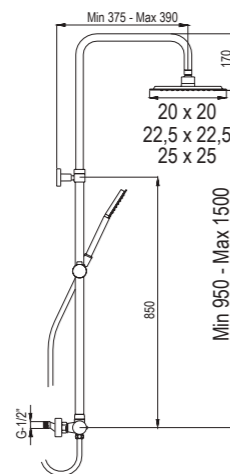

- Monomando con distribuidor incorporado
- Barra extensible de acero inoxidable AISI 304
- Flexo de acero inoxidable doble grapado, antitorsión, 1,70 m

- Single lever mixer with integrated distributor
- Stainless steel AISI 304 extensible bar
- Stainless steel flexible hose double hooked, anti-twist, 1,70 m

- Mitigeur avec distributeur intégré
- Barre extensible en acier inoxydable AISI 304
- Flexible en acier inoxydable double agrafage, anti-torsion, 1,70 m

- Miscelatore con distributore integrato
- Barra allungabile in acciaio inossidabile AISI 304
- Flessibile di doppia aggraffatura in acciaio inossidabile, anti-torsione, 1,70 m

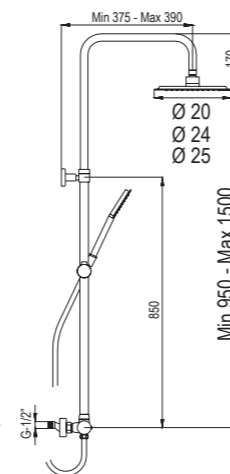

NEW OCEAN

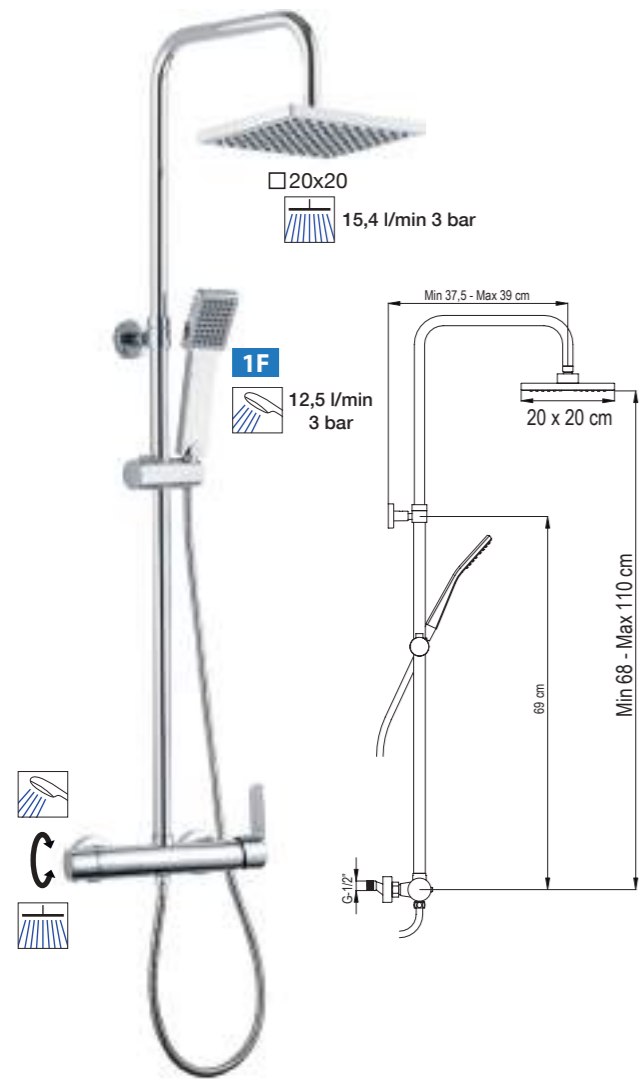

- Monomando con distribuidor incorporado
- Rociador de 20 x 20 cm, en ABS
- Barra extensible de acero inoxidable AISI 304
- Flexo de acero inoxidable doble grapado, antitorsión, 1,70 m

- Single lever mixer with integrated distributor
- ABS shower head, 20 x 20 cm
- Stainless steel AISI 304 extensible bar
- Stainless steel flexible shower hose double hooked, anti-twist, 1,70 m

- Mitigeur avec distributeur intégré
- Douche de tête de 20 x 20 cm, en ABS
- Barre extensible en acier inoxydable AISI 304
- Flexible en acier inoxydable double agrafage, anti-torsion, 1,70 m

- Miscelatore con distributore integrato
- Soffione 20 x 20 cm, in ABS
- Barra allungabile in acciaio inossidabile AISI 304
- Flessibile di doppia aggraffatura in acciaio inossidabile, anti-torsione, 1,70 m

21NOAMD01

OPCIONAL / OPTIONAL / OPTIONNEL / OPZIONALE

Kit 2 reductores caudal 9 l/min ducha/rociador  
 2 flow rate reducer kit 9 l/min hand shower/head shower  
 Kit 2 réducteurs débit 9l/min douchette/douche de tête  
 Kit 2 riduttori portata 9 l/min maniglia doccia/soffione

6024X2



NEW PACIFIC

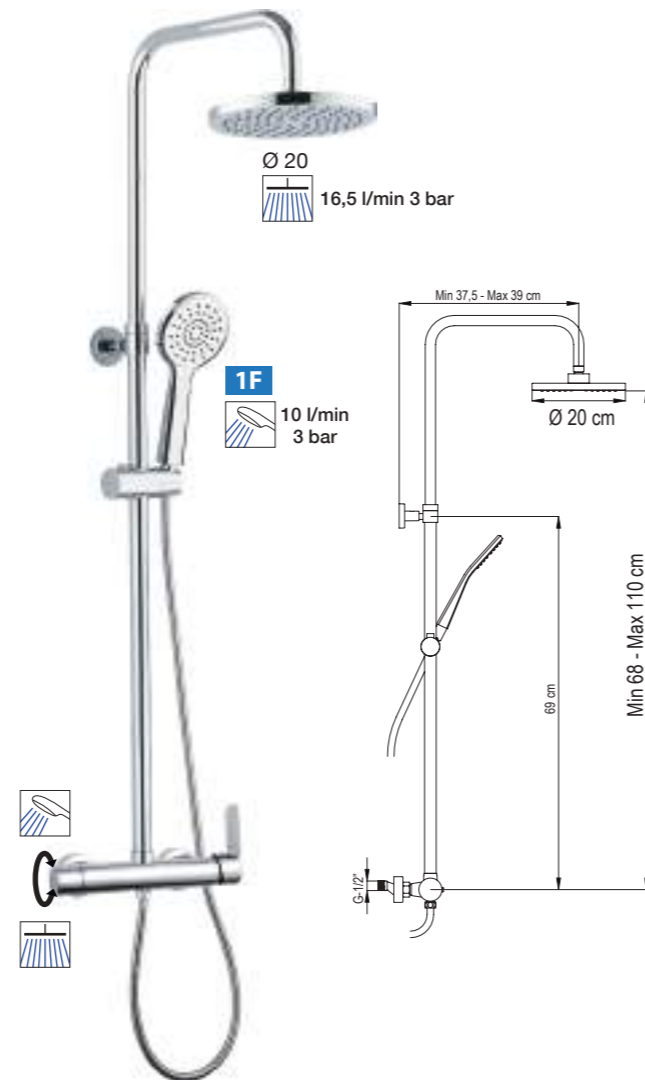

- Monomando con distribuidor incorporado
- Rociador de Ø 20 cm, en ABS
- Barra extensible de acero inoxidable AISI 304
- Flexo de acero inoxidable doble grapado, antitorsión, 1,70 m

- Single lever mixer with integrated distributor
- ABS shower head, Ø 20 cm
- Stainless steel AISI 304 extensible bar
- Stainless steel flexible shower hose double hooked, anti-twist, 1,70 m

- Mitigeur avec distributeur intégré
- Douche de tête de Ø 20 cm, en ABS
- Barre extensible en acier inoxydable AISI 304
- Flexible en acier inoxydable double agrafage, anti-torsion, 1,70 m

- Miscelatore con distributore integrato
- Soffione Ø 20 cm, in ABS
- Barra allungabile in acciaio inossidabile AISI 304
- Flessibile di doppia aggraffatura in acciaio inossidabile, anti-torsione, 1,70 m

21NPAMD01

OPCIONAL / OPTIONAL / OPTIONNEL / OPZIONALE

Kit 2 reductores caudal 9 l/min ducha/rociador  
 2 flow rate reducer kit 9 l/min hand shower/head shower  
 Kit 2 réducteurs débit 9l/min douchette/douche de tête  
 Kit 2 riduttori portata 9 l/min maniglia doccia/soffione

6024X2



Disponibile: Marzo 2022 / Available: March 2022  
 Disponible: Mars 2022 / Disponibile: Marzo 2022

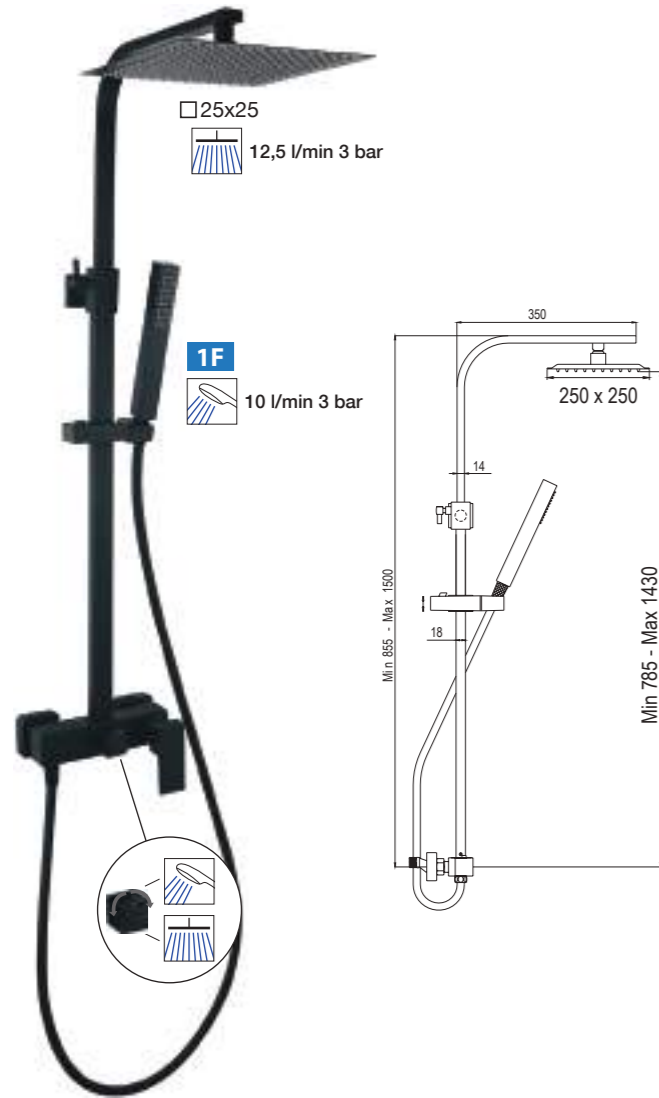

- Monomando con distribuidor incorporado
- Rociador de 25 x 25 cm, de acero inoxidable AISI 304
- Barra extensible de acero inoxidable
- Flexo de PVC, antitorsión, 1,75 m

- Single lever mixer with integrated distributor
- Stainless steel AISI 304 shower head, 25 x 25 cm
- Stainless steel extensible bar
- PVC flexible hose, anti-twist, 1,75 m

- Mitigeur avec distributeur intégré
- Douche de tête de 25 x 25 cm, en acier inoxydable AISI 304
- Barre extensible en acier inoxydable
- Flexible en PVC, anti-torsion, 1,75 m

- Miscelatore con distributore integrato
- Soffione 25 x 25 cm, in acciaio inossidabile AISI 304
- Barra allungabile in acciaio inossidabile
- Flessibile in PVC, anti-torsione, 1,75 m

21QUC25LUD05

OPCIONAL / OPTIONAL / OPTIONNEL / OPZIONALE

Kit 2 reductores caudal 9 l/min ducha/rociador  
 2 flow rate reducer kit 9 l/min hand shower/head shower  
 Kit 2 réducteurs débit 9l/min douchette/douche de tête  
 Kit 2 riduttori portata 9 l/min maniglia doccia/soffione

6024X2





- Monomando con distribuidor incorporado
- Rociador de Ø 25 cm, de acero inoxidable AISI 304
- Barra extensible de acero inoxidable AISI 304
- Flexo de PVC, antitorsión, 1,75 m

- Single lever mixer with integrated distributor
- Stainless steel AISI 304 shower head, Ø 25 cm
- Stainless steel AISI 304 extensible bar
- PVC flexible hose, anti-twist, 1,75 m

- Mitigeur avec distributeur intégré
- Douche de tête de Ø 25 cm, en acier inoxydable AISI 304
- Barre extensible en acier inoxydable AISI 304
- Flexible en PVC, anti-torsion, 1,75 m

- Miscelatore con distributore integrato
- Soffione Ø 25 cm, in acciaio inossidabile AISI 304
- Barra allungabile in acciaio inossidabile AISI 304
- Flessibile in PVC, anti-torsione, 1,75 m

21NITR25BEA05

OPCIONAL / OPTIONAL / OPTIONNEL / OPZIONALE

**Reductor caudal 9 l/min ducha/rociador**  
 Flow rate reducer 9 l/min hand shower/shower head  
 Réducteur débit 9 l/min douchette/douche de tête  
 Riduttore portata da 9 l/min maniglia doccia/soffione

6024 
 9 l/min 3 bar



- Monomando con distribuidor incorporado
- Rociador de 25 x 25 cm, de acero inoxidable AISI 304
- Barra extensible de acero inoxidable AISI 304
- Flexo de PVC, antitorsión, 1,75 m

- Single lever mixer with integrated distributor
- Stainless steel AISI 304 shower head, 25 x 25 cm
- Stainless steel AISI 304 extensible bar
- PVC flexible hose, anti-twist, 1,75 m

- Mitigeur avec distributeur intégré
- Douche de tête de 25 x 25 cm, en acier inoxydable AISI 304
- Barre extensible en acier inoxydable AISI 304
- Flexible en PVC, anti-torsion, 1,75 m

- Miscelatore con distributore integrato
- Soffione 25 x 25 cm, in acciaio inossidabile AISI 304
- Barra allungabile in acciaio inossidabile AISI 304
- Flessibile in PVC, anti-torsione, 1,75 m

21NITC25ALA05

OPCIONAL / OPTIONAL / OPTIONNEL / OPZIONALE

**Reductor caudal 9 l/min ducha/rociador**  
 Flow rate reducer 9 l/min hand shower/shower head  
 Réducteur débit 9 l/min douchette/douche de tête  
 Riduttore portata da 9 l/min maniglia doccia/soffione

6024



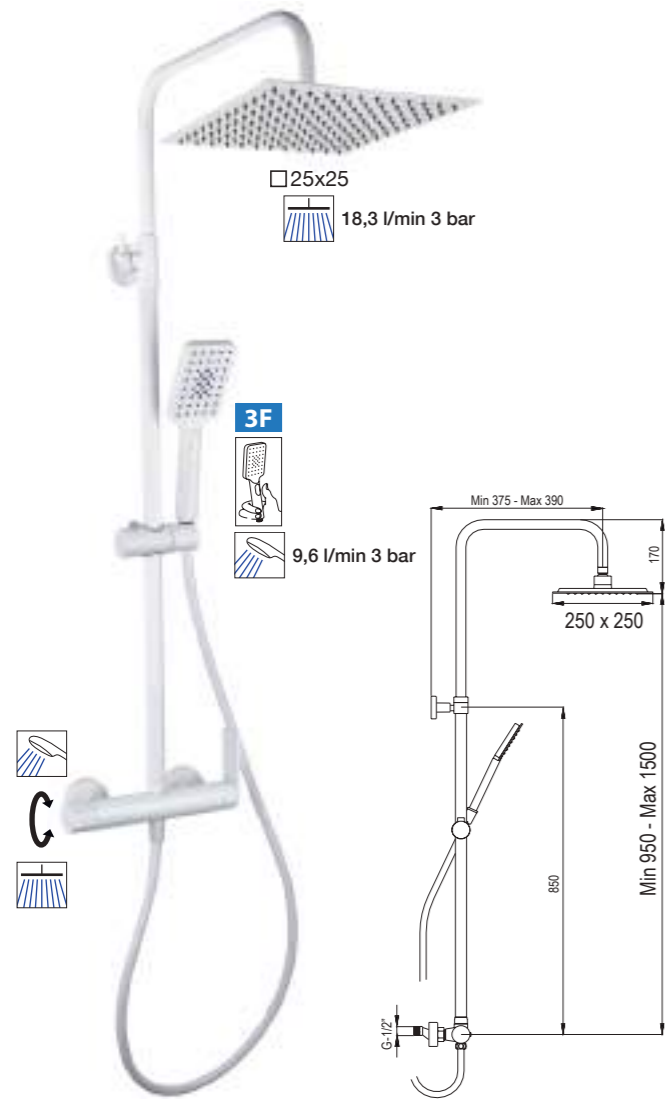

- Monomando con distribuidor incorporado
- Rociador de 25 x 25 cm, de acero inoxidable AISI 304
- Barra extensible de acero inoxidable AISI 304
- Flexo de PVC, antitorsión, 1,75 m

- Single lever mixer with integrated distributor
- Stainless steel AISI 304 shower head, 25 x 25 cm
- Stainless steel AISI 304 extensible bar
- PVC flexible hose, anti-twist, 1,75 m

- Mitigeur avec distributeur intégré
- Douche de tête de 25 x 25 cm, en acier inoxydable AISI 304
- Barre extensible en acier inoxydable AISI 304
- Flexible en PVC, anti-torsion, 1,75 m

- Miscelatore con distributore integrato
- Soffione 25 x 25 cm, in acciaio inossidabile AISI 304
- Barra allungabile in acciaio inossidabile AISI 304
- Flessibile in PVC, anti-torsione, 1,75 m

21NITC25ALA03

OPCIONAL / OPTIONAL / OPTIONNEL / OPZIONALE

**Reductor caudal 9 l/min ducha/rociador**  
 Flow rate reducer 9 l/min hand shower/shower head  
 Réducteur débit 9 l/min douchette/douche de tête  
 Riduttore portata da 9 l/min maniglia doccia/soffione

6024 

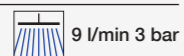



Disponible: Mayo 2022 / Available: May 2022  
 Disponible: Mai 2022 / Disponibile: Maggio 2022



**OPCIONES DE ROCIADOR**  
**SHOWER HEAD OPTIONS**  
**OPTIONS POUR DOUCHE DE TÊTE**  
**OPZIONI PER SOFFIONE**



20 x 20 cm

Con rociador Atlas C20, de acero inoxidable AISI 304, ultrafino, 20 x 20 cm  
 With Atlas C20 shower head, in stainless steel AISI 304, ultraslim, 20 x 20 cm  
 Avec douche de tête Atlas C20, en acier inoxydable AISI 304, ultrafine, 20 x 20 cm  
 Con soffione Atlas C20, in acciaio inossidabile AISI 304, ultrasottile, 20 x 20 cm

21BLC20BLB02



25 x 25 cm

Con rociador Atlas C25, de acero inoxidable AISI 304, ultrafino, 25 x 25 cm  
 With Atlas C25 shower head, in stainless steel AISI 304, ultraslim, 25 x 25 cm  
 Avec douche de tête Atlas C25, en acier inoxydable AISI 304, ultrafine, 25 x 25 cm  
 Con soffione Atlas C25, in acciaio inossidabile AISI 304, ultrasottile, 25 x 25 cm

21BLC25BLB02

- Monomando con distribuidor incorporado
- Con caño de bañera abatible (el agua se acciona al desplegar el caño)
- Barra extensible de acero inoxidable
- Flexo de acero inoxidable doble grapado, antitorsión, 1,70 m

- Single lever mixer with integrated distributor
- With foldable bath spout (water flows when folding the spout)
- Stainless steel extensible bar
- Stainless steel flexible hose double hooked, anti-twist, 1,70 m

- Mitigeur avec distributeur intégré
- Avec bec de baignoire rabattable (l'eau est actionnée en déployant le bec)
- Barre extensible en acier inoxydable
- Flexible en acier inoxydable double agrafage, anti-torsion, 1,70 m

- Miscelatore con distributore integrato
- Con bocca vasca ribaltabile (l'acqua si attiva girando la bocca)
- Barra allungabile in acciaio inossidabile
- Flessibile di doppia aggraffatura in acciaio inossidabile, anti-torsione, 1,70 m

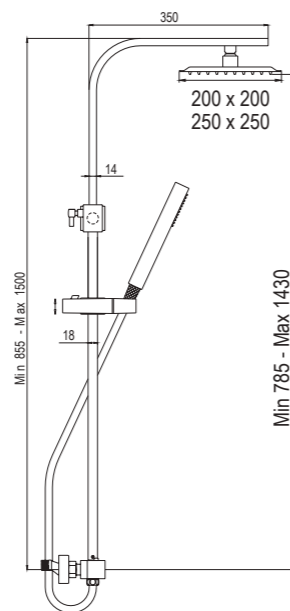

WIND BLU RD

WIND BLU SQ



3F

OPCIONES DE ROCIADOR  
 SHOWER HEAD OPTIONS  
 OPTIONS POUR DOUCHE DE TÊTE  
 OPZIONI PER SOFFIONE

**Wind Blu RD**  
 en ABS  
 in ABS  
 en ABS  
 in ABS  
 Ø 24 cm  
 21WBR24SUB01

**Atlas R20**  
 en AISI 304  
 in AISI 304  
 en AISI 304  
 in AISI 304  
 Ø 20 cm  
 21WBR20SUB02

**Atlas R25**  
 en AISI 304  
 in AISI 304  
 en AISI 304  
 in AISI 304  
 Ø 25 cm  
 21WBR25SUB02



1F

OPCIONES DE ROCIADOR  
 SHOWER HEAD OPTIONS  
 OPTIONS POUR DOUCHE DE TÊTE  
 OPZIONI PER SOFFIONE

**Wind Blu SQ**  
 en ABS  
 in ABS  
 en ABS  
 in ABS  
 22,5 x 22,5 cm  
 21WBC22SUB01

**Atlas C20**  
 en AISI 304  
 in AISI 304  
 en AISI 304  
 in AISI 304  
 20 x 20 cm  
 21WBC20SUB02

**Atlas C25**  
 en AISI 304  
 in AISI 304  
 en AISI 304  
 in AISI 304  
 25 x 25 cm  
 21WBC25SUB02

- Monomando con distribuidor incorporado
- Con caño de bañera abatible (el agua se acciona al desplegar el caño)
- Barra extensible de acero inoxidable AISI 304
- Flexo de acero inoxidable doble grapado, antitorsión, 1,70 m

- Single lever mixer with integrated distributor
- With foldable bath spout (water flows when folding the spout)
- Stainless steel AISI 304 extensible bar
- Stainless steel flexible hose double hooked, anti-twist, 1,70 m

- Mitigeur avec distributeur intégré
- Avec bec de baignoire rabattable (l'eau est actionnée en déployant le bec)
- Barre extensible en acier inoxydable AISI 304
- Flexible en acier inoxydable double agrafage, anti-torsion, 1,70 m

- Miscelatore con distributore integrato
- Con bocca vasca ribaltabile (l'acqua si attiva girando la bocca)
- Barra allungabile in acciaio inossidabile AISI 304
- Flessibile di doppia aggraffatura in acciaio inossidabile, anti-torsione, 1,70 m

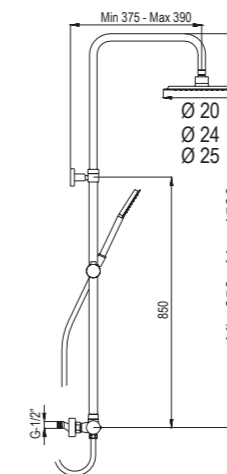

- Monomando con distribuidor incorporado
- Con caño de bañera abatible (el agua se acciona al desplegar el caño)
- Barra extensible de acero inoxidable AISI 304
- Flexo de acero inoxidable doble grapado, antitorsión, 1,70 m

- Single lever mixer with integrated distributor
- With foldable bath spout (water flows when folding the spout)
- Stainless steel AISI 304 extensible bar
- Stainless steel flexible hose double hooked, anti-twist, 1,70 m

- Mitigeur avec distributeur intégré
- Avec bec de baignoire rabattable (l'eau est actionnée en déployant le bec)
- Barre extensible en acier inoxydable AISI 304
- Flexible en acier inoxydable double agrafage, anti-torsion, 1,70 m

- Miscelatore con distributore integrato
- Con bocca vasca ribaltabile (l'acqua si attiva girando la bocca)
- Barra allungabile in acciaio inossidabile AISI 304
- Flessibile di doppia aggraffatura in acciaio inossidabile, anti-torsione, 1,70 m

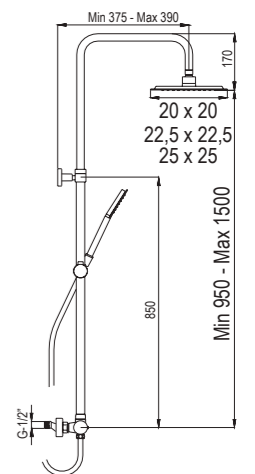

NITE

NEW

Disponibile: Marzo 2022 / Available: March 2022  
 Disponible: Mars 2022 / Disponibile: Marzo 2022



21NITC25SUB05

21NITR25SUB05

- Monomando con distribuidor incorporado
- Con caño de bañera abatible (el agua se acciona al desplegar el caño)
- Barra extensible de acero inoxidable AISI 304
- Flexo de PVC, antitorsión, 1,75 m

- Single lever mixer with integrated distributor
- With foldable bath spout (water flows when folding the spout)
- Stainless steel AISI 304 extensible bar
- PVC flexible hose, anti-twist, 1,75 m

- Mitigeur avec distributeur intégré
- Avec bec de baignoire rabattable (l'eau est actionnée en déployant le bec)
- Barre extensible en acier inoxydable AISI 304
- Flexible en PVC, anti-torsion, 1,75 m

- Miscelatore con distributore integrato
- Con bocca vasca ribaltabile (l'acqua si attiva girando la bocca)
- Barra allungabile in acciaio inossidabile AISI 304
- Flessibile in PVC, anti-torsione, 1,75 m

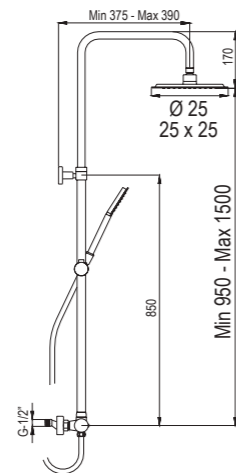

LUXOR



**OPCIONES DE ROCIADOR**  
**SHOWER HEAD OPTIONS**  
**OPTIONS POUR DOUCHE DE TÊTE**  
**OPZIONI PER SOFFIONE**



20 x 20 cm

Con rociador Atlas C20, de acero inoxidable AISI 304, ultrafino, 20 x 20 cm  
 With Atlas C20 shower head, in stainless steel AISI 304, ultraslim, 20 x 20 cm  
 Avec douche de tête Atlas C20, en acier inoxydable AISI 304, ultrafine, 20 x 20 cm  
 Con soffione Atlas C20, in acciaio inossidabile AISI 304, ultrasottile, 20 x 20 cm



12,5 l/min 3 bar

20LUC20LUD02



25 x 25 cm

Con rociador Atlas C25, de acero inoxidable AISI 304, ultrafino, 25 x 25 cm  
 With Atlas C25 shower head, in stainless steel AISI 304, ultraslim, 25 x 25 cm  
 Avec douche de tête Atlas C25, en acier inoxydable AISI 304, ultrafine, 25 x 25 cm  
 Con soffione Atlas C25, in acciaio inossidabile AISI 304, ultrasottile, 25 x 25 cm



12,5 l/min 3 bar

20LUC25LUD02

**OPCIONAL / OPTIONAL / OPTIONNEL / OPZIONALE**

**Kit 2 reductores caudal 9 l/min ducha/rociador**  
**2 flow rate reducer kit 9 l/min hand shower/head shower**  
**Kit 2 réducteurs débit 9l/min douchette/douche de tête**  
**Kit 2 riduttori portata 9 l/min maniglia doccia/soffione**

6024X2



9 l/min 3 bar



9 l/min 3 bar

- Termostática con distribuidor incorporado
- Barra extensible de acero inoxidable
- Flexo de acero inoxidable doble grapado, antitorsión, 1,70 m
- Thermostatic mixer with integrated distributor
- Stainless steel extensible bar
- Stainless steel flexible hose double hooked, anti-torsion, 1,70 m
- Thermostatique avec distributeur intégré
- Barre extensible en acier inoxydable
- Flexible en acier inoxydable double agrafage, anti-torsion, 1,70 m
- Termostatico con distributore integrato
- Barra allungabile in acciaio inossidabile
- Flessibile di doppia aggraffatura in acciaio inossidabile, anti-torsione, 1,70 m

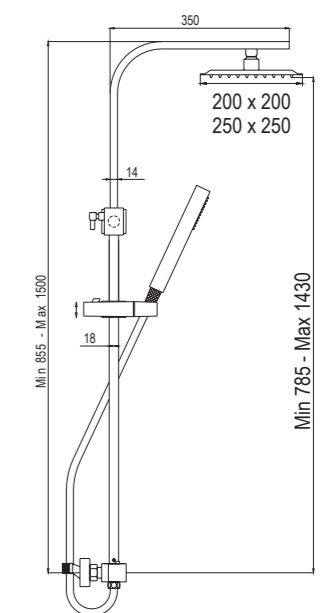

BERENICE

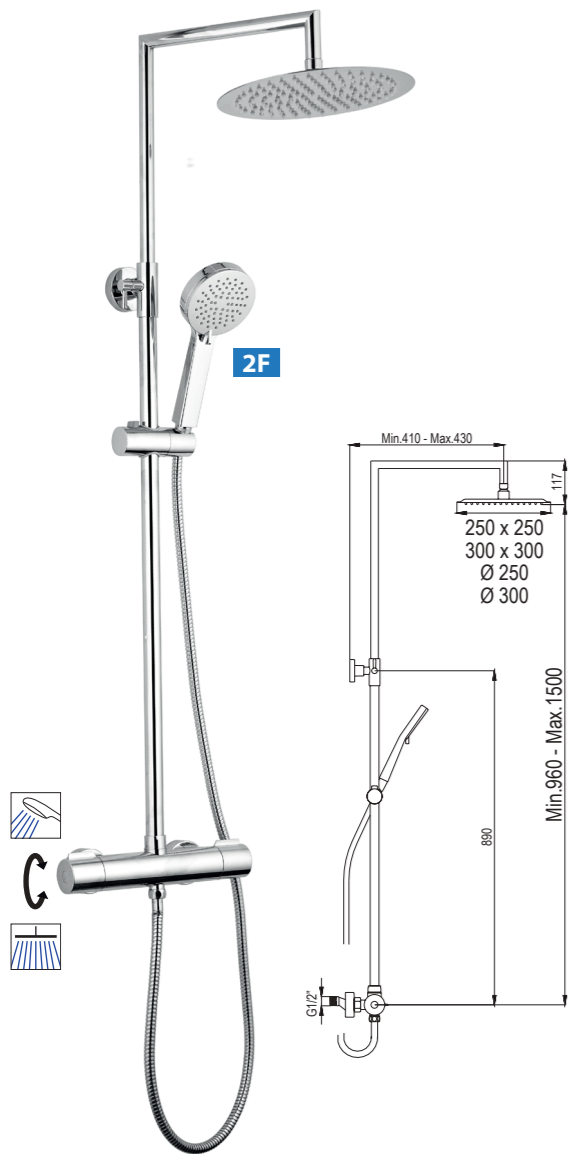

OPCIONES DE ROCIADOR  
 SHOWER HEAD OPTIONS  
 OPTIONS POUR DOUCHE DE TÊTE  
 OPZIONI PER SOFFIONE



Ø 25 cm

Con rociador Atlas R25, de acero inoxidable AISI 304, ultrafino, Ø 25 cm  
 With Atlas R25 shower head, in stainless steel AISI 304, ultraslim, Ø 25 cm  
 Avec douche de tête Atlas R25, en acier inoxydable AISI 304, ultrafine, Ø 25 cm  
 Con soffione Atlas R25, in acciaio inossidabile AISI 304, ultrasottile, Ø 25 cm

20BER25SID02



Ø 30 cm

Con rociador Atlas R30, de acero inoxidable AISI 304, ultrafino, Ø 30 cm  
 With Atlas R30 shower head, in stainless steel AISI 304, ultraslim, Ø 30 cm  
 Avec douche de tête Atlas R30, en acier inoxydable AISI 304, ultrafine, Ø 30 cm  
 Con soffione Atlas R30, in acciaio inossidabile AISI 304, ultrasottile, Ø 30 cm

20BER30SID02



25 x 25 cm

Con rociador Atlas C25, de acero inoxidable AISI 304, ultrafino, 25 x 25 cm  
 With Atlas C25 shower head, in stainless steel AISI 304, ultraslim, 25 x 25 cm  
 Avec douche de tête Atlas C25, en acier inoxydable AISI 304, ultrafine, 25 x 25 cm  
 Con soffione Atlas C25, in acciaio inossidabile AISI 304, ultrasottile, 25 x 25 cm

20BEC25SID02



30 x 30 cm

Con rociador Atlas C30, de acero inoxidable AISI 304, ultrafino, 30 x 30 cm  
 With Atlas C30 shower head, in stainless steel AISI 304, ultraslim, 30 x 30 cm  
 Avec douche de tête Atlas C30, en acier inoxydable AISI 304, ultrafine, 30 x 30 cm  
 Con soffione Atlas C30, in acciaio inossidabile AISI 304, ultrasottile, 30 x 30 cm

20BEC30SID02

- Termostática con distribuidor incorporado
- Barra extensible de acero inoxidable AISI 304
- Flexo de acero inoxidable doble grapado, antitorsión, 1,70 m

- Thermostatic mixer with integrated distributor
- Stainless steel AISI 304 extensible bar
- Stainless steel flexible hose double hooked, anti-twist, 1,70 m

- Thermostatique avec distributeur intégré
- Barre extensible en acier inoxydable AISI 304
- Flexible en acier inoxydable double agrafage, anti-torsion, 1,70 m

- Termostatico con distributore integrato
- Barra allungabile in acciaio inossidabile AISI 304
- Flessibile di doppia aggraffatura in acciaio inossidabile, anti-torsione, 1,70 m





- Cartucho termostático Citec
- Termostática con distribuidor incorporado
- Rociador de 25 x 25 cm, de acero inoxidable AISI 304
- Barra extensible de acero inoxidable AISI 304
- Flexo de acero inoxidable doble grapado, antitorsión, 1,70 m

- Citec thermostatic cartridge
- Thermostatic mixer with integrated distributor
- Stainless steel AISI 304 shower head, 25 x 25 cm
- Stainless steel AISI 304 extensible bar
- Stainless steel flexible hose double hooked, anti-twist, 1,70 m

- Cartouche thermostatique Citec
- Thermostatique avec distributeur intégré
- Douche de tête de 25 x 25 cm, en acier inoxydable AISI 304
- Barre extensible en acier inoxydable AISI 304
- Flexible en acier inoxydable double agrafage, anti-torsion, 1,70 m

- Cartuccia termostatica Citec
- Termostatico con distributore integrato
- Soffione 25 x 25 cm, in acciaio inossidabile AISI 304
- Barra allungabile in acciaio inossidabile AISI 304
- Flessibile di doppia aggraffatura in acciaio inossidabile, anti-torsione, 1,70 m

20NITC25ESD02

OPCIONAL / OPTIONAL / OPTIONNEL / OPZIONALE

**Reductor caudal 9 l/min ducha/rociador**  
Flow rate reducer 9 l/min hand shower/shower head  
Réducteur débit 9 l/min douchette/douche de tête  
Riduttore portata da 9 l/min maniglia doccia/soffione

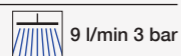
6024 

9 l/min 3 bar

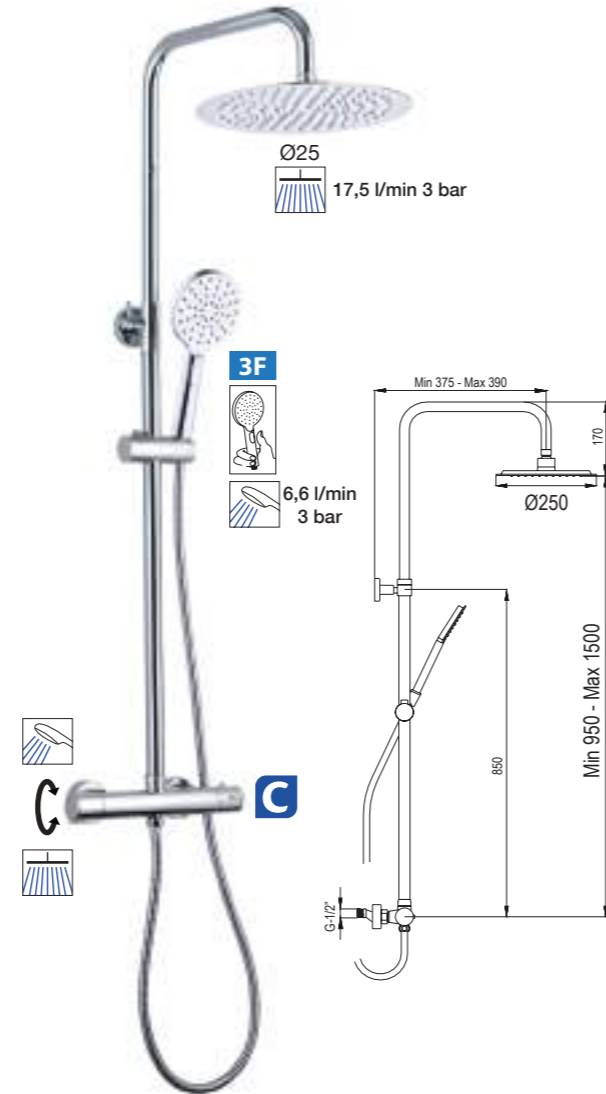

- Cartucho termostático Citec
- Termostática con distribuidor incorporado
- Rociador de Ø 25 cm, de acero inoxidable AISI 304
- Barra extensible de acero inoxidable AISI 304
- Flexo de acero inoxidable doble grapado, antitorsión, 1,70 m

- Citec thermostatic cartridge
- Thermostatic mixer with integrated distributor
- Stainless steel AISI 304 shower head, Ø 25 cm
- Stainless steel AISI 304 extensible bar
- Stainless steel flexible hose double hooked, anti-twist, 1,70 m

- Cartouche thermostatique Citec
- Thermostatique avec distributeur intégré
- Douche de tête de Ø 25 cm, en acier inoxydable AISI 304
- Barre extensible en acier inoxydable AISI 304
- Flexible en acier inoxydable double agrafage, anti-torsion, 1,70 m

- Cartuccia termostatica Citec
- Termostatico con distributore integrato
- Soffione Ø 25 cm, in acciaio inossidabile AISI 304
- Barra allungabile in acciaio inossidabile AISI 304
- Flessibile di doppia aggraffatura in acciaio inossidabile, anti-torsione, 1,70 m

20NITR25ESD02

OPCIONAL / OPTIONAL / OPTIONNEL / OPZIONALE

**Reductor caudal 9 l/min ducha/rociador**  
Flow rate reducer 9 l/min hand shower/shower head  
Réducteur débit 9 l/min douchette/douche de tête  
Riduttore portata da 9 l/min maniglia doccia/soffione

6024 

9 l/min 3 bar



WIND BLU RD



OPCIONES DE ROCIADOR  
SHOWER HEAD OPTIONS  
OPTIONS POUR DOUCHE DE TÊTE  
OPZIONI PER SOFFIONE



Ø 24 cm



16,6 l/min 3 bar

Con rociador Wind Blu RD, de ABS, Ø 24 cm  
With Wind Blu RD shower head, in ABS, Ø 24 cm  
Avec douche de tête Wind Blu RD, en ABS, Ø 24 cm  
Con soffione Wind Blu RD, in ABS, Ø 24 cm

20WBR24ESD01



Ø 20 cm



17,5 l/min 3 bar

Con rociador Atlas R20, de acero inoxidable AISI 304, ultrafino, Ø 20 cm  
With Atlas R20 shower head, in stainless steel AISI 304, ultraslim, Ø 20 cm  
Avec douche de tête Atlas R20, en acier inoxydable AISI 304, ultrafine, Ø 20 cm  
Con soffione Atlas R20, in acciaio inossidabile AISI 304, ultrasottile, Ø 20 cm

20WBR20ESD02



Ø 25 cm



17,5 l/min 3 bar

Con rociador Atlas R25, de acero inoxidable AISI 304, ultrafino, Ø 25 cm  
With Atlas R25 shower head, in stainless steel AISI 304, ultraslim, Ø 25 cm  
Avec douche de tête Atlas R25, en acier inoxydable AISI 304, ultrafine, Ø 25 cm  
Con soffione Atlas R25, in acciaio inossidabile AISI 304, ultrasottile, Ø 25 cm

20WBR25ESD02

OPCIONAL / OPTIONAL / OPTIONNEL / OPZIONALE

Kit 2 reductores caudal 9 l/min ducha/rociador  
2 flow rate reducer kit 9 l/min hand shower/head shower  
Kit 2 réducteurs débit 9l/min douchette/douche de tête  
Kit 2 riduttori portata 9 l/min maniglia doccia/soffione

6024X2



9 l/min 3 bar



9 l/min 3 bar

- Cartucho termostático Citec
- Termostática con distribuidor incorporado
- Barra extensible de acero inoxidable AISI 304
- Flexo de acero inoxidable doble grapado, antitorsión, 1,70 m

- Citec thermostatic cartridge
- Thermostatic mixer with integrated distributor
- Stainless steel AISI 304 extensible bar
- Stainless steel flexible hose double hooked, anti-twist, 1,70 m

- Cartouche thermostatique Citec
- Thermostatique avec distributeur intégré
- Barre extensible en acier inoxydable AISI 304
- Flexible en acier inoxydable double agrafage, anti-torsion, 1,70 m

- Cartuccia termostatica Citec
- Termostatico con distributore integrato
- Barra allungabile in acciaio inossidabile AISI 304
- Flessibile di doppia aggraffatura in acciaio inossidabile, anti-torsione, 1,70 m

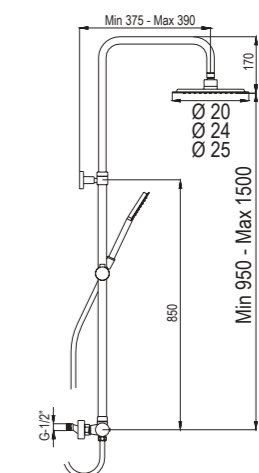

WIND BLU SQ



OPCIONES DE ROCIADOR  
 SHOWER HEAD OPTIONS  
 OPTIONS POUR DOUCHE DE TÊTE  
 OPZIONI PER SOFFIONE



22,5 x 22,5 cm

Con rociador Wind Blu SQ, de ABS, 22,5 x 22,5 cm  
 With Wind Blu SQ shower head, in ABS, 22,5 x 22,5 cm  
 Avec douche de tête Wind Blu SQ, en ABS, 22,5 x 22,5 cm  
 Con soffione Wind Blu SQ, in ABS, 22,5 x 22,5 cm



18,3 l/min 3 bar

20WBC22ESD01



20 x 20 cm

Con rociador Atlas C20, de acero inoxidable AISI 304, ultrafino, 20 x 20 cm  
 With Atlas C20 shower head, in stainless steel AISI 304, ultraslim, 20 x 20 cm  
 Avec douche de tête Atlas C20, en acier inoxydable AISI 304, ultrafine, 20 x 20 cm  
 Con soffione Atlas C20, in acciaio inossidabile AISI 304, ultrasottile, 20 x 20 cm

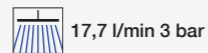

17,7 l/min 3 bar

20WBC20ESD02



25 x 25 cm

Con rociador Atlas C25, de acero inoxidable AISI 304, ultrafino, 25 x 25 cm  
 With Atlas C25 shower head, in stainless steel AISI 304, ultraslim, 25 x 25 cm  
 Avec douche de tête Atlas C25, en acier inoxydable AISI 304, ultrafine, 25 x 25 cm  
 Con soffione Atlas C25, in acciaio inossidabile AISI 304, ultrasottile, 25 x 25 cm

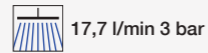

17,7 l/min 3 bar

20WBC25ESD02

OPCIONAL / OPTIONAL / OPTIONNEL / OPZIONALE

Kit 2 reductores caudal 9 l/min ducha/rociador  
 2 flow rate reducer kit 9 l/min hand shower/head shower  
 Kit 2 réducteurs débit 9l/min douchette/douche de tête  
 Kit 2 riduttori portata 9 l/min maniglia doccia/soffione

6024X2



9 l/min 3 bar



9 l/min 3 bar

- Cartucho termostático Citec
- Termostática con distribuidor incorporado
- Barra extensible de acero inoxidable AISI 304
- Flexo de acero inoxidable doble grapado, antitorsión, 1,70 m

- Citec thermostatic cartridge
- Thermostatic mixer with integrated distributor
- Stainless steel AISI 304 extensible bar
- Stainless steel flexible hose double hooked, anti-twist, 1,70 m

- Cartouche thermostatique Citec
- Thermostatique avec distributeur intégré
- Barre extensible en acier inoxydable AISI 304
- Flexible en acier inoxydable double agrafage, anti-torsion, 1,70 m

- Cartuccia termostatica Citec
- Termostatico con distributore integrato
- Barra allungabile in acciaio inossidabile AISI 304
- Flessibile di doppia aggraffatura in acciaio inossidabile, anti-torsione, 1,70 m

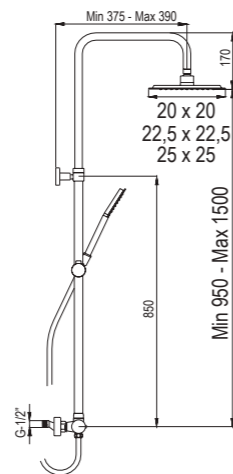



NEW OCEAN

NEW PACIFIC

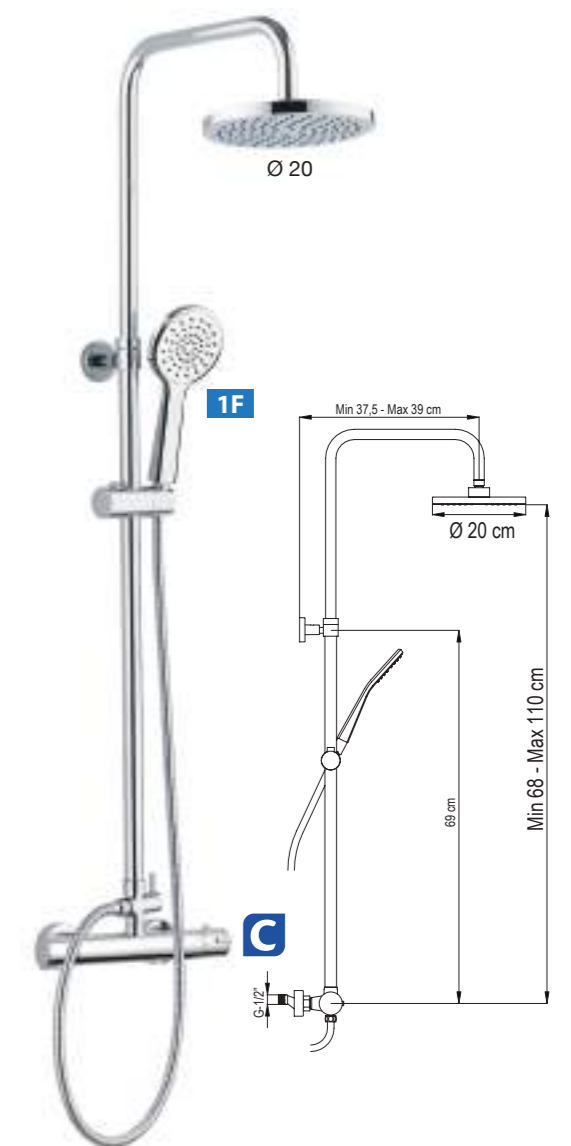

- Cartucho termostático Citec
- Rociador de 20 x 20 cm, de acero inoxidable AISI 304
- Barra extensible de acero inoxidable AISI 304
- Flexo de acero inoxidable doble grapado, antitorsión, 1,70 m
- Citec thermostatic cartridge
- Stainless steel AISI 304 shower head, 20 x 20 cm
- Stainless steel AISI 304 extensible bar
- Stainless steel flexible shower hose double hooked, anti-twist, 1,70 m
- Cartouche thermostatique Citec
- Douche de tête de 20 x 20 cm, en acier inoxydable AISI 304
- Barre extensible en acier inoxydable AISI 304
- Flexible en acier inoxydable double agrafage, anti-torsion, 1,70 m
- Cartuccia termostatica Citec
- Soffione 20 x 20 cm, in acciaio inossidabile AISI 304
- Barra allungabile in acciaio inossidabile AISI 304
- Flessibile di doppia aggraffatura in acciaio inossidabile, anti-torsione, 1,70 m

- Cartucho termostático Citec
- Rociador de Ø 20 cm, de acero inoxidable AISI 304
- Barra extensible de acero inoxidable AISI 304
- Flexo de acero inoxidable doble grapado, antitorsión, 1,70 m
- Citec thermostatic cartridge
- Stainless steel AISI 304 shower head, Ø 20 cm
- Stainless steel AISI 304 extensible bar
- Stainless steel flexible shower hose double hooked, anti-twist, 1,70 m
- Cartouche thermostatique Citec
- Douche de tête de Ø 20 cm, en acier inoxydable AISI 304
- Barre extensible en acier inoxydable AISI 304
- Flexible en acier inoxydable double agrafage, anti-torsion, 1,70 m
- Cartuccia termostatica Citec
- Soffione Ø 20 cm, in acciaio inossidabile AISI 304
- Barra allungabile in acciaio inossidabile AISI 304
- Flessibile di doppia aggraffatura in acciaio inossidabile, anti-torsione, 1,70 m

20NOQUD01

20NPOLD01



QUS

NEW

Disponibile: Marzo 2022 / Available: March 2022  
 Disponible: Mars 2022 / Disponibile: Marzo 2022

SISTEMAS DE DUCHA  
 SHOWER SYSTEMS

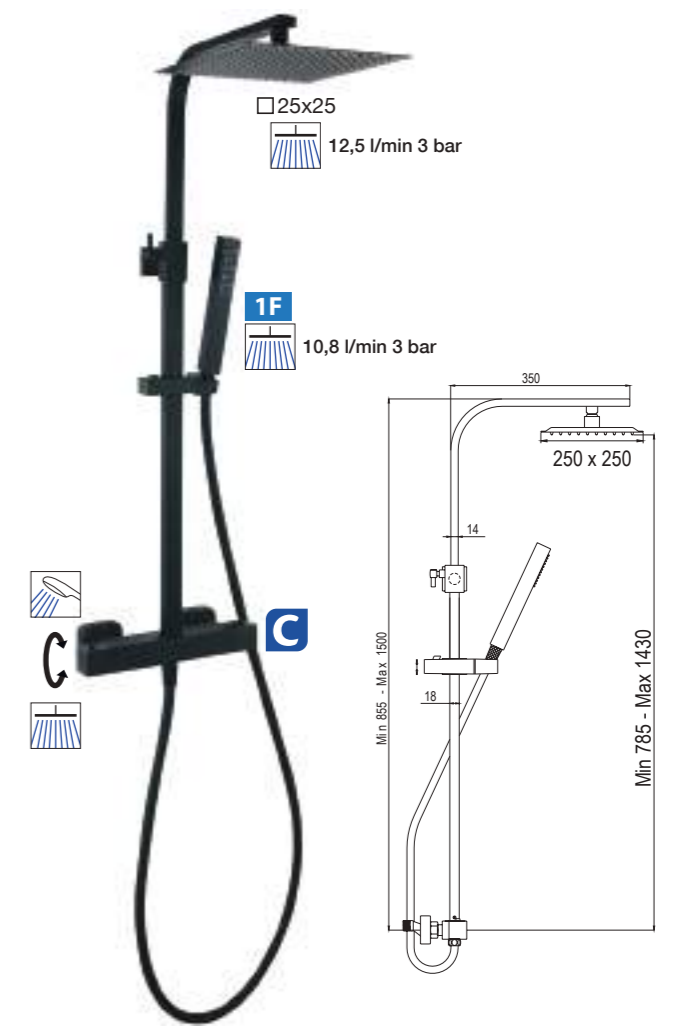

- Cartucho termostático Citec
- Termostática con distribuidor incorporado
- Rociador de 25 x 25 cm, de acero inoxidable AISI 304
- Barra extensible de acero inoxidable
- Flexo de PVC, antitorsión, 1,75 m

- Citec thermostatic cartridge
- Thermostatic mixer with integrated distributor
- Stainless steel AISI 304 shower head, 25 x 25 cm
- Stainless steel extensible bar
- PVC flexible hose, anti-twist, 1,75 m

- Cartouche thermostatique Citec
- Thermostatique avec distributeur intégré
- Douche de tête de 25 x 25 cm, en acier inoxydable AISI 304
- Barre extensible en acier inoxydable
- Flexible en PVC, anti-torsion, 1,75 m

- Cartuccia termostatica Citec
- Termostatico con distributore integrato
- Soffione 25 x 25 cm, in acciaio inossidabile AISI 304
- Barra allungabile in acciaio inossidabile
- Flessibile in PVC, anti-torsione, 1,75 m

20QUC25QUD05

OPCIONAL / OPTIONAL / OPTIONNEL / OPZIONALE

**Kit 2 reductores caudal 9 l/min ducha/rociador**  
 2 flow rate reducer kit 9 l/min hand shower/head shower  
 Kit 2 réducteurs débit 9l/min douchette/douche de tête  
 Kit 2 riduttori portata 9 l/min maniglia doccia/soffione

6024X2

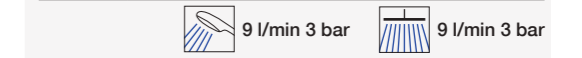

**NITE**



- Termostática con distribuidor incorporado
- Rociador de 25 x 25 cm, de acero inoxidable AISI 304
- Barra extensible de acero inoxidable AISI 304
- Flexo de PVC, antitorsión, 1,75 m

- Thermostatic mixer with integrated distributor
- Stainless steel AISI 304 shower head, 25 x 25 cm
- Stainless steel AISI 304 extensible bar
- PVC flexible hose, anti-twist, 1,75 m

- Thermostatique avec distributeur intégré
- Douche de tête de 25 x 25 cm, en acier inoxydable AISI 304
- Barre extensible en acier inoxydable AISI 304
- Flexible en PVC, anti-torsion, 1,75 m

- Termostatico con distributore integrato
- Soffione 25 x 25 cm, in acciaio inossidabile AISI 304
- Barra allungabile in acciaio inossidabile AISI 304
- Flessibile in PVC, anti-torsione, 1,75 m

20NITR25NID05

**OPCIONAL / OPTIONAL / OPTIONNEL / OPZIONALE**

**Reductor caudal 9 l/min ducha/rociador**  
**Flow rate reducer 9 l/min hand shower/shower head**  
**Réducteur débit 9 l/min douchette/douche de tête**  
**Riduttore portata da 9 l/min maniglia doccia/soffione**

6024 

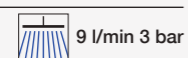

**SISTEMAS DE DUCHA TERMOSTÁTICOS**  
**THERMOSTATIC SHOWER SYSTEMS**  
**SYSTÈMES DE DOUCHE THERMOSTATIQUES**  
**SISTEMI DI DOCCIA TERMOSTATICI**

**NITE**

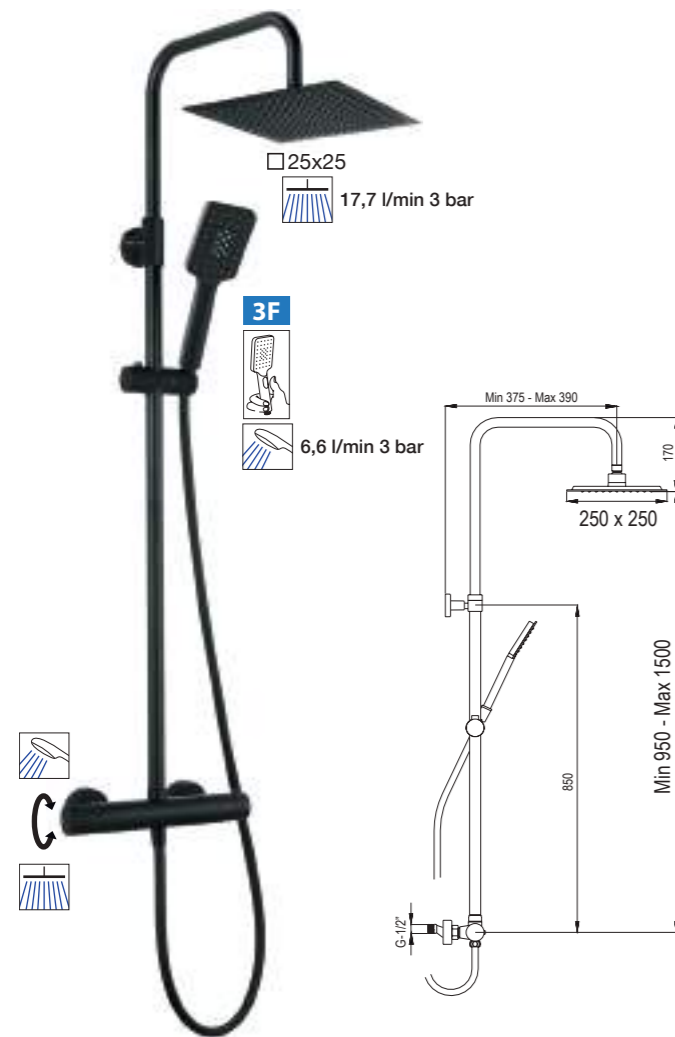

- Termostática con distribuidor incorporado
- Rociador de 25 x 25 cm, de acero inoxidable AISI 304
- Barra extensible de acero inoxidable AISI 304
- Flexo de PVC, antitorsión, 1,75 m

- Thermostatic mixer with integrated distributor
- Stainless steel AISI 304 shower head, 25 x 25 cm
- Stainless steel AISI 304 extensible bar
- PVC flexible hose, anti-twist, 1,75 m

- Thermostatique avec distributeur intégré
- Douche de tête de 25 x 25 cm, en acier inoxydable AISI 304
- Barre extensible en acier inoxydable AISI 304
- Flexible en PVC, anti-torsion, 1,75 m

- Termostatico con distributore integrato
- Soffione 25 x 25 cm, in acciaio inossidabile AISI 304
- Barra allungabile in acciaio inossidabile AISI 304
- Flessibile in PVC, anti-torsione, 1,75 m

20NITC25NID05

**OPCIONAL / OPTIONAL / OPTIONNEL / OPZIONALE**

**Reductor caudal 9 l/min ducha/rociador**  
**Flow rate reducer 9 l/min hand shower/shower head**  
**Réducteur débit 9 l/min douchette/douche de tête**  
**Riduttore portata da 9 l/min maniglia doccia/soffione**

6024 



**SISTEMAS DE DUCHA TERMOSTÁTICOS**  
**THERMOSTATIC SHOWER SYSTEMS**  
**SYSTÈMES DE DOUCHE THERMOSTATIQUES**  
**SISTEMI DI DOCCIA TERMOSTATICI**

**NITE**

**NEW**

SISTEMAS DE DUCHA  
 SHOWER SYSTEMS

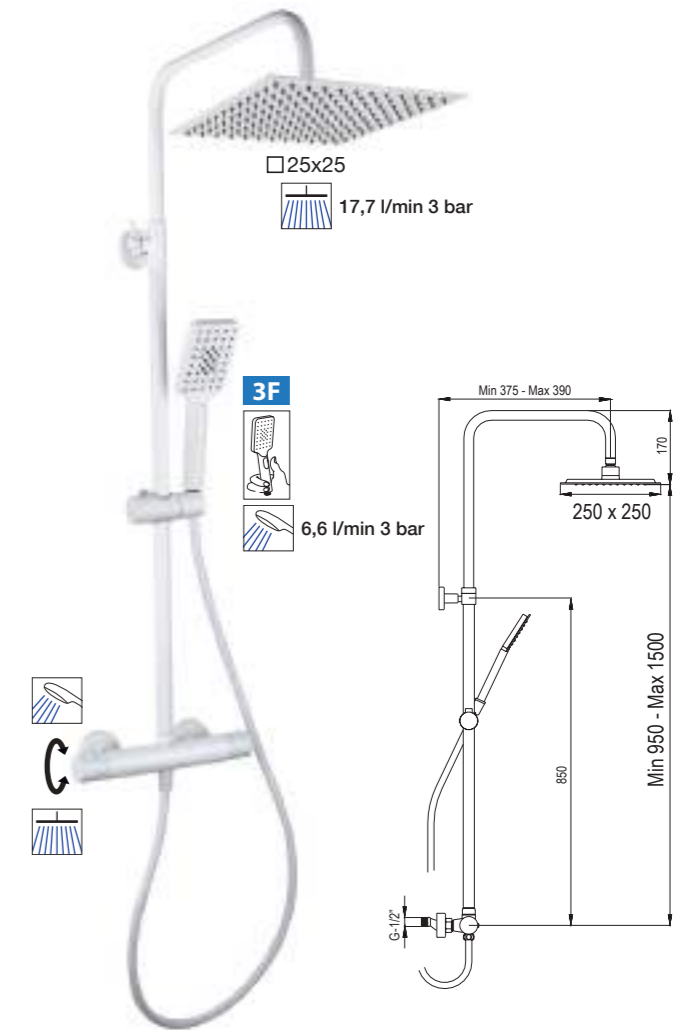

- Termostática con distribuidor incorporado
- Rociador de 25 x 25 cm, de acero inoxidable AISI 304
- Barra extensible de acero inoxidable AISI 304
- Flexo de PVC, antitorsión, 1,75 m

- Thermostatic mixer with integrated distributor
- Stainless steel AISI 304 shower head, 25 x 25 cm
- Stainless steel AISI 304 extensible bar
- PVC flexible hose, anti-twist, 1,75 m

- Thermostatique avec distributeur intégré
- Douche de tête de 25 x 25 cm, en acier inoxydable AISI 304
- Barre extensible en acier inoxydable AISI 304
- Flexible en PVC, anti-torsion, 1,75 m

- Termostatico con distributore integrato
- Soffione 25 x 25 cm, in acciaio inossidabile AISI 304
- Barra allungabile in acciaio inossidabile AISI 304
- Flessibile in PVC, anti-torsione, 1,75 m

20NITC25NID03

**OPCIONAL / OPTIONAL / OPTIONNEL / OPZIONALE**

**Reductor caudal 9 l/min ducha/rociador**  
 Flow rate reducer 9 l/min hand shower/shower head  
 Réducteur débit 9 l/min douchette/douche de tête  
 Riduttore portata da 9 l/min maniglia doccia/soffione

6024 

 9 l/min 3 bar

WIND BLU SQ



**OPCIONES DE ROCIADOR**  
 SHOWER HEAD OPTIONS  
 OPTIONS POUR DOUCHE DE TÊTE  
 OPZIONI PER SOFFIONE

**Wind Blu SQ**

en ABS  
 in ABS  
 en ABS  
 in ABS

22,5 x 22,5 cm

20WBC22OLB01

**Atlas C20**

en AISI 304  
 in AISI 304  
 en AISI 304  
 in AISI 304

20 x 20 cm

20WBC20OLB02

**Atlas C25**

en AISI 304  
 in AISI 304  
 en AISI 304  
 in AISI 304

25 x 25 cm

20WBC25OLB02

WIND BLU RD



**OPCIONES DE ROCIADOR**  
 SHOWER HEAD OPTIONS  
 OPTIONS POUR DOUCHE DE TÊTE  
 OPZIONI PER SOFFIONE

**Wind Blu RD**

en ABS  
 in ABS  
 en ABS  
 in ABS

Ø 24 cm

20WBR24OLB01

**Atlas R20**

en AISI 304  
 in AISI 304  
 en AISI 304  
 in AISI 304

Ø 20 cm

20WBR20OLB02

**Atlas R25**

en AISI 304  
 in AISI 304  
 en AISI 304  
 in AISI 304

Ø 25 cm

20WBR25OLB02

- Cartucho termostático Citec
- Termostática con distribuidor incorporado
- Barra extensible de acero inoxidable AISI 304
- Flexo de acero inoxidable doble grapado, antitorsión, 1,70 m

- Citec thermostatic cartridge
- Thermostatic mixer with integrated distributor
- Stainless steel AISI 304 extensible bar
- Stainless steel flexible hose double hooked, anti-twist, 1,70 m

- Cartouche thermostatique Citec
- Thermostatique avec distributeur intégré
- Barre extensible en acier inoxydable AISI 304
- Flexible en acier inoxydable double agrafage, anti-torsion, 1,70 m

- Cartuccia termostatica Citec
- Termostatico con distributore integrato
- Barra allungabile in acciaio inossidabile AISI 304
- Flessibile di doppia aggraffatura in acciaio inossidabile, anti-torsione, 1,70 m

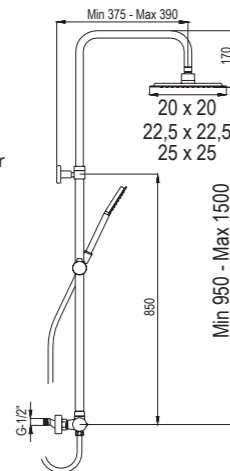

- Cartucho termostático Citec
- Termostática con distribuidor incorporado
- Barra extensible de acero inoxidable AISI 304
- Flexo de acero inoxidable doble grapado, antitorsión, 1,70 m

- Citec thermostatic cartridge
- Thermostatic mixer with integrated distributor
- Stainless steel AISI 304 extensible bar
- Stainless steel flexible hose double hooked, anti-twist, 1,70 m

- Cartouche thermostatique Citec
- Thermostatique avec distributeur intégré
- Barre extensible en acier inoxydable AISI 304
- Flexible en acier inoxydable double agrafage, anti-torsion, 1,70 m

- Cartuccia termostatica Citec
- Termostatico con distributore integrato
- Barra allungabile in acciaio inossidabile AISI 304
- Flessibile di doppia aggraffatura in acciaio inossidabile, anti-torsione, 1,70 m

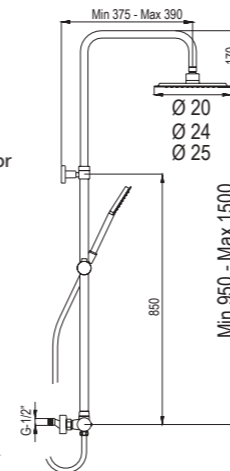

NITE

NEW

Disponibile: Mayo 2022 / Available: May 2022  
 Disponible: Mai 2022 / Disponibile: Maggio 2022



20NITC25NIB05

20NITR25NIB05

- Cartucho termostático Citec
- Termostática con distribuidor incorporado
- Barra extensible de acero inoxidable AISI 304
- Flexo de PVC, antitorsión, 1,75 m

- Citec thermostatic cartridge
- Thermostatic mixer with integrated distributor
- Stainless steel AISI 304 extensible bar
- PVC flexible hose, anti-twist, 1,75 m

- Cartouche thermostatique Citec
- Thermostatique avec distributeur intégré
- Barre extensible en acier inoxydable AISI 304
- Flexible en PVC, anti-torsion, 1,75 m

- Cartuccia termostatica Citec
- Termostatico con distributore integrato
- Barra allungabile in acciaio inossidabile AISI 304
- Flessibile in PVC, anti-torsione, 1,75 m

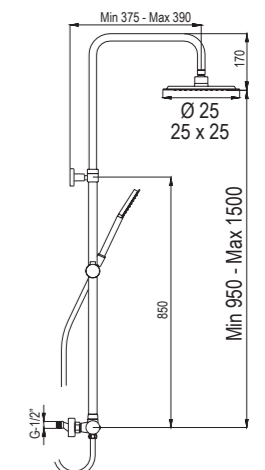

NEW OCEAN

NEW PACIFIC

WIND BLU SQ

WIND BLU RD

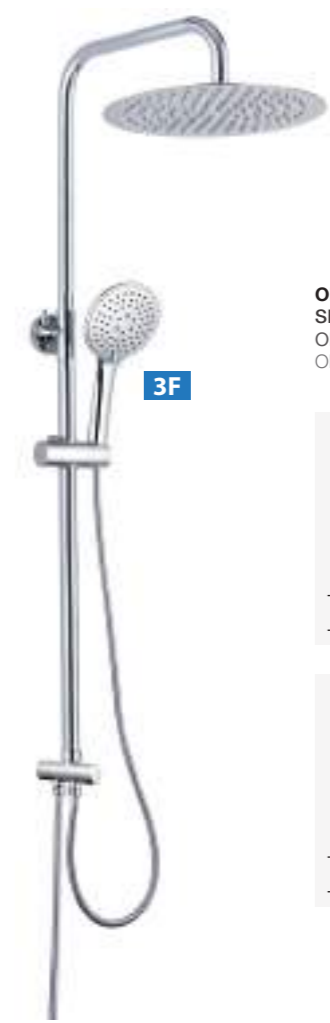
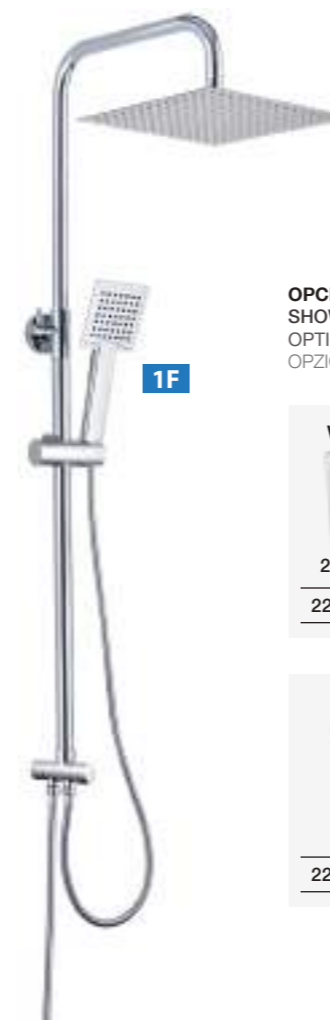
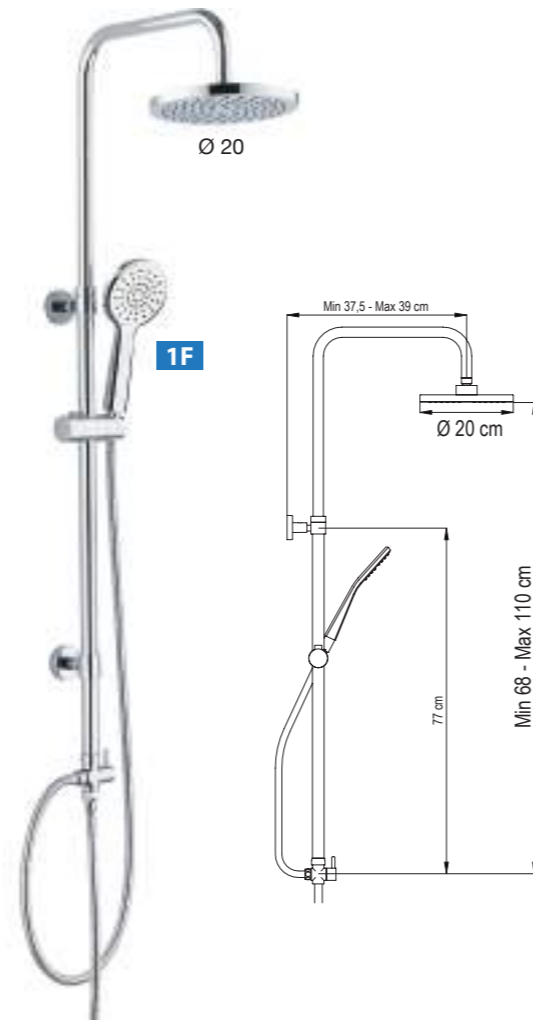
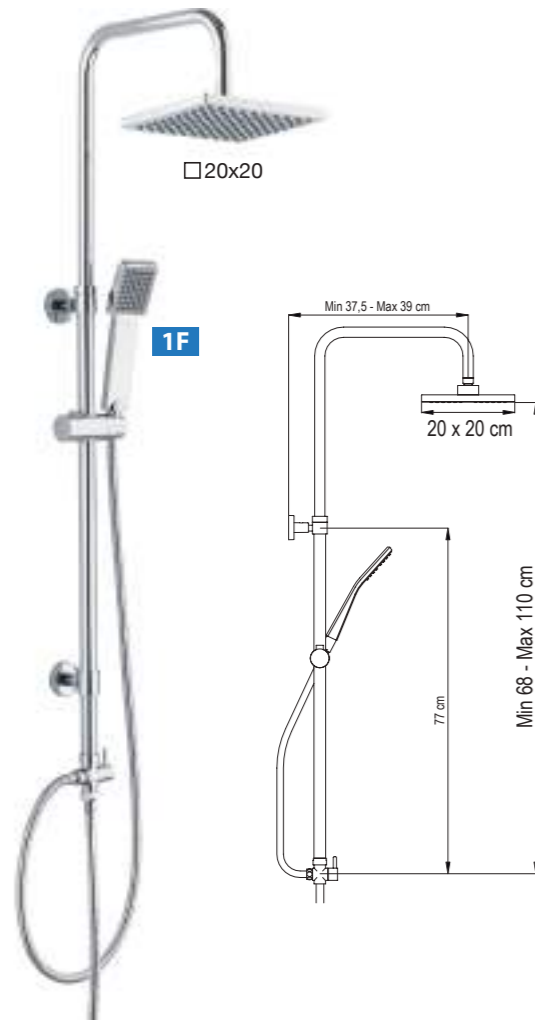

OPCIONES DE ROCIADOR  
 SHOWER HEAD OPTIONS  
 OPTIONS POUR DOUCHE DE TÊTE  
 OPZIONI PER SOFFIONE

**Wind Blu SQ**  
 en ABS  
 in ABS  
 en ABS  
 in ABS  
 22,5 x 22,5 cm  
 22WBC22SGR01

**Atlas C20**  
 en AISI 304  
 in AISI 304  
 en AISI 304  
 in AISI 304  
 20 x 20 cm  
 22WBC20SGR02

OPCIONES DE ROCIADOR  
 SHOWER HEAD OPTIONS  
 OPTIONS POUR DOUCHE DE TÊTE  
 OPZIONI PER SOFFIONE

**Wind Blu RD**  
 en ABS  
 in ABS  
 en ABS  
 in ABS  
 Ø 24 cm  
 22WBR24SGR01

**Atlas R20**  
 en AISI 304  
 in AISI 304  
 en AISI 304  
 in AISI 304  
 Ø 20 cm  
 22WBR20SGR02

- Inversor de latón cromado con montura cerámica. Con doble toma, para poder utilizar con grifería ya instalada
- Rociador de 20 x 20 cm, en ABS
- Barra extensible de acero inoxidable AISI 304
- Flexo de acero inoxidable doble grapado, antitorsión, 1,70 m

- Brass chromed diverter with ceramic headpart. With double outlet for faucets already installed
- ABS shower head, 20 x 20 cm
- Stainless steel AISI 304 extensible bar
- Stainless steel flexible shower hose double hooked, anti-twist, 1,70 m

- Déviateur en laiton chromé avec tête céramique. Fixation au mur, avec double prise, pour pouvoir utiliser avec robinetterie déjà installée
- Douche de tête de 20 x 20 cm, en ABS
- Barre extensible en acier inoxydable AISI 304
- Flexible en acier inoxydable double agrafage, anti-torsion, 1,70 m

- Deviatore in ottone cromato con vitone ceramico. Montaggio a parete, con doppio connettore, per utilizzare la rubinetteria già installata
- Soffione 20 x 20 cm, in ABS
- Barra allungabile in acciaio inossidabile AISI 304
- Flessibile di doppia aggraffatura in acciaio inossidabile, anti-torsione, 1,70 m

- Inversor de latón cromado con montura cerámica. Con doble toma, para poder utilizar con grifería ya instalada
- Rociador de Ø 20 cm, en ABS
- Barra extensible de acero inoxidable AISI 304
- Flexo de acero inoxidable doble grapado, antitorsión, 1,70 m

- Brass chromed diverter with ceramic headpart. With double outlet for faucets already installed
- ABS shower head, Ø 20 cm
- Stainless steel AISI 304 extensible bar
- Stainless steel flexible shower hose double hooked, anti-twist, 1,70 m

- Déviateur en laiton chromé avec tête céramique. Fixation au mur, avec double prise, pour pouvoir utiliser avec robinetterie déjà installée
- Douche de tête de Ø 20 cm, en ABS
- Barre extensible en acier inoxydable AISI 304
- Flexible en acier inoxydable double agrafage, anti-torsion, 1,70 m

- Deviatore in ottone cromato con vitone ceramico. Montaggio a parete, con doppio connettore, per utilizzare la rubinetteria già installata
- Soffione Ø 20 cm, in ABS
- Barra allungabile in acciaio inossidabile AISI 304
- Flessibile di doppia aggraffatura in acciaio inossidabile, anti-torsione, 1,70 m

- Inversor de latón cromado con montura cerámica. Con doble toma, para poder utilizar con grifería ya instalada
- Barra extensible de acero inoxidable AISI 304
- Flexo de acero inoxidable doble grapado, antitorsión, 1,70 m

- Brass chromed diverter with ceramic headpart. With double outlet for faucets already installed
- Stainless steel AISI 304 extensible bar
- Stainless steel flexible hose double hooked, anti-twist, 1,70 m

- Déviateur en laiton chromé avec tête céramique. Fixation au mur, avec double prise, pour pouvoir utiliser avec robinetterie déjà installée
- Barre extensible en acier inoxydable AISI 304
- Flexible en acier inoxydable double agrafage, anti-torsion, 1,70 m

- Deviatore in ottone cromato con vitone ceramico. Montaggio a parete, con doppio connettore, per utilizzare la rubinetteria già installata
- Barra allungabile in acciaio inossidabile AISI 304
- Flessibile di doppia aggraffatura in acciaio inossidabile, anti-torsione, 1,70 m

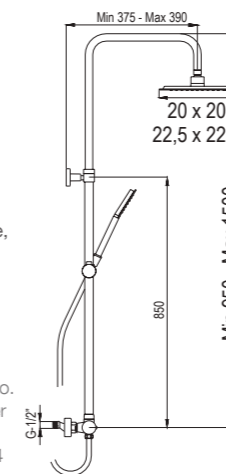

- Inversor de latón cromado con montura cerámica. Con doble toma, para poder utilizar con grifería ya instalada
- Barra extensible de acero inoxidable AISI 304
- Flexo de acero inoxidable doble grapado, antitorsión, 1,70 m

- Brass chromed diverter with ceramic headpart. With double outlet for faucets already installed
- Stainless steel AISI 304 extensible bar
- Stainless steel flexible hose double hooked, anti-twist, 1,70 m

- Déviateur en laiton chromé avec tête céramique. Fixation au mur, avec double prise, pour pouvoir utiliser avec robinetterie déjà installée
- Barre extensible en acier inoxydable AISI 304
- Flexible en acier inoxydable double agrafage, anti-torsion, 1,70 m

- Deviatore in ottone cromato con vitone ceramico. Montaggio a parete, con doppio connettore, per utilizzare la rubinetteria già installata
- Barra allungabile in acciaio inossidabile AISI 304
- Flessibile di doppia aggraffatura in acciaio inossidabile, anti-torsione, 1,70 m

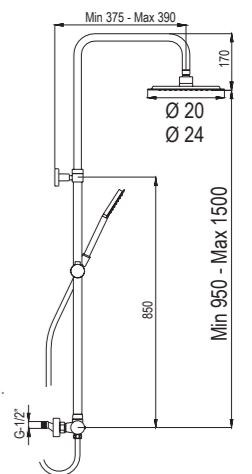

22NOSGR01

22NPSGR01





**KITS DE EMPOTRAR  
CONCEALED SETS  
ENSEMBLES À ENCASTRER  
INSIEMI DA INCASSO**



**KITS DE EMPOTRAR CON MONOMANDO / CONCEALED SETS WITH SINGLE LEVER**  
**ENSEMBLES À ENCASTRER AVEC MITIGEUR / INSIEMI DA INCASSO CON MISCELATORE**

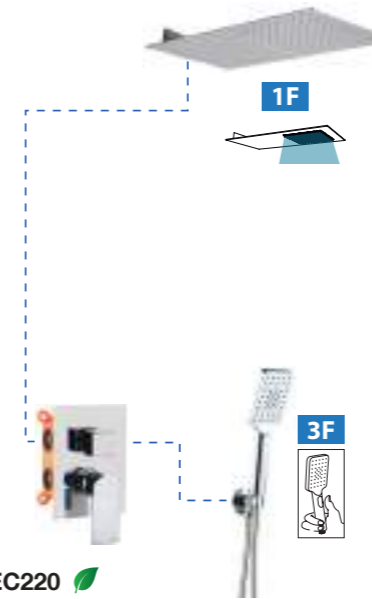

**KIT EC220**

**Monomando de empotrar con rociador y set de ducha**  
**Concealed shower mixer with shower head and shower set**  
**Mitigeur à encastrer avec douche de tête et kit de douche**  
**Miscelatore da incasso con soffione attacco e kit doccia**

**NEW** 7,1 l/min 3 bar 8,3 l/min 3 bar

**CON MANETA: / WITH LEVER: / AVEC LEVIER: / CON LEVA:**

<b>BOLD</b> 19BOLEC22002	<b>ALPHA</b> 19ALPEC22002
<b>DELTA</b> 19DELEC22002	<b>QB</b> 19QBEEC22002

**TODOS NUESTROS MONOMANDOS DE EMPOTRAR INCLUYEN:**  
 - Cuerpo fabricado por estampación en caliente de latón lo cual garantiza una perfecta estanqueidad del mismo por la ausencia de porosidades o fisuras.  
 - Caja de empotrar con nivel de burbuja incluido, que facilitan considerablemente la instalación del producto.  
 - Sistema de fácil acceso para el mantenimiento del cartucho y el inversor.

**TOUS NOS MITIGEURS ENCASTRABLES COMPRENENT :**  
 - Corps réalisé par forgeage à chaud du laiton qui garantit une parfaite étanchéité grâce à l'absence de porosité ou de fissures.  
 - Coffret d'encastrement avec niveau à bulle inclus, ce qui facilite grandement l'installation du produit.  
 - Système d'accès facile pour la maintenance des cartouches et des onduleurs.

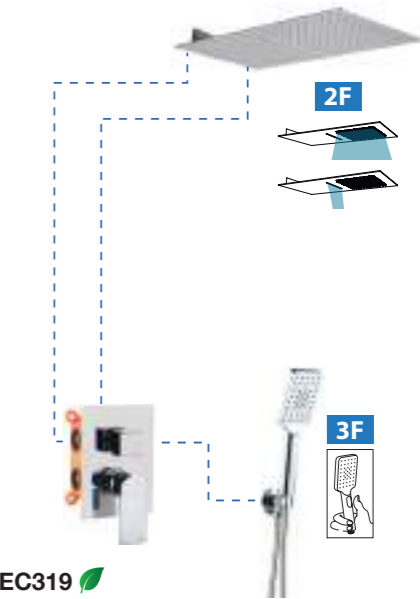
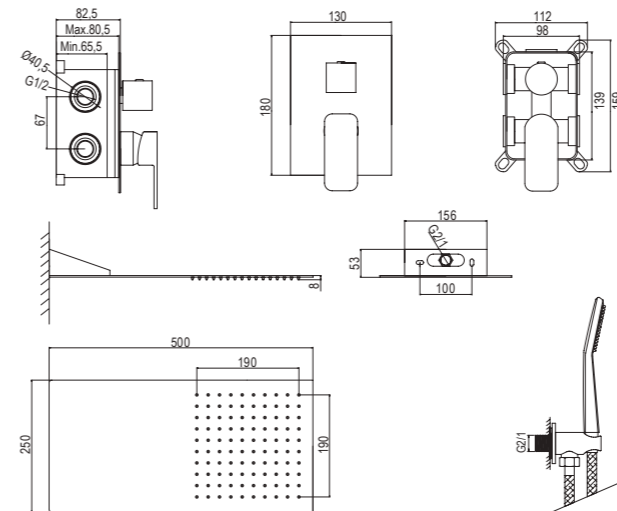

**KIT EC319**

**Monomando de empotrar con rociador y set de ducha**  
**Concealed shower mixer with shower head and shower set**  
**Mitigeur à encastrer avec douche de tête et kit de douche**  
**Miscelatore da incasso con soffione attacco e kit doccia**

**NEW** 7,1 l/min 3 bar 8,3 l/min 3 bar

**CON MANETA: / WITH LEVER: / AVEC LEVIER: / CON LEVA:**

<b>BOLD</b> 19BOLEC31902	<b>ALPHA</b> 19ALPEC31902
<b>DELTA</b> 19DELEC31902	<b>QB</b> 19QBEEC31902

**ALL OUR CONCEALED SINGLE LEVER MIXERS INCLUDE:**  
 - Body mixer manufactured by hot brass stamping which assures a perfect seal of the pieces due to absence of porosities or cracks.  
 - Concealed box with bubble level to facilitate its installation as much as possible.  
 - Easy-access system for cartridge and diverter maintenance.

**TUTTI I NOSTRI MISCELATORI DA INCASSO INCLUDONO:**  
 - Corpo realizzato mediante stampaggio a caldo di ottone che garantisce una perfetta tenuta dello stesso grazie all'assenza di porosità o fessurazioni.  
 - Scatola da incasso con livella a bolla inclusa, che facilita notevolmente l'installazione del prodotto.  
 - Sistema di facile accesso per la manutenzione della cartuccia e dell'inverter.

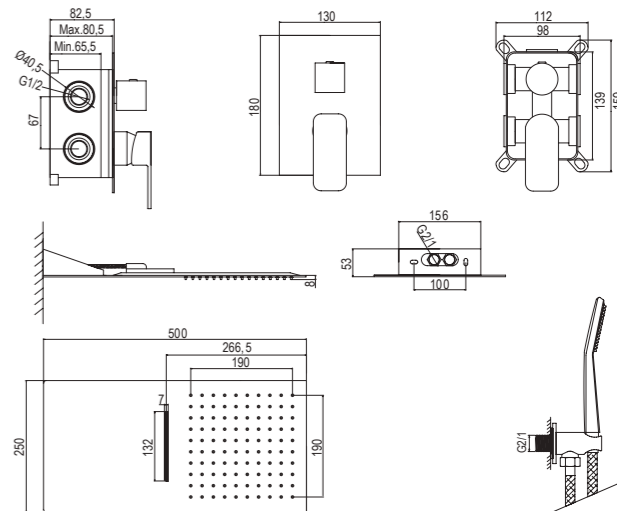

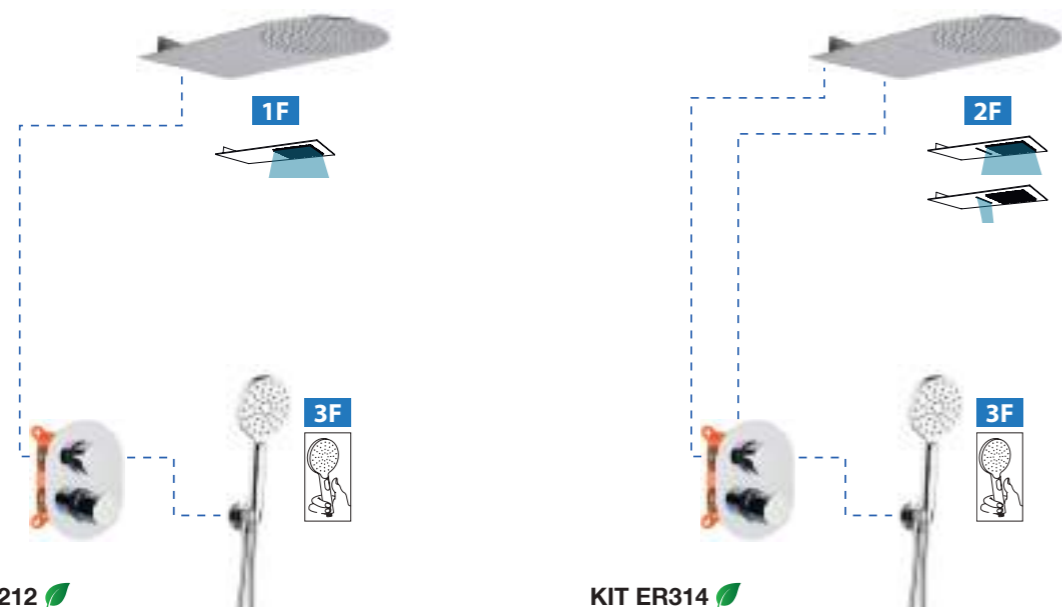

**KIT ER212**

**Monomando de empotrar con rociador y set de ducha**  
Concealed shower mixer with shower head and shower set  
Mitigeur à encastrer avec douche de tête et kit de douche  
Miscelatore da incasso con soffione attacco e kit doccia

**NEW** 6,7 l/min 3 bar 8,3 l/min 3 bar 35

**CON MANETA: / WITH LEVER: / AVEC LEVIER: / CON LEVA:**

<b>TUBE</b>	<b>BETA</b>
19TUBER21202	19BETER21202

**TODOS NUESTROS MONOMANDOS DE EMPOTRAR INCLUYEN:**  
- Cuerpo fabricado por estampación en caliente de latón lo cual garantiza una perfecta estanqueidad del mismo por la ausencia de porosidades o fisuras.  
- Caja de empotrar con nivel de burbuja incluido, que facilitan considerablemente la instalación del producto.  
- Sistema de fácil acceso para el mantenimiento del cartucho y el inversor.

**TOUS NOS MITIGEURS ENCASTRABLES COMPRENNENT :**  
- Corps réalisé par forgeage à chaud du laiton qui garantit une parfaite étanchéité grâce à l'absence de porosité ou de fissures.  
- Coffret d'encastrement avec niveau à bulle inclus, ce qui facilite grandement l'installation du produit.  
- Système d'accès facile pour la maintenance des cartouches et des onduleurs.

**KIT ER314**

**Monomando de empotrar con rociador y set de ducha**  
Concealed shower mixer with shower head and shower set  
Mitigeur à encastrer avec douche de tête et kit de douche  
Miscelatore da incasso con soffione attacco e kit doccia

**NEW** 6,7 l/min 3 bar 8,3 l/min 3 bar 35

**CON MANETA: / WITH LEVER: / AVEC LEVIER: / CON LEVA:**

<b>TUBE</b>	<b>BETA</b>
19TUBER31402	19BETER31402

**ALL OUR CONCEALED SINGLE LEVER MIXERS INCLUDE:**  
- Body mixer manufactured by hot brass stamping which assures a perfect seal of the pieces due to absence of porosities or cracks.  
- Concealed box with bubble level to facilitate its installation as much as possible.  
- Easy-access system for cartridge and diverter maintenance.

**TUTTI I NOSTRI MISCELATORI DA INCASSO INCLUDONO:**  
- Corpo realizzato mediante stampaggio a caldo di ottone che garantisce una perfetta tenuta dello stesso grazie all'assenza di porosità o fessurazioni.  
- Scatola da incasso con livella a bolla inclusa, che facilita notevolmente l'installazione del prodotto.  
- Sistema di facile accesso per la manutenzione della cartuccia e dell'inverter.

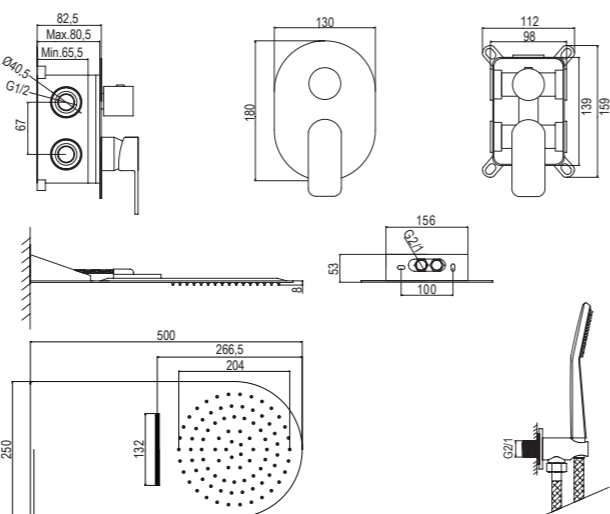
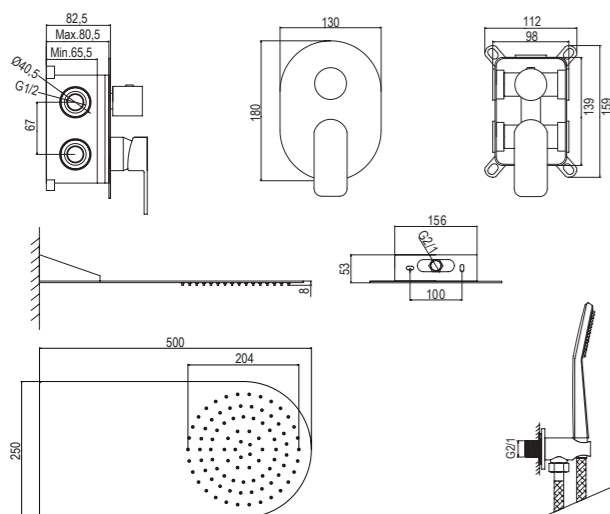



**KITS DE EMPOTRAR CON MONOMANDO / CONCEALED SETS WITH SINGLE LEVER**  
**ENSEMBLES À ENCASTRER AVEC MITIGEUR / INSIEMI DA INCASSO CON MISCELATORE**

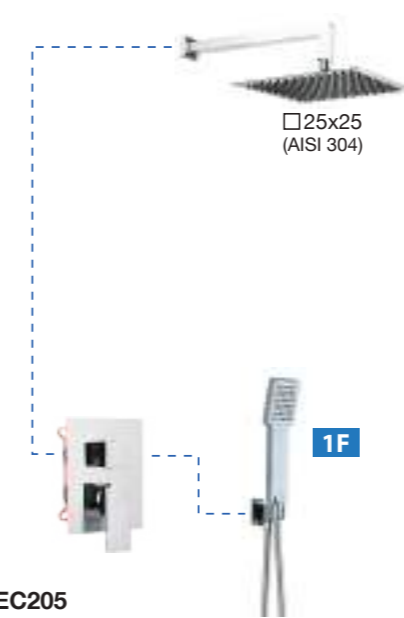

**KIT EC205**

**Monomando de empotrar con rociador y set de ducha**  
**Concealed shower mixer with shower head and shower set**  
 Mitigeur à encastrer avec douche de tête et kit de douche  
 Miselatore da incasso con soffione attacco e kit doccia



**CON MANETA: / WITH LEVER: / AVEC LEVIER: / CON LEVA:**

<b>BOLD</b> 19BOLEC20502	<b>ARLES</b> 19ARLEC20502
<b>DELTA</b> 19DELEC20502	<b>QB</b> 19QBEEC20502

**OPCIONAL / OPTIONAL / OPTIONNEL / OPZIONALE**

**Kit compuesto por 2 reductores ahorradores de caudal 9 l/min para mango de ducha y rociador**  
**Kit composed by 2 flow rate reducer 9 l/min for hand shower and head shower**

Kit composé de 2 réducteurs de débit 9l/min pour douchette et douche de tête  
 Kit composto da 2 riduttori di portata 9 l/min per maniglia doccia e soffione

6024X2



**TODOS NUESTROS MONOMANDOS DE EMPOTRAR INCLUYEN:**  
 - Cuerpo fabricado por estampación en caliente de latón lo cual garantiza una perfecta estanqueidad del mismo por la ausencia de porosidades o fisuras.  
 - Caja de empotrar con nivel de burbuja incluido, que facilitan considerablemente la instalación del producto.  
 - Sistema de fácil acceso para el mantenimiento del cartucho y el inversor.

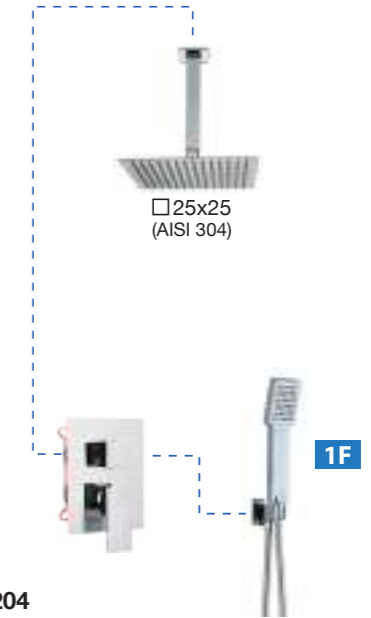
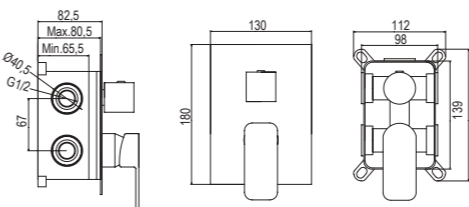

**KIT EC204**

**Monomando de empotrar con rociador y set de ducha**  
**Concealed shower mixer with shower head and shower set**  
 Mitigeur à encastrer avec douche de tête et kit de douche  
 Miselatore da incasso con soffione attacco e kit doccia



**CON MANETA: / WITH LEVER: / AVEC LEVIER: / CON LEVA:**

<b>BOLD</b> 19BOLEC20402	<b>ARLES</b> 19ARLEC20402
<b>DELTA</b> 19DELEC20402	<b>QB</b> 19QBEEC20402

**ALL OUR CONCEALED SINGLE LEVER MIXERS INCLUDE:**

- Body mixer manufactured by hot brass stamping which assures a perfect seal of the pieces due to absence of porosities or cracks.
- Concealed box with bubble level to facilitate its installation as much as possible.
- Easy-access system for cartridge and diverter maintenance.

**TOUS NOS MITIGEURS ENCASTRABLES COMPRENNENT :**

- Corps réalisé par forgeage à chaud du laiton qui garantit une parfaite étanchéité grâce à l'absence de porosité ou de fissures.
- Coffret d'encastrement avec niveau à bulle inclus, ce qui facilite grandement l'installation du produit.
- Système d'accès facile pour la maintenance des cartouches et des onduleurs.

**TUTTI I NOSTRI MISCELATORI DA INCASSO INCLUDONO:**

- Corpo realizzato mediante stampaggio a caldo di ottone che garantisce una perfetta tenuta dello stesso grazie all'assenza di porosità o fessurazioni.
- Scatola da incasso con livella a bolla inclusa, che facilita notevolmente l'installazione del prodotto.
- Sistema di facile accesso per la manutenzione della cartuccia e dell'inverter.

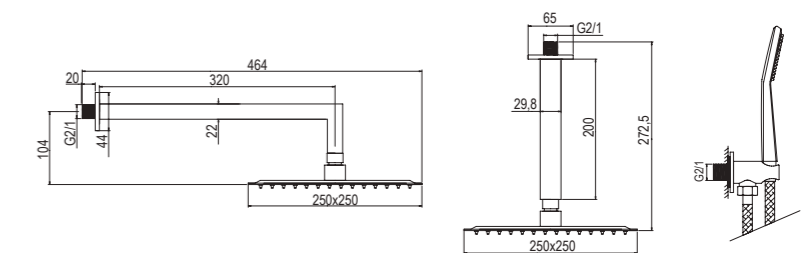

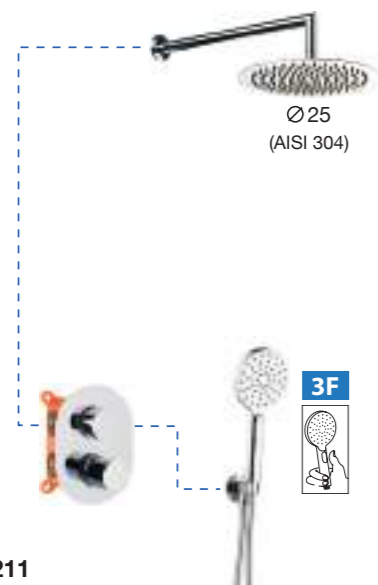

**KIT ER211**

**Monomando de empotrar con rociador y set de ducha**  
Concealed shower mixer with shower head and shower set  
Mitigeur à encastrer avec douche de tête et kit de douche  
Miscelatore da incasso con soffione attacco e kit doccia



CON MANETA: / WITH LEVER: / AVEC LEVIER: / CON LEVA:

<b>TUBE</b>	<b>BETA</b>
19TUBER21102	19BETER21102



**KIT ER217**

**Monomando de empotrar con rociador y set de ducha**  
Concealed shower mixer with shower head and shower set  
Mitigeur à encastrer avec douche de tête et kit de douche  
Miscelatore da incasso con soffione attacco e kit doccia



CON MANETA: / WITH LEVER: / AVEC LEVIER: / CON LEVA:

<b>TUBE</b>	<b>BETA</b>
19TUBER21702	19BETER21702

OPCIONAL / OPTIONAL / OPTIONNEL / OPZIONALE

**Reductor ahorrador de caudal 9 l/min para mango de ducha y/o rociador de techo y pared**

Flow rate reducer 9 l/min for hand shower and/or wall or ceiling shower head  
Réducteur de débit 9 l/min pour douchette et/ou douche de tête plafond et mur  
Riduttore di portata da 9 l/min per maniglia doccia e/o irrigatore a soffitto e parete

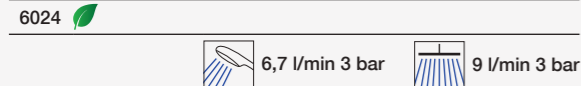

**TODOS NUESTROS MONOMANDOS DE EMPOTRAR INCLUYEN:**  
- Cuerpo fabricado por estampación en caliente de latón lo cual garantiza una perfecta estanqueidad del mismo por la ausencia de porosidades o fisuras.  
- Caja de empotrar con nivel de burbuja incluido, que facilitan considerablemente la instalación del producto.  
- Sistema de fácil acceso para el mantenimiento del cartucho y el inversor.

**ALL OUR CONCEALED SINGLE LEVER MIXERS INCLUDE:**  
- Body mixer manufactured by hot brass stamping which assures a perfect seal of the pieces due to absence of porosities or cracks.  
- Concealed box with bubble level to facilitate its installation as much as possible.  
- Easy-access system for cartridge and diverter maintenance.

**TOUS NOS MITIGEURS ENCASTRABLES COMPRENNENT :**  
- Corps réalisé par forgeage à chaud du laiton qui garantit une parfaite étanchéité grâce à l'absence de porosité ou de fissures.  
- Coffret d'encastrement avec niveau à bulle inclus, ce qui facilite grandement l'installation du produit.  
- Système d'accès facile pour la maintenance des cartouches et des onduleurs.

**TUTTI I NOSTRI MISCELATORI DA INCASSO INCLUDONO:**  
- Corpo realizzato mediante stampaggio a caldo di ottone che garantisce una perfetta tenuta dello stesso grazie all'assenza di porosità o fessurazioni.  
- Scatola da incasso con livella a bolla inclusa, che facilita notevolmente l'installazione del prodotto.  
- Sistema di facile accesso per la manutenzione della cartuccia e dell'inverter.

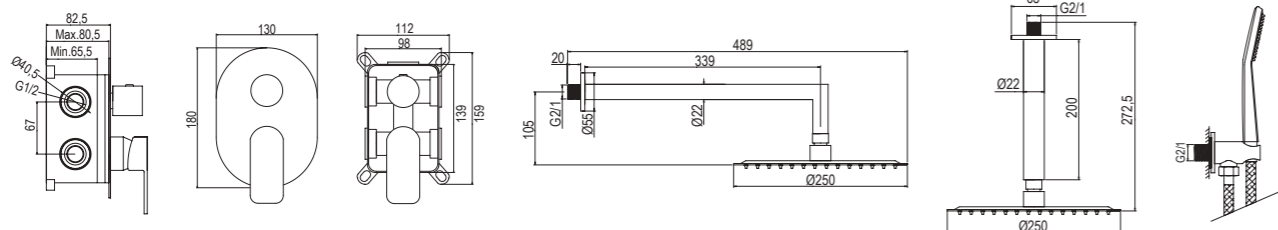



**KITS DE EMPOTRAR CON MONOMANDO / CONCEALED SETS WITH SINGLE LEVER**  
**ENSEMBLES À ENCASTRER AVEC MITIGEUR / INSIEMI DA INCASSO CON MISCELATORE**

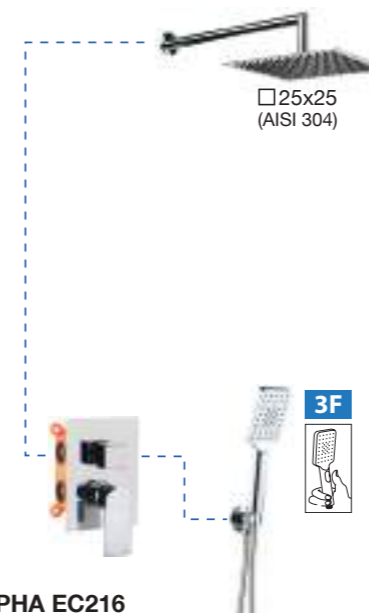

**KIT ALPHA EC216**

**Monomando de empotrar con rociador y set de ducha**  
 Concealed shower mixer with shower head and shower set  
 Mitigeur à encastrer avec douche de tête et kit de douche  
 Miscelatore da incasso con soffione attacco e kit doccia

19ALPEC21602

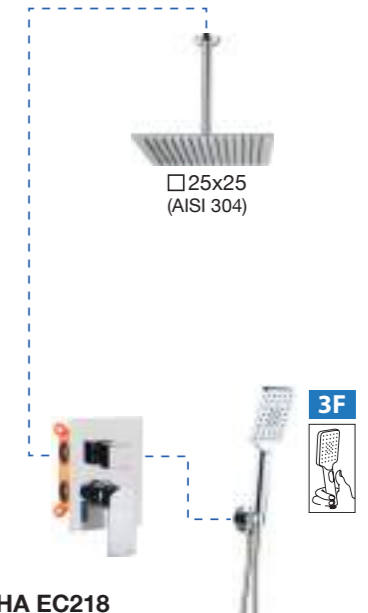
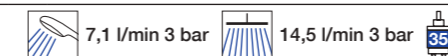

**KIT ALPHA EC218**

**Monomando de empotrar con rociador y set de ducha**  
 Concealed shower mixer with shower head and shower set  
 Mitigeur à encastrer avec douche de tête et kit de douche  
 Miscelatore da incasso con soffione attacco e kit doccia

19ALPEC21802

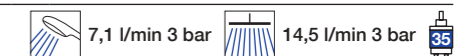

**OPCIONAL / OPTIONAL / OPTIONNEL / OPZIONALE**

**Reductor ahorrador de caudal 9 l/min para mango de ducha y/o rociador de techo y pared**  
 Flow rate reducer 9 l/min for hand shower and/or wall or ceiling shower head  
 Réducteur de débit 9 l/min pour douchette et/ou douche de tête plafond et mur  
 Riduttore di portata da 9 l/min per maniglia doccia e/o irrigatore a soffitto e parete

6024



**ALL OUR CONCEALED SINGLE LEVER MIXERS INCLUDE:**  
 - Body mixer manufactured by hot brass stamping which assures a perfect seal of the pieces due to absence of porosities or cracks.  
 - Concealed box with bubble level to facilitate its installation as much as possible.  
 - Easy-access system for cartridge and diverter maintenance.

**TOUS NOS MITIGEURS ENCASTRABLES COMPRENNENT :**  
 - Corps réalisé par forgeage à chaud du laiton qui garantit une parfaite étanchéité grâce à l'absence de porosité ou de fissures.  
 - Coffret d'encastrement avec niveau à bulle inclus, ce qui facilite grandement l'installation du produit.  
 - Système d'accès facile pour la maintenance des cartouches et des onduleurs.

**TODOS NUESTROS MONOMANDOS DE EMPOTRAR INCLUYEN:**  
 - Cuerpo fabricado por estampación en caliente de latón lo cual garantiza una perfecta estanqueidad del mismo por la ausencia de porosidades o fisuras.  
 - Caja de empotrar con nivel de burbuja incluido, que facilitan considerablemente la instalación del producto.  
 - Sistema de fácil acceso para el mantenimiento del cartucho y el inversor.

**TUTTI I NOSTRI MISCELATORI DA INCASSO INCLUDONO:**  
 - Corpo realizzato mediante stampaggio a caldo di ottone che garantisce una perfetta tenuta dello stesso grazie all'assenza di porosità o fessurazioni.  
 - Scatola da incasso con livella a bolla inclusa, che facilita notevolmente l'installazione del prodotto.  
 - Sistema di facile accesso per la manutenzione della cartuccia e dell'inverter.

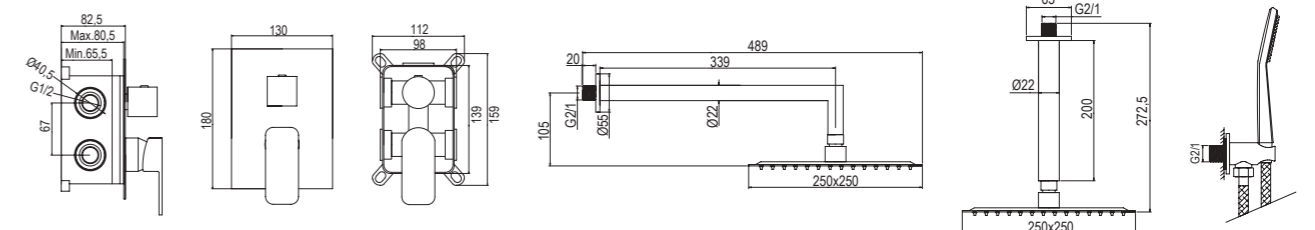



### KIT ER205

Monomando de empotrar con rociador y set de ducha  
 Concealed shower mixer with shower head and shower set  
 Mitigeur à encastrer avec douche de tête et kit de douche  
 Miscelatore da incasso con soffione attacco e kit doccia

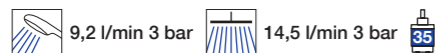

CON MANETA: / WITH LEVER: / AVEC LEVIER: / CON LEVA:

<b>SKY</b> 19SKYER20502	<b>LILE</b> 19LILER20502
<b>VENT-i2</b> 19VE2ER20502	



### KIT ER204

Monomando de empotrar con rociador y set de ducha  
 Concealed shower mixer with shower head and shower set  
 Mitigeur à encastrer avec douche de tête et kit de douche  
 Miscelatore da incasso con soffione attacco e kit doccia

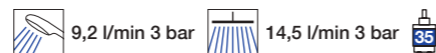

CON MANETA: / WITH LEVER: / AVEC LEVIER: / CON LEVA:

<b>SKY</b> 19SKYER20402	<b>LILE</b> 19LILER20402
<b>VENT-i2</b> 19VE2ER20402	

### OPCIONAL / OPTIONAL / OPTIONNEL / OPZIONALE

Reductor ahorrador de caudal 9 l/min para mango de ducha y/o rociador de techo y pared  
 Flow rate reducer 9 l/min for hand shower and/or wall or ceiling shower head  
 Réducteur de débit 9 l/min pour douchette et/ou douche de tête plafond et mur  
 Riduttore di portata da 9 l/min per maniglia doccia e/o irrigatore a soffitto e parete

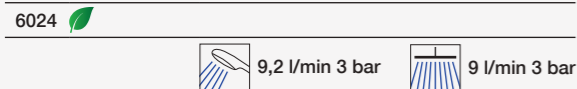

**TODOS NUESTROS MONOMANDOS DE EMPOTRAR INCLUYEN:**  
 - Cuerpo fabricado por estampación en caliente de latón lo cual garantiza una perfecta estanqueidad del mismo por la ausencia de porosidades o fisuras.  
 - Caja de empotrar con nivel de burbuja incluido, que facilitan considerablemente la instalación del producto.  
 - Sistema de fácil acceso para el mantenimiento del cartucho y el inversor.

ALL OUR CONCEALED SINGLE LEVER MIXERS INCLUDE:  
 - Body mixer manufactured by hot brass stamping which assures a perfect seal of the pieces due to absence of porosities or cracks.  
 - Concealed box with bubble level to facilitate its installation as much as possible.  
 - Easy-access system for cartridge and diverter maintenance.

TOUS NOS MITIGEURS ENCASTRABLES COMPRENNENT :  
 - Corps réalisé par forgeage à chaud du laiton qui garantit une parfaite étanchéité grâce à l'absence de porosité ou de fissures.  
 - Coffret d'encastrement avec niveau à bulle inclus, ce qui facilite grandement l'installation du produit.  
 - Système d'accès facile pour la maintenance des cartouches et des onduleurs.

TUTTI I NOSTRI MISCELATORI DA INCASSO INCLUDONO:  
 - Corpo realizzato mediante stampaggio a caldo di ottone che garantisce una perfetta tenuta dello stesso grazie all'assenza di porosità o fessurazioni.  
 - Scatola da incasso con livella a bolla inclusa, che facilita notevolmente l'installazione del prodotto.  
 - Sistema di facile accesso per la manutenzione della cartuccia e dell'invertor.

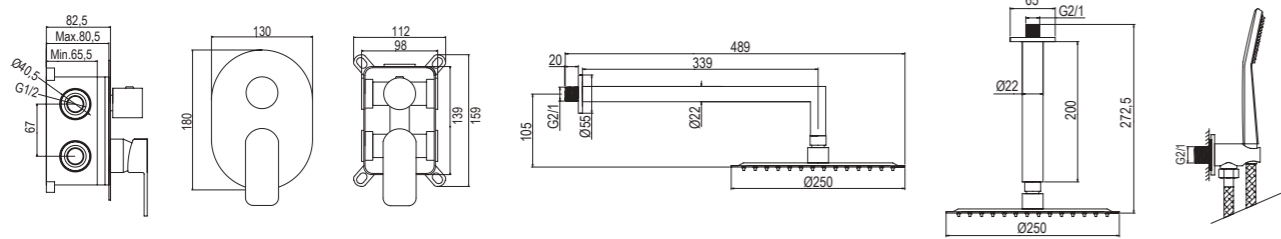



**KITS DE EMPOTRAR CON MONOMANDO / CONCEALED SETS WITH SINGLE LEVER**  
**ENSEMBLES À ENCASTRER AVEC MITIGEUR / INSIEMI DA INCASSO CON MISCELATORE**

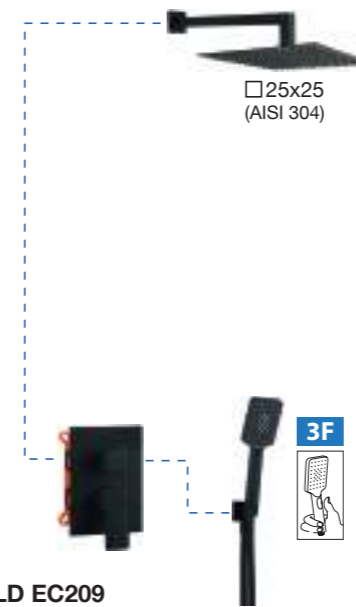

**KIT BOLD EC209**

**Monomando de empotrar con rociador y set de ducha**  
 Concealed shower mixer with shower head and shower set  
 Mitigeur à encastrer avec douche de tête et kit de douche  
 Miscelatore da incasso con soffione attacco e kit doccia

19BOLEC20905



**KIT BOLD EC217**

**Monomando de empotrar con rociador y set de ducha**  
 Concealed shower mixer with shower head and shower set  
 Mitigeur à encastrer avec douche de tête et kit de douche  
 Miscelatore da incasso con soffione attacco e kit doccia

19BOLEC21705



**OPCIONAL / OPTIONAL / OPTIONNEL / OPZIONALE**

**Reductor ahorrador de caudal 9 l/min para mango de ducha y/o rociador de techo y pared**  
 Flow rate reducer 9 l/min for hand shower and/or wall or ceiling shower head  
 Réducteur de débit 9 l/min pour douchette et/ou douche de tête plafond et mur  
 Riduttore di portata da 9 l/min per maniglia doccia e/o irrigatore a soffitto e parete

6024

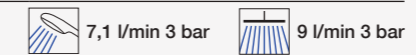

**ALL OUR CONCEALED SINGLE LEVER MIXERS INCLUDE:**  
 - Body mixer manufactured by hot brass stamping which assures a perfect seal of the pieces due to absence of porosities or cracks.  
 - Concealed box with bubble level to facilitate its installation as much as possible.  
 - Easy-access system for cartridge and diverter maintenance.

**TOUTS NOS MITIGEURS ENCASTRABLES COMPRENNENT :**  
 - Corps réalisé par forgeage à chaud du laiton qui garantit une parfaite étanchéité grâce à l'absence de porosité ou de fissures.  
 - Coffret d'encastrement avec niveau à bulle inclus, ce qui facilite grandement l'installation du produit.  
 - Système d'accès facile pour la maintenance des cartouches et des onduleurs.

**TODOS NUESTROS MONOMANDOS DE EMPOTRAR INCLUYEN:**  
 - Cuerpo fabricado por estampación en caliente de latón lo cual garantiza una perfecta estanqueidad del mismo por la ausencia de porosidades o fisuras.  
 - Caja de empotrar con nivel de burbuja incluido, que facilitan considerablemente la instalación del producto.  
 - Sistema de fácil acceso para el mantenimiento del cartucho y el inversor.

**TUTTI I NOSTRI MISCELATORI DA INCASSO INCLUDONO:**  
 - Corpo realizzato mediante stampaggio a caldo di ottone che garantisce una perfetta tenuta dello stesso grazie all'assenza di porosità o fessurazioni.  
 - Scatola da incasso con livella a bolla inclusa, che facilita notevolmente l'installazione del prodotto.  
 - Sistema di facile accesso per la manutenzione della cartuccia e dell'inverter.

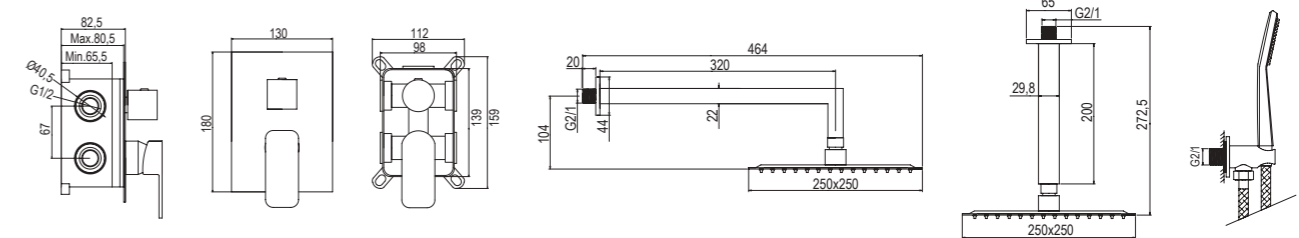





#### KIT ER208

**Monomando de empotrar con rociador y set de ducha**  
Concealed shower mixer with shower head and shower set  
Mitigeur à encastrer avec douche de tête et kit de douche  
Miscelatore da incasso con soffione attacco e kit doccia



#### KIT ER217

**Monomando de empotrar con rociador y set de ducha**  
Concealed shower mixer with shower head and shower set  
Mitigeur à encastrer avec douche de tête et kit de douche  
Miscelatore da incasso con soffione attacco e kit doccia



CON MANETA: / WITH LEVER: / AVEC LEVIER: / CON LEVA:

CON MANETA: / WITH LEVER: / AVEC LEVIER: / CON LEVA:

<b>TUBE</b>	<b>BETA</b>
19TUBER20805	19BETER20805

<b>TUBE</b>	<b>BETA</b>
19TUBER21705	19BETER21705

#### OPCIONAL / OPTIONAL / OPTIONNEL / OPZIONALE

##### Reductor ahorrador de caudal 9 l/min para mango de ducha y/o rociador de techo y pared

Flow rate reducer 9 l/min for hand shower and/or wall or ceiling shower head  
Réducteur de débit 9 l/min pour douchette et/ou douche de tête plafond et mur  
Riduttore di portata da 9 l/min per maniglia doccia e/o irrigatore a soffitto e parete

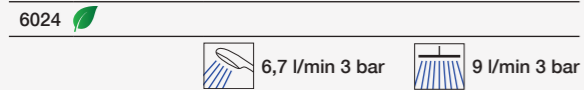

#### ALL OUR CONCEALED SINGLE LEVER MIXERS INCLUDE:

- Body mixer manufactured by hot brass stamping which assures a perfect seal of the pieces due to absence of porosities or cracks.
- Concealed box with bubble level to facilitate its installation as much as possible.
- Easy-access system for cartridge and diverter maintenance.

#### TOUS NOS MITIGEURS ENCASTRABLES COMPRENNENT :

- Corps réalisé par forgeage à chaud du laiton qui garantit une parfaite étanchéité grâce à l'absence de porosité ou de fissures.
- Coffret d'encastrement avec niveau à bulle inclus, ce qui facilite grandement l'installation du produit.
- Système d'accès facile pour la maintenance des cartouches et des onduleurs.

#### TODOS NUESTROS MONOMANDOS DE EMPOTRAR INCLUYEN:

- Cuerpo fabricado por estampación en caliente de latón lo cual garantiza una perfecta estanqueidad del mismo por la ausencia de porosidades o fisuras.
- Caja de empotrar con nivel de burbuja incluido, que facilitan considerablemente la instalación del producto.
- Sistema de fácil acceso para el mantenimiento del cartucho y el inversor.

#### TUTTI I NOSTRI MISCELATORI DA INCASSO INCLUDONO:

- Corpo realizzato mediante stampaggio a caldo di ottone che garantisce una perfetta tenuta dello stesso grazie all'assenza di porosità o fessurazioni.
- Scatola da incasso con livella a bolla inclusa, che facilita notevolmente l'installazione del prodotto.
- Sistema di facile accesso per la manutenzione della cartuccia e dell'inverter.

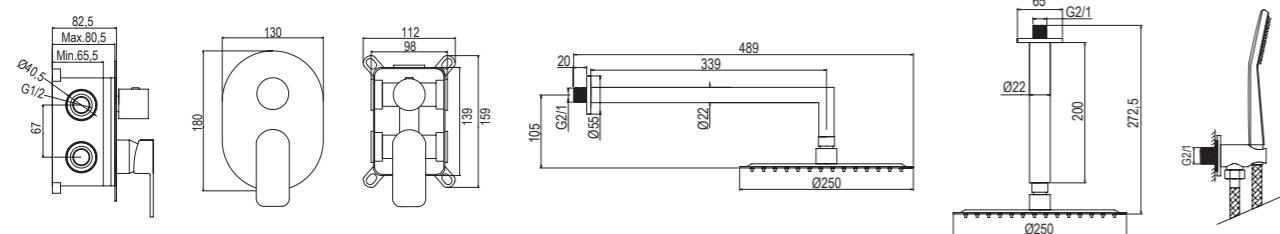



**KITS DE EMPOTRAR CON MONOMANDO / CONCEALED SETS WITH SINGLE LEVER**  
**ENSEMBLES À ENCASTRER AVEC MITIGEUR / INSIEMI DA INCASSO CON MISCELATORE**

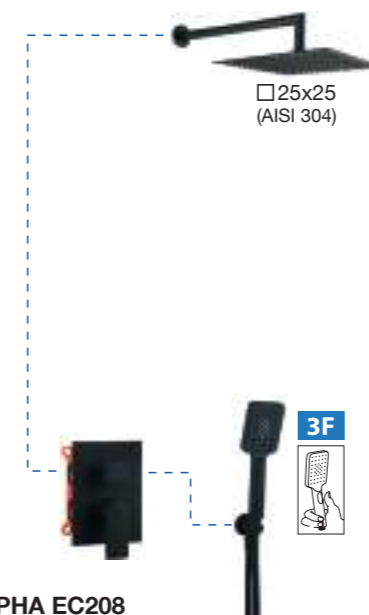

**KIT ALPHA EC208**

**Monomando de empotrar con rociador y set de ducha**  
 Concealed shower mixer with shower head and shower set  
 Mitigeur à encastrer avec douche de tête et kit de douche  
 Miscelatore da incasso con soffione attacco e kit doccia

19ALPEC20805

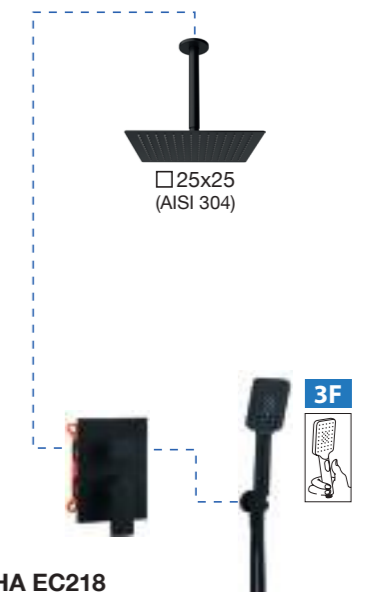
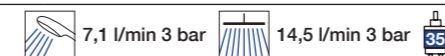

**KIT ALPHA EC218**

**Monomando de empotrar con rociador y set de ducha**  
 Concealed shower mixer with shower head and shower set  
 Mitigeur à encastrer avec douche de tête et kit de douche  
 Miscelatore da incasso con soffione attacco e kit doccia

19ALPEC21805

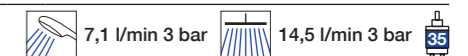

**OPCIONAL / OPTIONAL / OPTIONNEL / OPZIONALE**

**Reductor ahorrador de caudal 9 l/min para mango de ducha y/o rociador de techo y pared**

Flow rate reducer 9 l/min for hand shower and/or wall or ceiling shower head  
 Réducteur de débit 9 l/min pour douchette et/ou douche de tête plafond et mur  
 Riduttore di portata da 9 l/min per maniglia doccia e/o irrigatore a soffitto e parete

6024

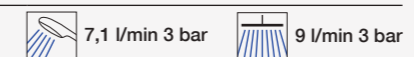

**ALL OUR CONCEALED SINGLE LEVER MIXERS INCLUDE:**

- Body mixer manufactured by hot brass stamping which assures a perfect seal of the pieces due to absence of porosities or cracks.
- Concealed box with bubble level to facilitate its installation as much as possible.
- Easy-access system for cartridge and diverter maintenance.

**TOUS NOS MITIGEURS ENCASTRABLES COMPRENNENT :**

- Corps réalisé par forgeage à chaud du laiton qui garantit une parfaite étanchéité grâce à l'absence de porosité ou de fissures.
- Coffret d'encastrement avec niveau à bulle inclus, ce qui facilite grandement l'installation du produit.
- Système d'accès facile pour la maintenance des cartouches et des onduleurs.

**TODOS NUESTROS MONOMANDOS DE EMPOTRAR INCLUYEN:**

- **Cuerpo fabricado por estampación en caliente de latón lo cual garantiza una perfecta estanqueidad del mismo por la ausencia de porosidades o fisuras.**
- **Caja de empotrar con nivel de burbuja incluido, que facilitan considerablemente la instalación del producto.**
- **Sistema de fácil acceso para el mantenimiento del cartucho y el inversor.**

**TUTTI I NOSTRI MISCELATORI DA INCASSO INCLUDONO:**

- **Corpo realizzato mediante stampaggio a caldo di ottone che garantisce una perfetta tenuta dello stesso grazie all'assenza di porosità o fessurazioni.**
- **Scatola da incasso con livella a bolla inclusa, che facilita notevolmente l'installazione del prodotto.**
- **Sistema di facile accesso per la manutenzione della cartuccia e dell'inverter.**

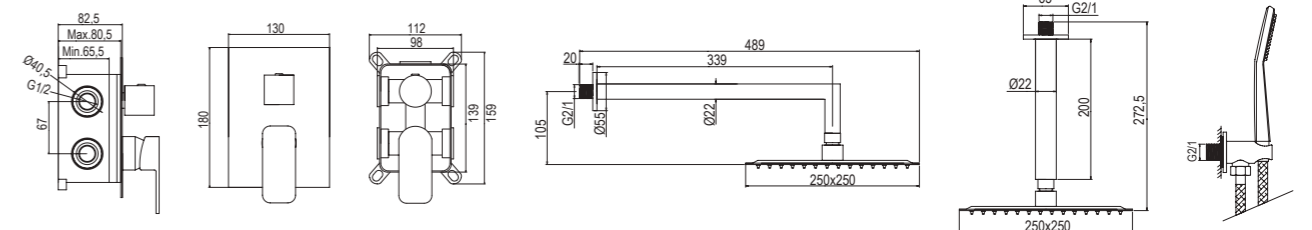

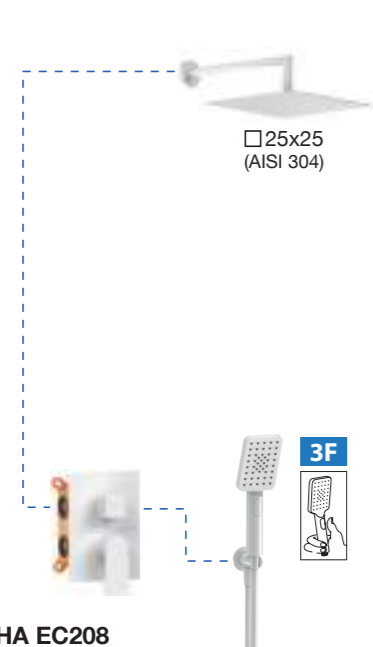

#### KIT ALPHA EC208

**Monomando de empotrar con rociador y set de ducha**  
Concealed shower mixer with shower head and shower set  
Mitigeur à encastrer avec douche de tête et kit de douche  
Miscelatore da incasso con soffione attacco e kit doccia

19ALPEC20803



#### KIT ALPHA EC218

**Monomando de empotrar con rociador y set de ducha**  
Concealed shower mixer with shower head and shower set  
Mitigeur à encastrer avec douche de tête et kit de douche  
Miscelatore da incasso con soffione attacco e kit doccia

19ALPEC21803



#### OPCIONAL / OPTIONAL / OPTIONNEL / OPZIONALE

##### Reductor ahorrador de caudal 9 l/min para mango de ducha y/o rociador de techo y pared

Flow rate reducer 9 l/min for hand shower and/or wall or ceiling shower head  
Réducteur de débit 9 l/min pour douchette et/ou douche de tête plafond et mur  
Riduttore di portata da 9 l/min per maniglia doccia e/o irrigatore a soffitto e parete

6024

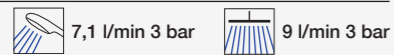

#### ALL OUR CONCEALED SINGLE LEVER MIXERS INCLUDE:

- Body mixer manufactured by hot brass stamping which assures a perfect seal of the pieces due to absence of porosities or cracks.
- Concealed box with bubble level to facilitate its installation as much as possible.
- Easy-access system for cartridge and diverter maintenance.

#### TOUS NOS MITIGEURS ENCASTRABLES COMPRENNENT :

- Corps réalisé par forgeage à chaud du laiton qui garantit une parfaite étanchéité grâce à l'absence de porosité ou de fissures.
- Coffret d'encastrement avec niveau à bulle inclus, ce qui facilite grandement l'installation du produit.
- Système d'accès facile pour la maintenance des cartouches et des onduleurs.

#### TODOS NUESTROS MONOMANDOS DE EMPOTRAR INCLUYEN:

- Cuerpo fabricado por estampación en caliente de latón lo cual garantiza una perfecta estanqueidad del mismo por la ausencia de porosidades o fisuras.
- Caja de empotrar con nivel de burbuja incluido, que facilitan considerablemente la instalación del producto.
- Sistema de fácil acceso para el mantenimiento del cartucho y el inversor.

#### TUTTI I NOSTRI MISCELATORI DA INCASSO INCLUDONO:

- Corpo realizzato mediante stampaggio a caldo di ottone che garantisce una perfetta tenuta dello stesso grazie all'assenza di porosità o fessurazioni.
- Scatola da incasso con livella a bolla inclusa, che facilita notevolmente l'installazione del prodotto.
- Sistema di facile accesso per la manutenzione della cartuccia e dell'inverter.

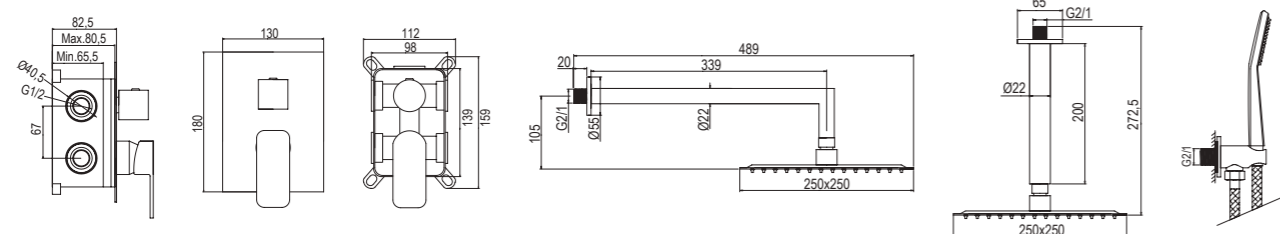

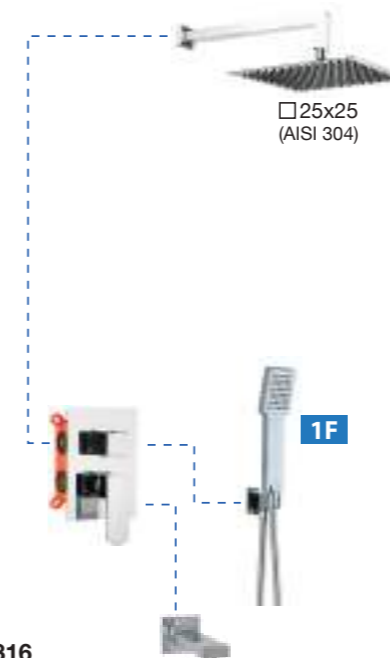

### KIT EC316

**Monomando de empotrar con rociador, set de ducha y caño de bañera**  
 Concealed shower mixer with shower head, shower set and bathtub spout  
 Mitigeur à encastrer avec douche de tête, kit de douche et bec de baignoire  
 Miscelatore da incasso con soffione attacco, kit doccia e getto di vasca

22,6 l/min 2 bar 10,8 l/min 3 bar 14,5 l/min 3 bar

CON MANETA: / WITH LEVER: / AVEC LEVIER: / CON LEVA:

<b>BOLD</b> 19BOLEC31602	<b>ARLES</b> 19ARLEC31602
<b>DELTA</b> 19DELEC31602	<b>QB</b> 19QBEEC31602

**TODOS NUESTROS MONOMANDOS DE EMPOTRAR INCLUYEN:**  
 - Cuerpo fabricado por estampación en caliente de latón lo cual garantiza una perfecta estanqueidad del mismo por la ausencia de porosidades o fisuras.  
 - Caja de empotrar con nivel de burbuja incluido, que facilitan considerablemente la instalación del producto.  
 - Sistema de fácil acceso para el mantenimiento del cartucho y el inversor.

**TOUS NOS MITIGEURS ENCASTRABLES COMPRENNENT :**  
 - Corps réalisé par forgeage à chaud du laiton qui garantit une parfaite étanchéité grâce à l'absence de porosité ou de fissures.  
 - Coffret d'encastrement avec niveau à bulle inclus, ce qui facilite grandement l'installation du produit.  
 - Système d'accès facile pour la maintenance des cartouches et des onduleurs.

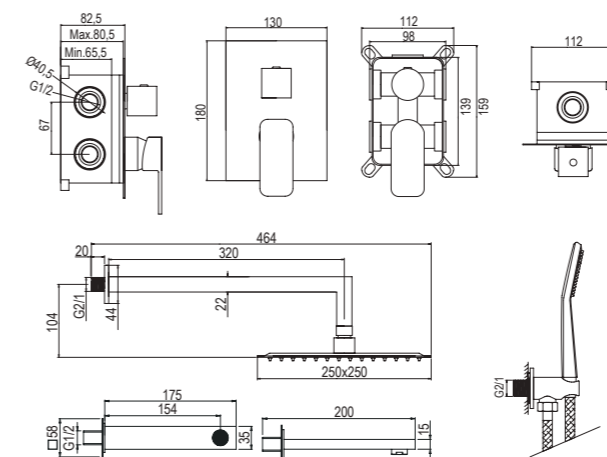

### KIT ER316 NEW

**Monomando de empotrar con rociador, set de ducha y caño de bañera**  
 Concealed shower mixer with shower head, shower set and bathtub spout  
 Mitigeur à encastrer avec douche de tête, kit de douche et bec de baignoire  
 Miscelatore da incasso con soffione attacco, kit doccia e getto di vasca

13,7 l/min 2 bar 9,2 l/min 3 bar 14,5 l/min 3 bar

CON MANETA: / WITH LEVER: / AVEC LEVIER: / CON LEVA:

<b>SKY</b> 19SKYER31602	<b>LILE</b> 19LILER31602
<b>VENT-i2</b> 19VE2ER31602	<b>BETA</b> 19BETER31602

**ALL OUR CONCEALED SINGLE LEVER MIXERS INCLUDE:**  
 - Body mixer manufactured by hot brass stamping which assures a perfect seal of the pieces due to absence of porosities or cracks.  
 - Concealed box with bubble level to facilitate its installation as much as possible.  
 - Easy-access system for cartridge and diverter maintenance.

**TUTTI I NOSTRI MISCELATORI DA INCASSO INCLUDONO:**  
 - Corpo realizzato mediante stampaggio a caldo di ottone che garantisce una perfetta tenuta dello stesso grazie all'assenza di porosità o fessurazioni.  
 - Scatola da incasso con livella a bolla inclusa, che facilita notevolmente l'installazione del prodotto.  
 - Sistema di facile accesso per la manutenzione della cartuccia e dell'inverter.

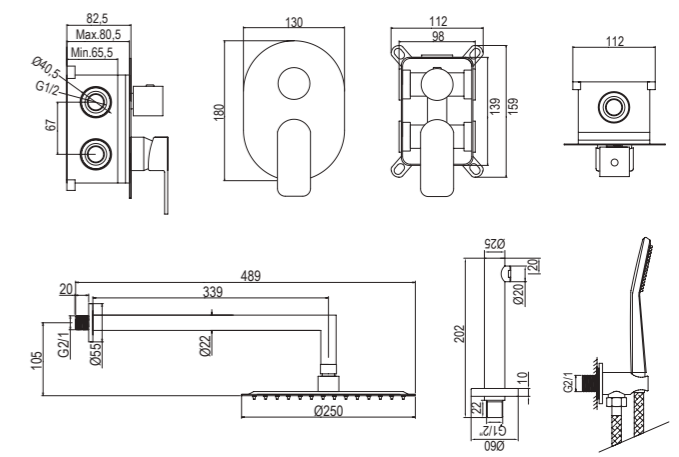



**GRIFERÍA TERMOSTÁTICA**  
**THERMOSTATIC MIXERS**  
**MITIGEURS THERMOSTATIQUES**  
**MISCELATORI TERMOSTATICI**



**Termostático de ducha con cartucho Citec**  
Shower thermostatic mixer with Citec cartridge  
Thermostatique de douche avec cartouche Citec  
Termostatico per doccia con cartuccia Citec

**Sin equipo / Without equipment**  
Sans équipement / Senza equipaggiamento

03ESC300CR

**Con equipo A / With equipment A**  
Avec équipement A / Con equipaggiamento A

03ESC302CR 12,5 l/min 3 bar

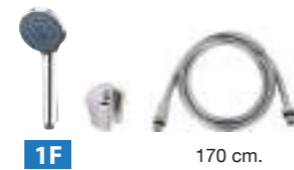
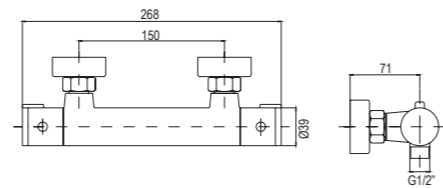

**Termostático para sistema de ducha, salida M 1/2" con cartucho Citec**  
Thermostatic mixer for shower system, outlet M 1/2" with Citec cartridge  
Thermostatique pour système de douche, salida M 1/2" avec cartouche Citec  
Termostatico per sistema doccia, uscita M 1/2" con cartuccia Citec

03ESC380CR

NEW

Disponible: Marzo 2022 / Available: March 2022  
Disponibile: Mars 2022 / Disponibile: Marzo 2022

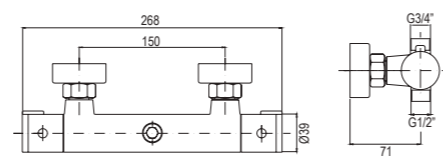

**Termostático para sistema de ducha con distribuidor incorporado y cartucho Citec**  
Thermostatic mixer for shower system with integrated distributor and Citec cartridge  
Thermostatique pour système de douche avec distributeur intégré et cartouche Citec  
Termostatico per sistema doccia con distributore integrato e cartuccia Citec

03ESC385CR

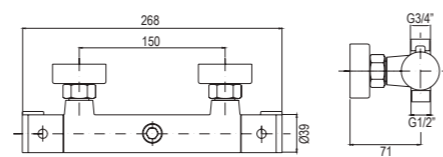

**Termostático de bañera con cartucho Citec**  
Bath thermostatic mixer with Citec cartridge  
Thermostatique de baignoire avec cartouche Citec  
Termostatico per vasca con cartuccia Citec

**Sin equipo / Without equipment**  
Sans équipement / Senza equipaggiamento

03ESC400CR 12,5 l/min 3 bar

**Con equipo A / With equipment A**  
Avec équipement A / Con equipaggiamento A

03ESC402CR 11,1 l/min 3 bar

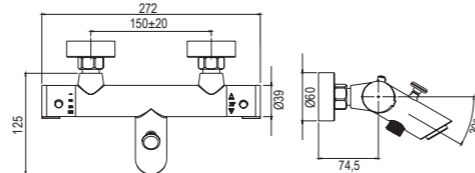

**Termostático para sistema de ducha con distribuidor incorporado y cartucho Citec**  
Thermostatic mixer for shower system with integrated distributor and Citec cartridge  
Thermostatique pour système de douche avec distributeur intégré et cartouche Citec  
Termostatico per sistema doccia con distributore integrato e cartuccia Citec

03ESC485CR 14,2 l/min 3 bar

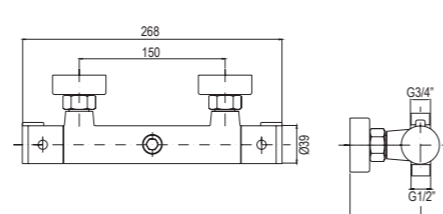

**gitec**



**CARTUCHO / CARTRIDGE**  
CARTOUCHE / CARTUCCIA



**CONTROL DE TEMPERATURA ESTABLE Y PRECISO**  
Temperatura preestablecida a 38 °C (100,4 °F)  
Regulación de temperatura de 15 °C a 60 °C (59 °F a 140 °F)

**SEGURIDAD, PROTECCIÓN ANTIQUEMADURAS**  
En caso de una falla en el suministro de agua fría, el flujo de agua se interrumpe inmediatamente.

**EXCELENTE CALIDAD**  
Conforme a norma europea EN-1111 y otros estándares internacionales.  
Fabricados con termoplásticos de última generación que los dota de una excepcional resistencia mecánica y a las altas temperaturas, además de una excelente estabilidad dimensional.  
Control individual de calidad. Pruebas de: temperatura preestablecida, caudal, control de fugas y control anti quemaduras efectuadas sobre el 100% de las unidades.

**CONTROLE DE TEMPÉRATURE STABLE ET PRÉCIS**  
Température prééglée à 38 °C (100,4 °F)  
Régulation de température de 15 °C à 60 °C (59 °F à 140 °F)

**SÉCURITÉ, PROTECTION ANTI-BRÛLURES**  
En cas de panne d'eau froide, le débit d'eau s'arrête immédiatement.

**EXCELLENTE QUALITÉ**  
Selon la norme européenne EN-1111 et d'autres normes internationales.  
Fabriqué avec des thermoplastiques avancés avec une résistance mécanique exceptionnelle, et aux hautes températures.  
Résistance et stabilité dimensionnelle.  
Contrôle de qualité individuel de 100% de la production, prééglage de la température, contrôle du débit, des fuites et de la protection anti-brûlures.

**STABLE AND PRECISE TEMPERATURE CONTROL**  
Preset temperature at 38 °C (100.4 °F)  
Temperature regulation from 15 °C to 60 °C (59 °F to 140 °F)

**SAFETY, ANTISCALD PROTECTION**  
In case of a cold water supply failure, water flow is interrupted immediately.

**EXCELLENT QUALITY**  
According to european norm EN-1111 and other international standards.  
Made with advanced thermoplastics with exceptional mechanical strength, high temp. Resistance and high temperatures, as well as, resistance and excellent dimensional stability.  
Individual quality control 100% of the production. Tests: temperature preset, flow rate, leakage monitoring and anti-scald protection performed on 100% of the units.

**CONTROLLO DELLA TEMPERATURA STABILE E PRECISO**  
Temperatura preimpostata a 38 °C (100,4 °F)  
Regolazione della temperatura da 15 °C a 60 °C (da 59 °F a 140 °F)

**SICUREZZA, PROTEZIONE DA USTIONI**  
In caso di guasto all'alimentazione dell'acqua fredda, il flusso dell'acqua viene immediatamente interrotto.

**QUALITÀ ECCELLENTE**  
In conformità con la norma europea EN-1111 e altre norme internazionali.  
Realizzati con materiali termoplastici di ultima generazione che forniscono loro un'eccezionale resistenza meccanica e alle alte temperature, oltre a un'eccellente stabilità dimensionale.  
Controllo qualità individuale. Prove di: controllo temperatura, portata, perdite e antiscottatura prestabilite effettuate sul 100% delle unità.

**FÁCIL LIMPIEZA**  
EASY CLEAN  
NETTOYAGE FACILE  
FACILE PULIZIA



Solo disponible para la serie Escade  
Only available for Escade serie  
Uniquement disponible pour la série Escade  
Disponibile solo per la serie Escade

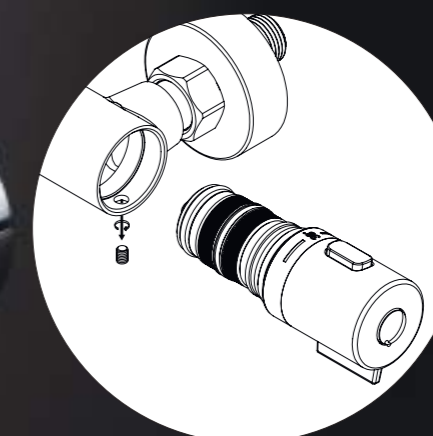

Fácil mantenimiento del cartucho gracias a su sistema de rápido desmontaje y montaje

Easy maintenance of the cartridge thanks to its quick system of assembly and disassembly

Facile maintenance de la cartouche grâce à son système de démontage et d'assemblage rapide

Facile manutenzione della cartuccia grazie al suo sistema di smontaggio e di assemblaggio rapido



**Termostático de ducha**  
Shower thermostatic mixer  
Thermostatique de douche  
Termostatico per doccia

**Sin equipo / Without equipment**  
Sans équipement / Senza equipaggiamento

03SIG300CR

**Con equipo A / With equipment A**  
Avec équipement A / Con equipaggiamento A

03SIG302CR 12 l/min 3 bar

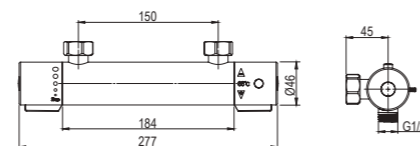

1F 170 cm.



**Termostático para sistema de ducha con distribuidor incorporado**  
Thermostatic mixer for shower system with integrated distributor  
Thermostatique pour système de douche avec distributeur intégré  
Termostatico per sistema doccia con distributore integrato

03SIG385CR

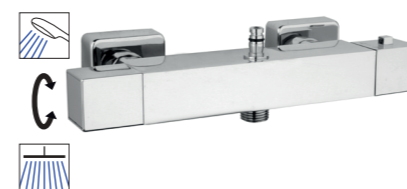
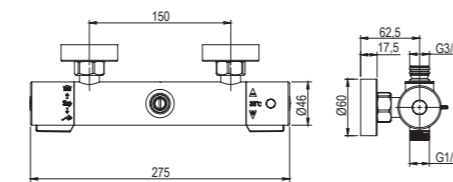

**Termostático para sistema de ducha con distribuidor incorporado**  
Thermostatic mixer for shower system with integrated distributor  
Thermostatique pour système de douche avec distributeur intégré  
Termostatico per sistema doccia con distributore integrato

03QUA485CR



**Termostático de ducha con cartucho Citec**  
Shower thermostatic mixer with Citec cartridge  
Thermostatique de douche avec cartouche Citec  
Termostatico per doccia con cartuccia Citec

**Sin equipo / Without equipment**  
Sans équipement / Senza equipaggiamento

03QUA300CR

**Con equipo U / With equipment U**  
Avec équipement U / Con equipaggiamento U

03QUA322CR 12,9 l/min 3 bar

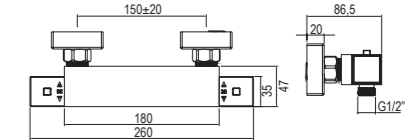

1F 170 cm.



**Termostático para sistema de ducha, salida M 1/2" con cartucho Citec**  
Thermostatic mixer for shower system, outlet M 1/2" with Citec cartridge  
Thermostatique pour système de douche, salida M 1/2" avec cartouche Citec  
Termostatico per sistema doccia, uscita M 1/2" con cartuccia Citec

03QUA380CR

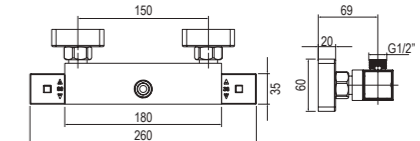

**Termostático de bañera con cartucho Citec**  
Bath thermostatic mixer with Citec cartridge  
Thermostatique de baignoire avec cartouche Citec  
Termostatico per vasca con cartuccia Citec

**Sin equipo / Without equipment**  
Sans équipement / Senza equipaggiamento

03QUA400CR 15,0 l/min 3 bar

**Con equipo U / With equipment U**  
Avec équipement U / Con equipaggiamento U

03QUA422CR 11,6 l/min 3 bar

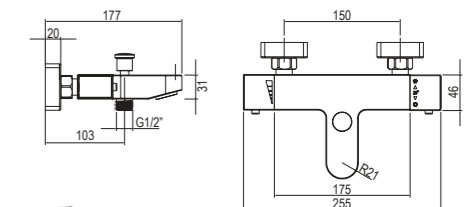

1F 170 cm.



**GRIFERÍA DE SUELO PARA BAÑERA**  
**FREESTANDING BATHTUBS**  
**GRIFERÍA SUR PIED POUR BAIGNOIRE**  
**RUBINETTERIA A PAVIMENTO PER VASCA**



Disponible: Mayo 2022 / Available: May 2022  
Disponibile: Mai 2022 / Disponibile: Maggio 2022



1F

### MINIMALISTA

- Grifo monomando de suelo para bañera y ducha
- Con conexión empotrada incluida
- Mango de ducha de ABS
- Flexo de acero inoxidable
- Soporte de ducha
- Derivador integrado

- Single lever freestanding bathtub
- Concealed connection included
- ABS shower hand
- Inox stainless steel flexible
- Shower bracket
- Integrated diverter

- Mitigeur sur pied pour baignoire et douche
- Avec connexion encastrée incluse
- Douchette ABS
- Flexible en acier inoxydable
- Support pour douchette
- Dérivateur intégré

- Miscelatore a pavimento per vasca e doccia
- Con connessione integrata inclusa.
- Doccetta in ABS
- Flessibile in acciaio inossidabile
- Supporto per doccetta
- Deviatore integrato

01MIN601CR 15 l/min 3 bar

NEW



11,2 l/min 3 bar

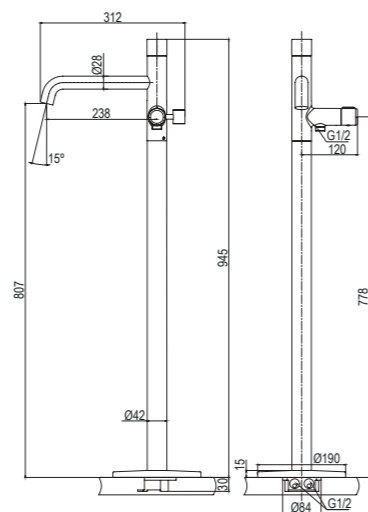

1F

### MINIMALISTA

- Grifo monomando de suelo para bañera y ducha
- Con conexión empotrada incluida
- Mango de ducha de ABS
- Flexo de acero inoxidable
- Soporte de ducha
- Derivador integrado

- Single lever freestanding bathtub
- Concealed connection included
- ABS shower hand
- Inox stainless steel flexible
- Shower bracket
- Integrated diverter

- Mitigeur sur pied pour baignoire et douche
- Avec connexion encastrée incluse
- Douchette ABS
- Flexible en acier inoxydable
- Support pour douchette
- Dérivateur intégré

- Miscelatore a pavimento per vasca e doccia
- Con connessione integrata inclusa.
- Doccetta in ABS
- Flessibile in acciaio inossidabile
- Supporto per doccetta
- Deviatore integrato

01MIN601NG 15 l/min 3 bar

NEW



11,2 l/min 3 bar

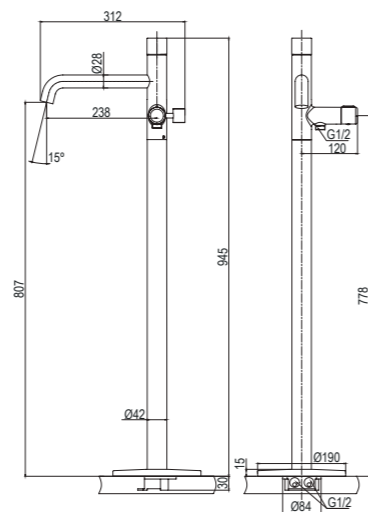

**GRIFERÍA DE SUELO PARA BAÑERA**  
**FREESTANDING BATHTUBS**  
**ROBINETTERIE SUR PIED POUR BAIGNOIRE**  
**RUBINETTERIA A PAVIMENTO PER VASCA**

Disponibile: Mayo 2022 / Available: May 2022  
Disponibile: Mai 2022 / Disponibile: Maggio 2022



**BOLD**

- Grifo monomando de suelo para bañera y ducha
- Con conexión empotrada incluida
- Mango de ducha de ABS
- Flexo de acero inoxidable
- Soporte de ducha
- Derivador integrado

- Single lever freestanding bathtub
- Concealed connection included
- ABS shower hand
- Inox stainless steel flexible
- Shower bracket
- Integrated diverter

- Mitigeur sur pied pour baignoire et douche
- Avec connexion encastrée incluse
- Douchette ABS
- Flexible en acier inoxydable
- Support pour douchette
- Dérivateur intégré

- Miscelatore a pavimento per vasca e doccia
- Con connessione integrata inclusa.
- Doccetta in ABS
- Flessibile in acciaio inossidabile
- Supporto per doccetta
- Deviatore integrato

01BOL602CR 14,5 l/min 3 bar

NEW

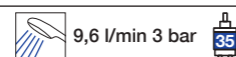



**COLUMNAS DE HIDROMASAJE**  
**SHOWER COLUMNS**  
**COLONNES DE DOUCHE**  
**COLONNE DOCCIA**

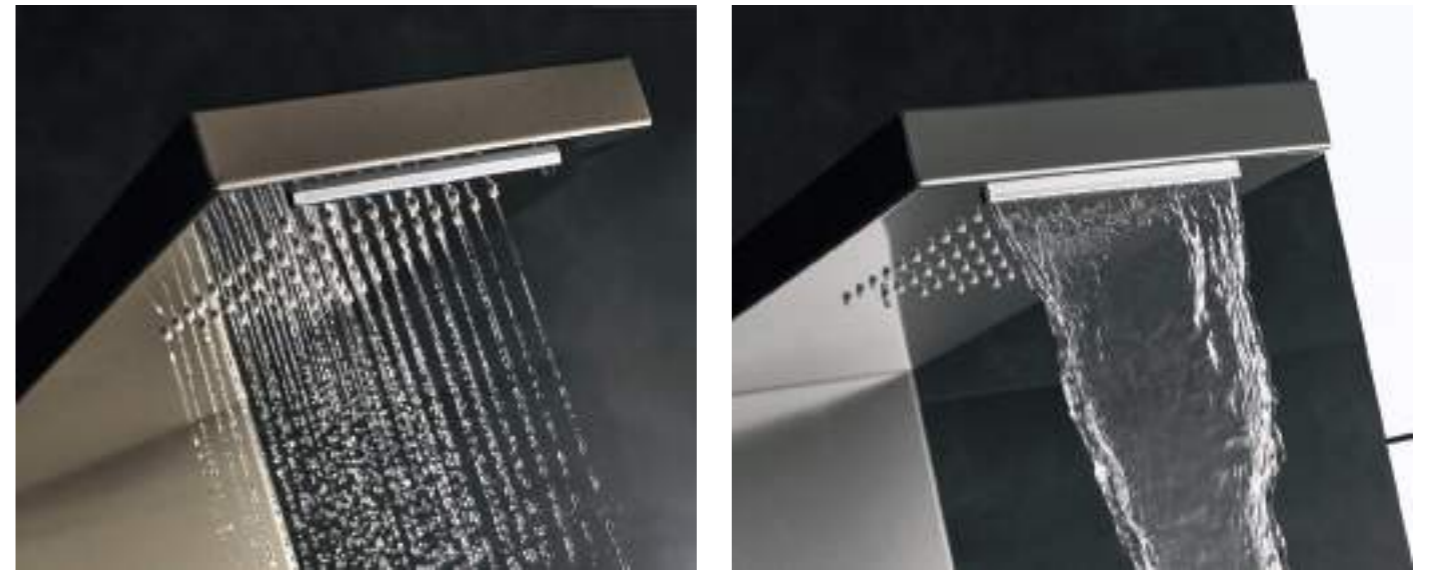

**Columna con grifería monomando**  
Column with single lever mixer  
Colonne avec mitigeur  
Colonna con miscelatore

18EDN01IS



**Columna con grifería termostática**  
Column with thermostatic mixer  
Colonne avec thermostatique  
Colonna con termostatico

18EDN05IS

**CARACTERÍSTICAS:**

- Presión mínima: 0,8 bar, presión máxima: 5 bar
- Presión recomendada de funcionamiento: de 1,5 a 3 bar
- Columna en acero inoxidable AISI 304 con tratamiento antihuellas
- 3 años de garantía
- 4 funciones: mango de ducha, rociador, cascada y jets de masaje horizontal
- Jets y mango de ducha anticalcáreos
- Flexo de ducha de acero inoxidable, doble grapado de 150 cm

**CATACTÉRISTIQUES:**

- Pression minimale: 0,8 bar, pression maximale: 5 bar
- Pression recommandée de fonctionnement: de 1,5 à 3 bar
- Colonne en acier inoxydable aisi 304 avec traitement antitraçage
- 3 ans de garantie
- 4 fonctions disponibles: douchette, douche de tête, cascade et jets de massage horizontaux
- Jets et pomme haute anticalcaires
- Flexible en acier inox, double agrafage, 150 cm.

**CHARACTERISTICS:**

- Minimum pressure: 0,8 bar, maximum pressure: 5 bar
- Recommended operating pressure: from 1,5 to 3 bar
- Stainless steel AISI 304 column with anti-fingerprint treatment
- 3 year guarantee
- 4 functions: hand shower, shower head, waterfall and horizontal jets massage
- Antiscaling jets and shower head
- Stainless steel flexible hose, double hooked, 150 cm

**CHARATERISTICHE:**

- Pressione minima: 0,8 bar, pressione massima: 5 bar
- Pressione d'esercizio consigliata: da 1,5 a 3 bar
- Colonna in acciaio inox Aisi 304 con trattamento antitraccia
- 3 anni di garanzia
- 4 funzione disponibili: doccetta, soffione, cascata e getti di massaggio orizzontali
- Getti doccia e maniglia anticalcare
- Tubo in acciaio inossidabile, doppia aggiratura, 150 cm.

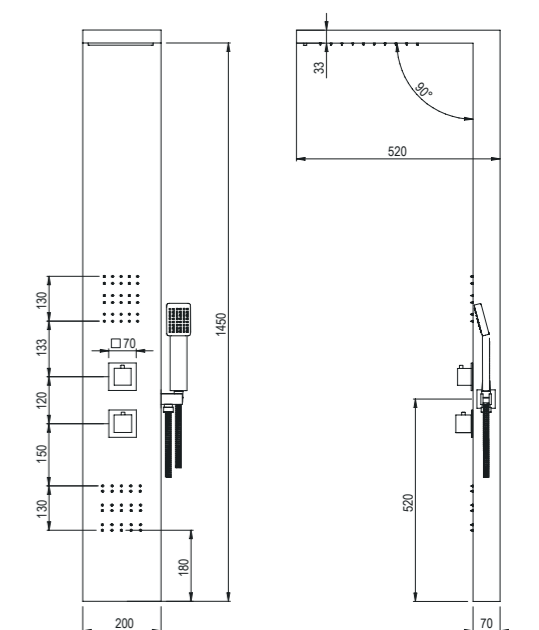



**Columna con grifería monomando**  
Column with single lever mixer  
Colonne avec mitigeur  
Colonna con miscelatore

18ONN01IS



**Columna con grifería termostática**  
Column with thermostatic mixer  
Colonne avec thermostatique  
Colonna con termostatico

18ONN05IS

**CARACTERÍSTICAS:**

- Presión mínima: 0,8 bar, presión máxima: 5 bar
- Presión recomendada de funcionamiento: de 1,5 a 3 bar
- Columna en acero inoxidable AISI 304 con tratamiento antihuellas
- 3 años de garantía
- 3 funciones: mango de ducha, rociador y jets de masaje horizontal
- Jets y mango de ducha anticalcáreos
- Flexo de ducha de acero inoxidable, doble grapado de 150 cm

**CATACÉRISTIQVES:**

- Pression minimale: 0,8 bar, pression maximale: 5 bar
- Pression recommandée de fonctionnement: de 1,5 à 3 bar
- Colonne en acier inoxydable aisi 304 avec traitement antitraçage
- 3 ans de garantie
- 3 fonctions disponibles: douchette, douche de tête et jets de massage horizontaux
- Jets et pomme haute anticalcaires
- Flexible en acier inox, double agrafage, 150 cm.

**CHARACTERISTICS:**

- Minimum pressure: 0,8 bar, maximum pressure: 5 bar
- Recommended operating pressure: from 1,5 to 3 bar
- Stainless steel AISI 304 column with anti-fingerprints treatment
- 3 year guarantee
- 3 functions: shower head, rain head and horizontal jet massage
- Antiscaling jets and shower head
- Stainless steel flexible hose, double hooked, 150 cm

**CHARACTERISTICHE:**

- Pressione minima: 0,8 bar, pressione massima: 5 bar
- Pressione d'esercizio consigliata: da 1,5 a 3 bar
- Colonna in acciaio inox Aisi 304 con trattamento antitraccia
- 3 anni di garanzia
- 3 funzione disponibili: doccia, soffione e getti di massaggio orizzontali
- Getti doccia e maniglia anticalcare
- Tubo in acciaio inossidabile, doppia aggraffatura, 150 cm.

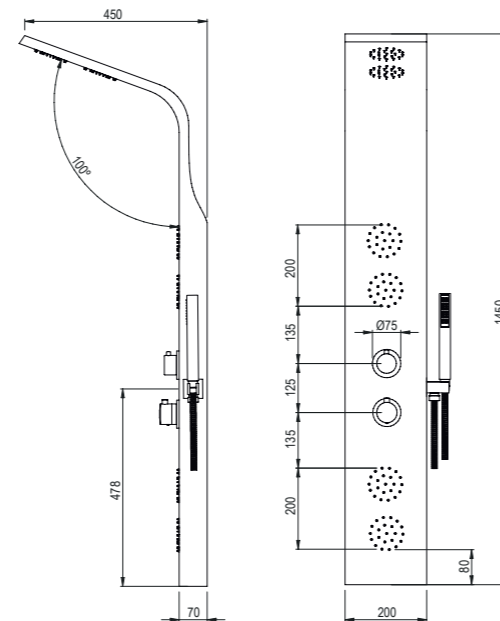



**Columna con grifería monomando**  
Column with single lever mixer  
Colonne avec mitigeur  
Colonna con miscelatore

18RIO01AL



**Columna con grifería termostática**  
Column with thermostatic mixer  
Colonne avec thermostatique  
Colonna con termostatico

18RIO05AL

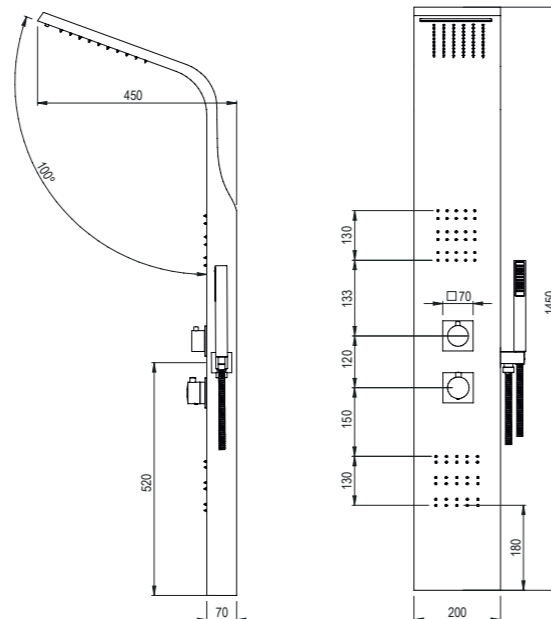

**CARACTERÍSTICAS:**

- Presión mínima: 0,8 bar, presión máxima: 5 bar
- Presión recomendada de funcionamiento: de 1,5 a 3 bar
- Columna en aluminio barnizado con tratamiento antihuellas
- 3 años de garantía
- 4 funciones: mango de ducha, rociador, cascada y jets de masaje horizontal
- Jets y mango de ducha anticalcáreos
- Flexo de ducha de acero inoxidable, doble grapado de 150 cm

**CATACTÉRISTIQUES:**

- Pression minimale: 0,8 bar, pression maximale: 5 bar
- Pression recommandée de fonctionnement: de 1,5 à 3 bar
- Colonne en aluminium vernissé avec traitement antitraçage
- 3 ans de garantie
- 4 fonctions disponibles: douchette, douche de tête effet cascade, jets de massage horizontaux
- Jets et pomme haute anticalcaires
- Flexible en acier inox, double agrafage, 150 cm.

**CHARACTERISTICS:**

- Minimum pressure: 0,8 bar, maximum pressure: 5 bar
- Recommended operating pressure: from 1,5 to 3 bar
- Varnished aluminium column with non-marking treatment
- 3 year guarantee
- 4 functions: hand shower, shower head, waterfall and horizontal jets massage
- Antiscaling jets and shower head
- Stainless steel flexible hose, double hooked, 150 cm

**CARATERISTICHE:**

- Pressione minima: 0,8 bar, pressione massima: 5 bar
- Pressione d'esercizio consigliata: da 1,5 a 3 bar
- Colonna in alluminio verniciato con trattamento antitraçcia
- 3 anni di garanzia
- 4 funzione disponibili: doccetta, soffione, cascata e getti di massaggio orizzontali
- Getti doccia e maniglia anticalcare
- Tubo in acciaio inossidabile, doppia aggiratura, 150 cm.

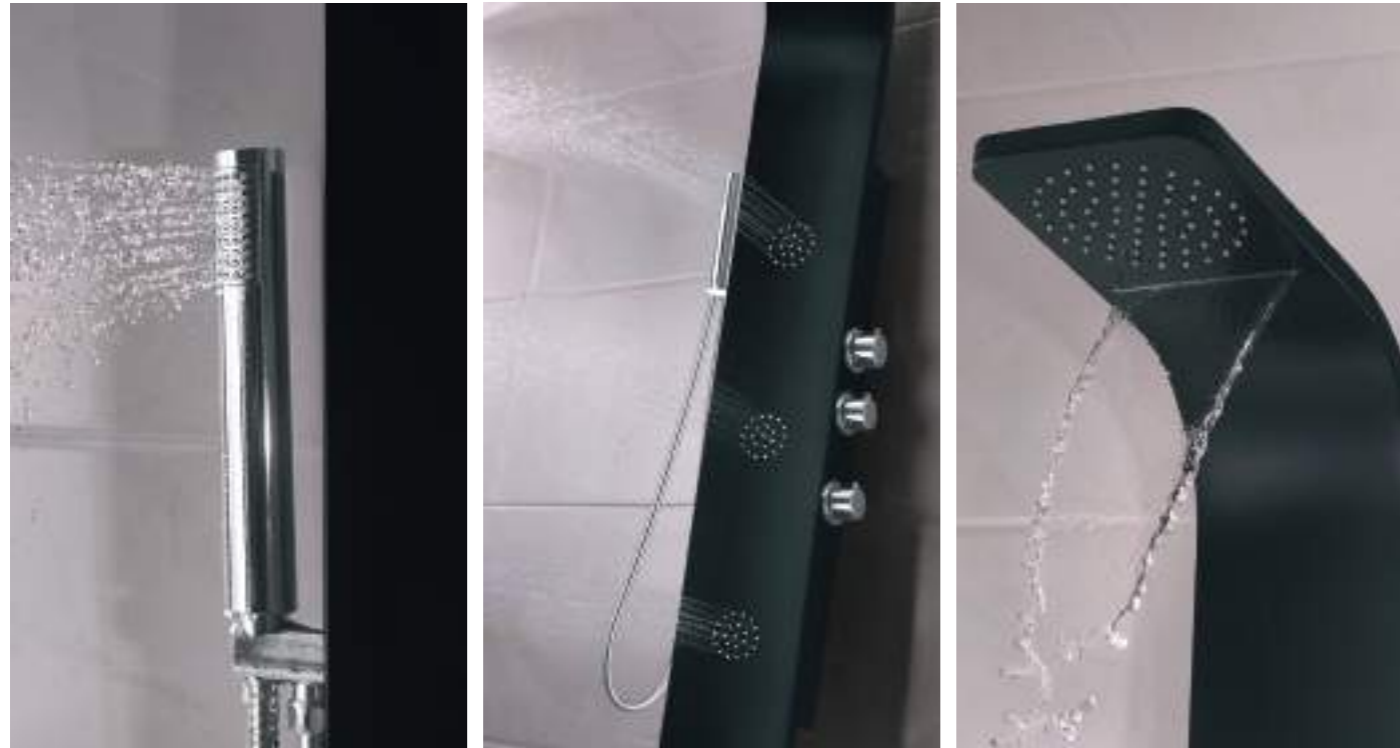

**Columna con grifería monomando**  
Column with single lever mixer  
Colonne avec mitigeur  
Colonna con miscelatore

18NOI01NG



**Columna con grifería termostática**  
Column with thermostatic mixer  
Colonne avec thermostatique  
Colonna con termostatico

18NOI05NG

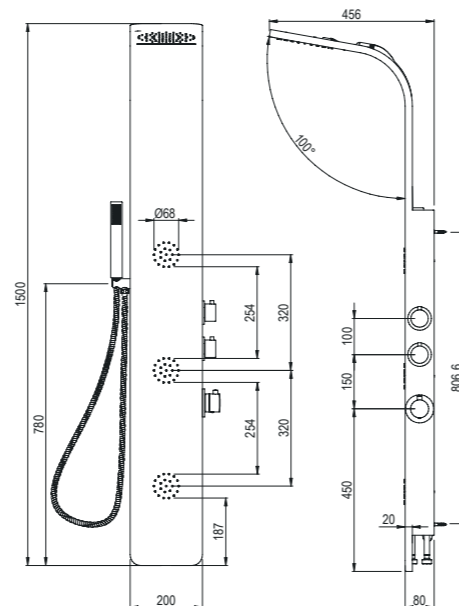

**CARACTERÍSTICAS:**

- Presión mínima: 1,5 bar, presión máxima: 6 bar
- Presión recomendada de funcionamiento: de 1,5 a 3 bar
- Columna en aluminio con revestimiento en negro mate
- 3 años de garantía
- 4 funciones: mango de ducha, rociador, cascada y jets de masaje horizontal
- Jets y mango de ducha anticalcáreos
- Flexo de ducha de acero inoxidable, doble grapado de 150 cm

**CATACTÉRISTIQUES:**

- Pression minimale: 1,5 bar, pression maximale: 6 bar
- Pression recommandée de fonctionnement: de 1,5 à 3 bar
- Colonne en aluminium avec revêtement noir mat
- 3 ans de garantie
- 4 fonctions disponibles: douchette, douche de tête, cascade et jets de massage horizontal
- Jets et pomme haute anticalkaires
- Flexible en acier inox, double agrafage, 150 cm.

**CHARACTERISTICS:**

- Minimum pressure: 1,5 bar, maximum pressure: 6 bar
- Recommended operating pressure: from 1,5 to 3 bar
- Aluminium column with black matt coating
- 3 year guarantee
- 4 functions: shower head, rain head, waterfall and horizontal jet massage
- Antiscaling jets and shower head
- Stainless steel flexible hose, double hooked, 150 cm

**CHARATERISTICHE:**

- Pressione minima: 1,5 bar, pressione massima: 6 bar
- Pressione d'esercizio consigliata: da 1,5 a 3 bar
- Colonna in alluminio con rivestimento nero opaco
- 3 anni di garanzia
- 4 funzioni disponibili: doccia, soffione, cascata e getti di massaggio orizzontali
- Getti doccia e maniglia anticalcare
- Tubo in acciaio inossidabile, doppia aggraffatura, 150 cm.



NOIR con grifería monomando / NOIR with single lever mixer  
NOIR avec mitigeur / NOIR con miscelatore

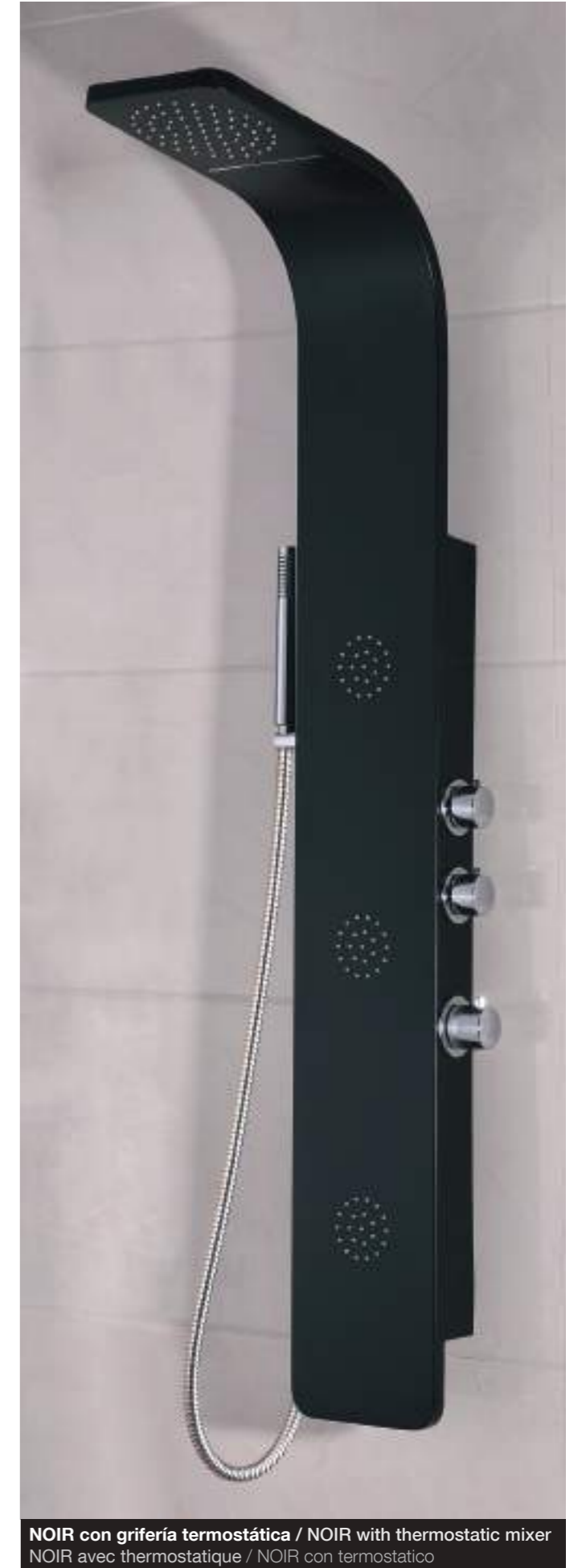

NOIR con grifería termostática / NOIR with thermostatic mixer  
NOIR avec thermostatique / NOIR con termostatico



**PROGRAMA DE DUCHA**  
**SHOWER PROGRAMME**  
**PROGRAMME DE DOUCHE**  
**PROGRAMMA DI DOCCIA**

PROGRAMA DE DUCHA  
SHOWER PROGRAMME



**FLOW R1**

**Rociador función lluvia, acabado pulido espejo**  
Rain function shower head, mirror-polished finish  
Douche de tête fonction pluie, avec finition poli miroir  
Soffione funzione pioggia, con finitura lucida a specchio  
**8,3 l/min Clase Z \***

caja / box  
boîte / scatola **19FLO0220R1F**

**Z class**  
8,3 l/min **1F**

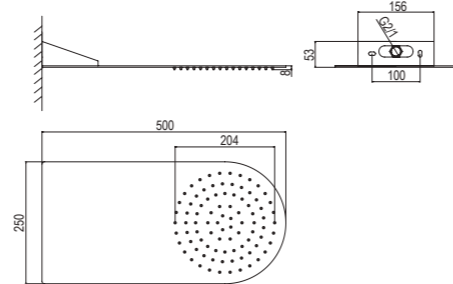

**FLOW R2**

**Rociador de dos funciones, cascada y lluvia, acabado pulido espejo**  
2 functions shower head, waterfall and rain, mirror-polished finish  
Douche de tête 2 fonctions, cascade et pluie, avec finition poli miroir  
Soffione 2 funzioni, cascata e pioggia, con finitura lucida a specchio  
**8,3 l/min Clase Z \***

caja / box  
boîte / scatola **19FLO0220R2F**

**Z class**  
8,3 l/min **2F**

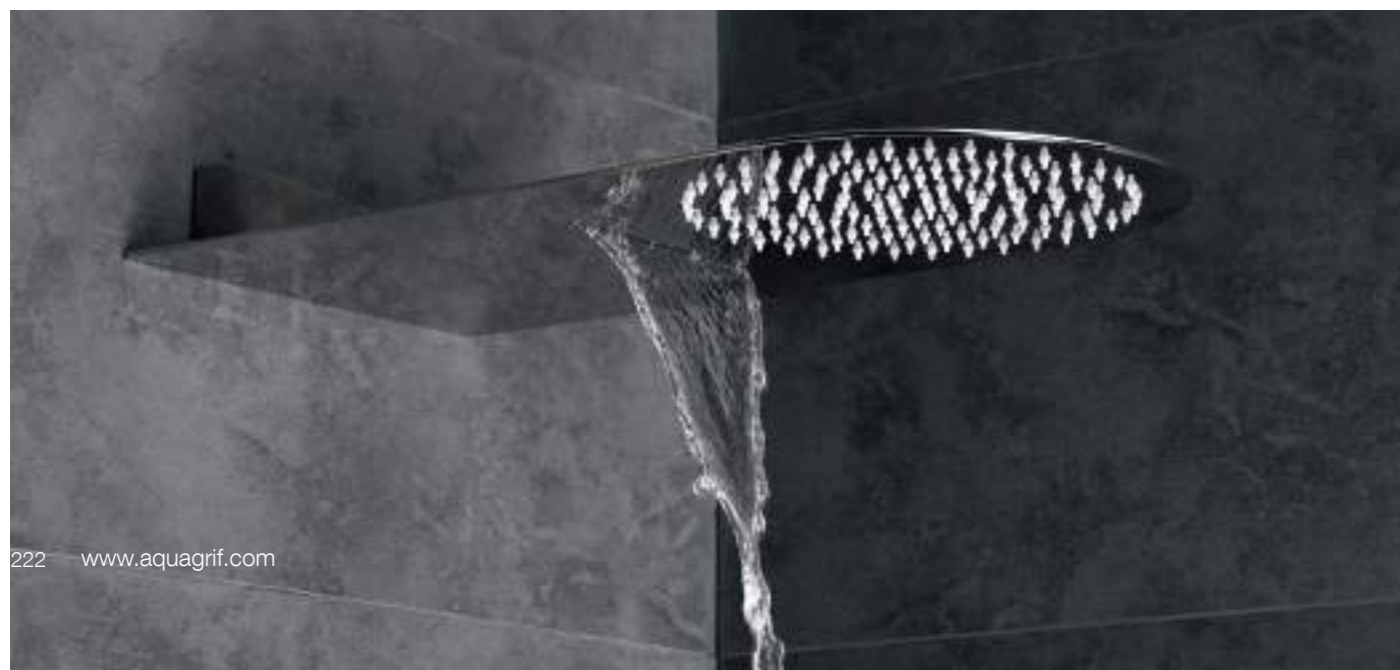
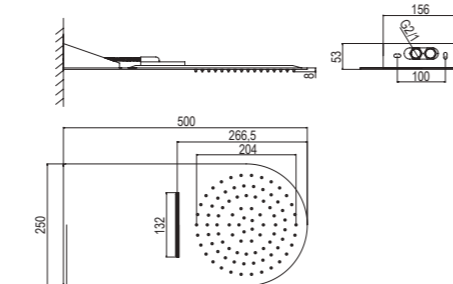

**FLOW C1**

**Rociador función lluvia, acabado pulido espejo**  
Rain function shower head, mirror-polished finish  
Douche de tête fonction pluie, avec finition poli miroir  
Soffione funzione pioggia, con finitura lucida a specchio  
**20,8 l/min Clase Z \***

caja / box  
boîte / scatola **19FLO0220C1F**

**B class**  
20,8 l/min **1F**

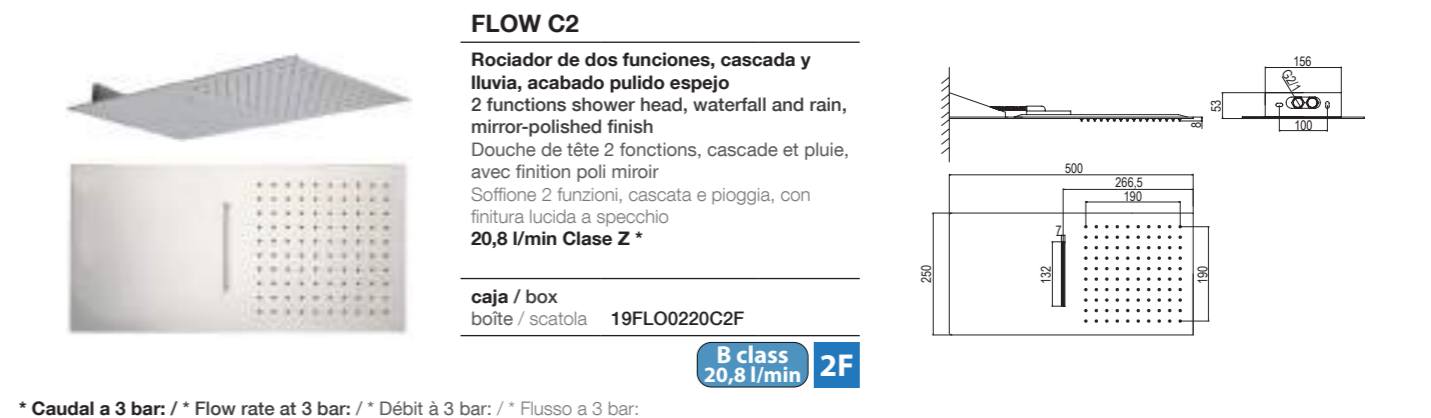
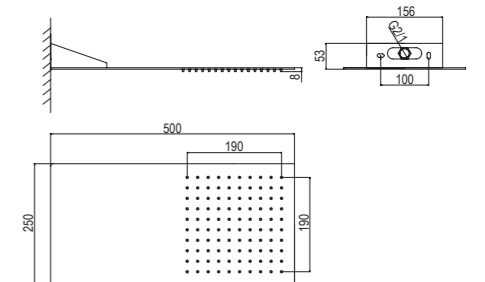

**FLOW C2**

**Rociador de dos funciones, cascada y lluvia, acabado pulido espejo**  
2 functions shower head, waterfall and rain, mirror-polished finish  
Douche de tête 2 fonctions, cascade et pluie, avec finition poli miroir  
Soffione 2 funzioni, cascata e pioggia, con finitura lucida a specchio  
**20,8 l/min Clase Z \***

caja / box  
boîte / scatola **19FLO0220C2F**

**B class**  
20,8 l/min **2F**

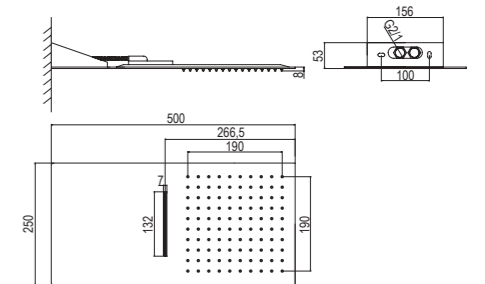

\* Caudal a 3 bar: / \* Flow rate at 3 bar: / \* Débit à 3 bar: / \* Flusso a 3 bar:



**ATLAS C25**  
Rociador / Shower head / Douche de tête / Soffione



**ATLAS R25**  
Rociador / Shower head / Douche de tête / Soffione

**ATLAS**

Rociador orientable, anticalcáreo, de acero inoxidable AISI 304 acabado pulido espejo  
Adjustable shower head, antiscaling, in stainless steel AISI304 mirror-polished finish  
Douche de tête orientable, anticalcaire, en acier inoxydable AISI 304 finition poli miroir  
Soffione regolabile, anticalcare, in acciaio inossidabile AISI 304 con finitura lucida a specchio



**ATLAS C20** 23,3 l/min B class \*

caja / box  
boîte / scatola 11ATL0220C20

20 x 20 cm

20 x 20 cm

B class 23,3 l/min 1F

**ATLAS R20** 24,2 l/min B class \*

caja / box  
boîte / scatola 11ATL0220R20

Ø 20 cm

Ø 20 cm

B class 24,2 l/min 1F

**ATLAS C25** 24,2 l/min B class \*

caja / box  
boîte / scatola 11ATL0220C25

25 x 25 cm

25 x 25 cm

B class 24,2 l/min 1F

**ATLAS R25** 21,7 l/min B class \*

caja / box  
boîte / scatola 11ATL0220R25

Ø 25 cm

Ø 25 cm

B class 21,7 l/min 1F

**ATLAS C30** 24,3 l/min B class \*

caja / box  
boîte / scatola 11ATL0220C30

30 x 30 cm

30 x 30 cm

B class 24,3 l/min 1F

**ATLAS R30** 25,0 l/min B class \*

caja / box  
boîte / scatola 11ATL0220R30

Ø 30 cm

Ø 30 cm

B class 25,0 l/min 1F

**ATLAS C40** 24,2 l/min B class \*

caja / box  
boîte / scatola 11ATL0220C40

40 x 40 cm

40 x 40 cm

B class 24,2 l/min 1F

**ATLAS R40** 23,3 l/min B class \*

caja / box  
boîte / scatola 11ATL0220R40

Ø 40 cm

Ø 40 cm

B class 23,3 l/min 1F



**ATLAS C20**  
Rociador / Shower head / Douche de tête / Soffione

### GREGAL

Rociador orientable, anticálcero  
Adjustable shower head, antiscaling  
Douche de tête orientable, anticalcaire  
Soffione regolabile, anticalcare  
21,8 l/min B class \*  
20 x 20 cm



caja / box  
boîte / scatola 11GRE0125

blister / blister  
blister / blister 11GRE0140

20 x 20  
B class  
21,8 l/min 1F



GREGAL  
Rociador / Shower head / Douche de tête / Soffione

### WIND BLU RD

Rociador orientable, anticálcero  
Adjustable shower head, antiscaling  
Douche de tête orientable, anticalcaire  
Soffione regolabile, anticalcare  
20,0 l/min B class \*  
Ø 24 cm



caja / box  
boîte / scatola 11WBL0120R24

Ø 23,5  
B class  
20,0 l/min 1F



### WIND BLU SQ

Rociador orientable, anticálcero  
Adjustable shower head, antiscaling  
Douche de tête orientable, anticalcaire  
Soffione regolabile, anticalcare  
24,2 l/min B class \*  
22,5 x 22,5 cm

caja / box  
boîte / scatola 11WBL0120C22

22,5 x 22,5  
B class  
24,2 l/min 1F

\* Caudal a 3 bar: / \* Flow rate at 3 bar: / \* Débit à 3 bar: / \* Flusso a 3 bar:



WIND BLU RD  
Rociador / Shower head / Douche de tête / Soffione



DARA  
Rociador / Shower head / Douche de tête / Soffione

### GLACIAR

Rociador orientable, anticálcero  
Adjustable shower head, antiscaling  
Douche de tête orientable, anticalcaire  
Soffione regolabile, anticalcare  
25,8 l/min C class \*  
Ø 20 cm



caja / box  
boîte / scatola 11GLA0120

blister / blister  
blister / blister 11GLA0140

Ø 20  
C class  
25,8 l/min 1F

### 811

Rociador orientable de 8 funciones,  
anticálcero  
Adjustable shower head 8 functions,  
antiscaling  
Douche de tête orientable, 8 fonctions,  
anticalcaire  
Soffione regolabile, 8 funzioni, anticalcare  
9,2 l/min Clase Z \*  
Ø 10 cm



caja / box  
boîte / scatola 118110120

Ø 10  
Z class  
9,2 l/min 8F

### DARA

Rociador orientable, anticálcero  
Adjustable shower head, antiscaling  
Douche de tête orientable, anticalcaire  
Soffione regolabile, anticalcare  
25,8 l/min C class \*  
Ø 20 cm



caja / box  
boîte / scatola 11DAR0125

blister / blister  
blister / blister 11DAR0140

Ø 20  
C class  
25,8 l/min 1F

### 112

Rociador orientable, anticálcero  
Adjustable shower head, antiscaling  
Douche de tête orientable, anticalcaire  
Soffione regolabile, anticalcare  
20,0 l/min B class \*  
Ø 8,5 cm



granel / bulk  
en vrac / sfuso 111120100

Ø 8,5  
B class  
20,0 l/min 1F

\* Caudal a 3 bar: / \* Flow rate at 3 bar: / \* Débit à 3 bar: / \* Flusso a 3 bar:

### STILUS

**Brazo de pared cuadrado de latón cromado**  
Square wall shower arm in chromed brass  
Bras de douche à fixer carré en laiton chromé  
Braccio a muro quadrato in ottone cromato

caja / box  
boîte / scatola 12STI0120

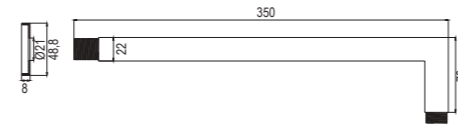

### CURVE

**Brazo de pared de acero inoxidable AISI 304 cromado**  
Wall shower arm, chromed in stainless steel AISI 304  
Bras de douche à fixer en acier inoxydable AISI 304 chromé  
Braccio a muro, in acciaio inossidabile AISI 304 cromato

caja / box  
boîte / scatola 12CUR0120

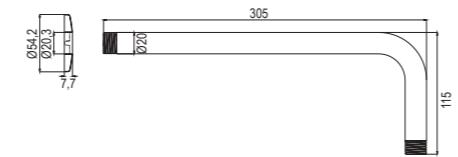

### VARY

**Brazo de pared de acero inoxidable AISI 304 cromado, de 37,5 cm**  
Wall shower arm, chromed in stainless steel AISI 304, 37.5 cm length  
Bras de douche à fixer en acier inoxydable AISI 304 chromé, de 37,5 cm  
Braccio a muro, in acciaio inossidabile AISI 304 cromato, 37.5 cm

caja / box  
boîte / scatola 12VAR0120

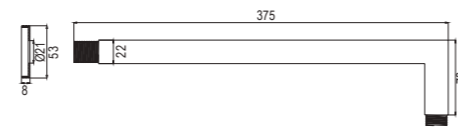

### SLIM

**Brazo de pared de latón cromado, de 43 cm**  
Wall shower arm, chromed in brass, 43 cm length  
Bras de douche à fixer en laiton chromé, de 43 cm  
Braccio a muro in ottone cromato, 43 cm

caja / box  
boîte / scatola 12SLI0125

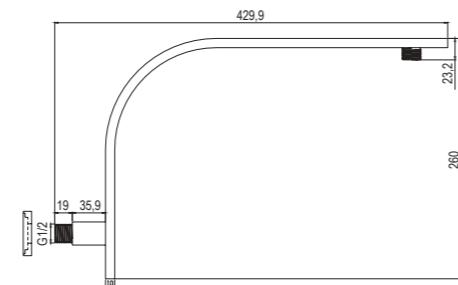

### CURL

**Brazo de pared corto de acero inoxidable AISI 304 cromado**  
Short wall shower arm, chromed in stainless steel AISI 304  
Bras de douche à fixer court en acier inoxydable AISI 304 chromé  
Braccio a muro corto in acciaio inossidabile AISI 304 cromato

caja / box  
boîte / scatola 12CUL0120

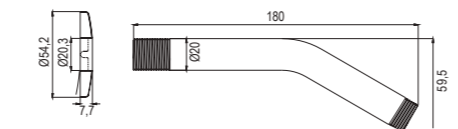

### FARO

**Brazo de pared de acero inoxidable AISI 304 cromado**  
Wall shower arm, chromed in stainless steel AISI 304  
Bras de douche à fixer en acier inoxydable AISI 304 chromé  
Braccio a muro, in acciaio inossidabile AISI 304 cromato

caja / box  
boîte / scatola 12FAR0120

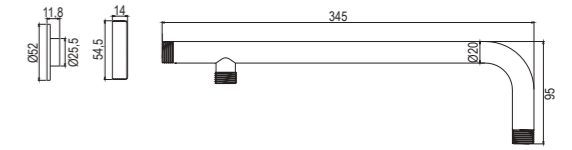

### STYLO

**Brazo de techo de latón cromado, de 20 cm**  
Ceiling shower arm, chromed in brass, 20 cm length  
Bras au plafond en laiton chromé, de 20 cm  
Braccio a soffitto, in ottone cromato, 20 cm

caja / box  
boîte / scatola 12STY0120

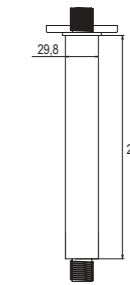

### TUVE

**Brazo de techo de acero inoxidable AISI 304 cromado, de 20 cm**  
Ceiling shower arm, chromed in stainless steel AISI 304, 20 cm length  
Bras au plafond en acier inoxydable AISI 304 chromé, de 20 cm  
Braccio a soffitto, in acciaio inossidabile AISI 304 cromato, 20 cm

caja / box  
boîte / scatola 12TUV0120

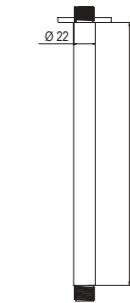

### CAÑO DE EMPOTRAR PARA BAÑERA / CONCEALED BATHTUB SPOUT BEC À ENCASTRER POUR BAIGNOIRE / GETTO DA INCASO PER VASCA

### ROLL

**Caño de bañera de latón cromado**  
Concealed bathtub spout in chromed brass  
Bec à encastrer en laiton chromé  
Getto da incasso in ottone cromato

caja / box  
boîte / scatola 19ROL0225 13,7 l/min 3 bar

**NEW**  
Disponible: Mayo 2022 / Available: May 2022  
Disponibile: Mai 2022 / Disponibile: Maggio 2022

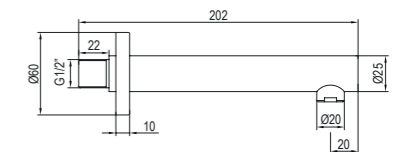

### ROC

**Caño de bañera de latón cromado**  
Concealed bathtub spout in chromed brass  
Bec à encastrer en laiton chromé  
Getto da incasso in ottone cromato

caja / box  
boîte / scatola 19ROC0225 22,6 l/min 3 bar

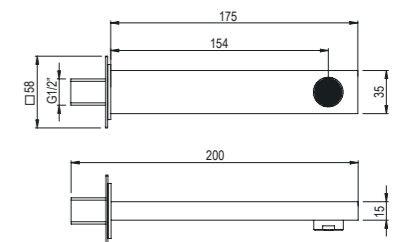

### SLIM

Ducha de 1 función de latón, anticalcárea  
1 function hand shower, in brass,  
antiscaling  
Douchette 1 fonction en laiton, anticalcaire  
Doccetta a 1 funzione in ottone, anticalcare  
**12,5 l/min A class \***  
**35 x 76 mm**

granel / bulk  
en vrac / sfuso 10SLI0100

bolsa / bag  
sachet / busta 10SLI0110

blister / blister  
blister / blister 10SLI0140

caja / box  
boîte / scatola 10SLI0120

35  
x  
76  
A class  
12,5 l/min  
1F



### NITE RD

Ducha de 3 funciones anticalcárea con  
botón para cambiar de función  
3 functions hand shower with button to  
change function, antiscaling  
Douchette 3 fonctions avec bouton pour  
changer les positions, anticalcaire  
Doccetta a 3 funzioni con pulsante per  
cambiare le posizioni, anticalcare  
**10,4 l/min Z class \***  
**Ø 120 mm**

granel / bulk  
en vrac / sfuso 10NIR0100

blister / blister  
blister / blister 10NIR0140

caja / box  
boîte / scatola 10NIR0120

Ø  
120  
Z class  
10,4 l/min  
3F



### AZALEA

Ducha de 5 funciones con función stop,  
anticalcárea  
Hand shower 5 functions with stop mode,  
antiscaling  
Douchette 5 fonctions avec fonction stop,  
anticalcaire  
Doccetta a 5 funzioni con funzione di stop,  
anticalcare  
**9,2 l/min Z class \***  
**Ø 115 mm**

blister / blister  
blister / blister 10AZA0140

Ø  
115  
Z class  
9,2 l/min  
5F



Ducha MOON / Hand shower MOON  
Douchette MOON / Doccetta MOON



Ducha NITE SQ / Hand shower NITE SQ  
Douchette NITE SQ / Doccetta NITE SQ



3 funciones / 3 functions  
3 fonctions / 3 funzioni



Ref: 10NIT0100

### MOON

Ducha de 3 funciones, anticalcárea  
3 functions hand shower, antiscaling  
Douchette 3 fonctions, anticalcaire  
Doccetta a 3 funzioni, anticalcare  
**7,8 l/min Z class \***  
**Ø 120 mm**

granel / bulk  
en vrac / sfuso 10MOO0100

blister / blister  
blister / blister 10MOO0140

caja / box  
boîte / scatola 10MOO0120

Ø  
120  
Z class  
7,8 l/min  
3F



3 funciones / 3 functions  
3 fonctions / 3 funzioni

### NITE SQ

Ducha de 3 funciones anticalcárea con  
botón para cambiar de función  
3 functions hand shower with button to  
change function, antiscaling  
Douchette 3 fonctions avec bouton pour  
changer les positions, anticalcaire  
Doccetta a 3 funzioni con pulsante per  
cambiare le posizioni, anticalcare  
**10,8 l/min Z class \***  
**110 x 80 mm**

granel / bulk  
en vrac / sfuso 10NIT0100

blister / blister  
blister / blister 10NIT0140

caja / box  
boîte / scatola 10NIT0120

100  
x  
80  
Z class  
10,8 l/min  
3F



### AZURE

Ducha LED azul 1 función, anticalcárea.  
Funciona sin pilas ni baterías  
Hand shower blue LED 1 function,  
antiscaling  
No batteries required  
Douchette avec LED bleu 1 fonction,  
anticalcaire  
Fonctionne sans piles ni batteries  
Doccetta con LED blu 1 funzione, anticalcare  
Funziona senza batterie  
**13,4 l/min A class \***  
**Ø 105 mm**

granel / bulk  
en vrac / sfuso 10AZU0100

caja / box  
boîte / scatola 10AZU0120

Ø  
105  
A class  
13,4 l/min  
1F



Ducha AZURE / Hand shower AZURE  
Douchette AZURE / Doccetta AZURE



Ref: 10MOO0100



### CROM

**Ducha de 2 funciones, anticalcárea**  
2 functions hand shower, antiscaling  
Douchette 2 fonctions, anticalcaire  
Doccetta a 2 funzioni, anticalcare  
**11,7 l/min Z class \***  
Ø 100 mm

granel / bulk  
en vrac / sfuso 10CRO0100

blister / blister  
blister / blister 10CRO0140

caja / box  
boîte / scatola 10CRO0120

Ø 100 Z class 11,7 l/min 2F

### ISABELA

**Ducha de 5 funciones, anticalcárea**  
5 functions hand shower, antiscaling  
Douchette 5 fonctions, anticalcaire  
Doccetta a 5 funzioni, anticalcare  
**10,1 l/min Z class \***  
Ø 115 mm

granel / bulk  
en vrac / sfuso 10ISA0100

bolsa / bag  
sachet / busta 10ISA0110

blister / blister  
blister / blister 10ISA0140

caja / box  
boîte / scatola 10ISA0120

Ø 115 Z class 10,1 l/min 5F

### BLU PLUS

**Ducha de 5 funciones con función stop, anticalcárea**  
Hand shower 5 functions with stop mode, antiscaling  
Douchette 5 fonctions avec fonction stop, anticalcaire  
Doccetta a 5 funzioni con funzione di stop, anticalcare  
**13,4 l/min A class \***  
Ø 112 mm

granel / bulk  
en vrac / sfuso 10BLP0100

bolsa / bag  
sachet / busta 10BLP0110

blister / blister  
blister / blister 10BLP0140

caja / box  
boîte / scatola 10BLP0120

Ø 112 A class 13,4 l/min 5F



### MED

**Ducha de 3 funciones, anticalcárea**  
3 functions hand shower, antiscaling  
Douchette 3 fonctions, anticalcaire  
Doccetta a 3 funzioni, anticalcare  
**12,0 l/min A class \***  
Ø 120 mm

granel / bulk  
en vrac / sfuso 10MED0100

bolsa / bag  
sachet / busta 10MED0110

blister / blister  
blister / blister 10MED0140

caja / box  
boîte / scatola 10MED0120

Ø 120 A class 12,0 l/min 3F

### ARTIC

**Ducha de 1 función, anticalcárea**  
1 function hand shower, antiscaling  
Douchette 1 fonction, anticalcaire  
Doccetta a 1 funzione, anticalcare  
**12,6 l/min A class \***  
60 x 80 mm

granel / bulk  
en vrac / sfuso 10ART0100

bolsa / bag  
sachet / busta 10ART0110

blister / blister  
blister / blister 10ART0140

caja / box  
boîte / scatola 10ART0120

60 x 80 A class 12,6 l/min 1F



### NICKOL

**Ducha de 3 funciones, anticalcárea**  
3 functions hand shower, antiscaling  
Douchette 3 fonctions, anticalcaire  
Doccetta a 3 funzioni, anticalcare  
**8,2 l/min Z class \***  
Ø 99 mm

granel / bulk  
en vrac / sfuso 10NIC0100

bolsa / bag  
sachet / busta 10NIC0110

blister / blister  
blister / blister 10NIC0140

caja / box  
boîte / scatola 10NIC0120

Ø 99 Z class 8,2 l/min 3F





Ducha MAUI / Hand shower MAUI  
Douchette MAUI / Doccetta MAUI



### MAUI

Ducha de 1 función, anticalcárea  
1 function hand shower, antiscaling  
Douchette 1 fonction, anticalcaire  
Doccetta a 1 funzione, anticalcare  
12,6 l/min A class \*  
60 x 80 mm

granel / bulk  
en vrac / sfuso 10MAU0100

bolsa / bag  
sachet / busta 10MAU0110

blister / blister  
blister / blister 10MAU0140

caja / box  
boîte / scatola 10MAU0120

60 x 80 A class  
12,6 l/min 1F

### WIND BLU SQ

Ducha de 1 función, anticalcárea  
1 function hand shower, antiscaling  
Douchette 1 fonction, anticalcaire  
Doccetta a 1 funzione, anticalcare  
14,5 l/min S class \*  
90 x 97 mm

granel / bulk  
en vrac / sfuso 10WIB0100

bolsa / bag  
sachet / busta 10WIB0110

blister / blister  
blister / blister 10WIB0140

caja / box  
boîte / scatola 10WIB0120

90 x 97 S class  
14,5 l/min 1F



Ducha WIND BLU SQ / Hand shower WIND BLU SQ  
Douchette WIND BLU SQ / Doccetta WIND BLU SQ

### 412

Ducha de 4 funciones, autolimpiable  
4 functions hand shower, self-cleaning  
Douchette 4 fonctions, autonettoyant  
Doccetta a 4 funzioni, autopulente  
16,7 l/min S class \*  
Ø 80 mm

granel / bulk  
en vrac / sfuso 104120100

bolsa / bag  
sachet / busta 104120110

blister / blister  
blister / blister 104120140

caja / box  
boîte / scatola 104120120

Ø 80 S class  
16,7 l/min 4F



### LUXOR

Ducha de 1 función, anticalcárea  
1 function hand shower, antiscaling  
Douchette 1 fonction, anticalcaire  
Doccetta a 1 funzione, anticalcare  
16,3 l/min S class \*  
42 x 73 mm

granel / bulk  
en vrac / sfuso 10LUX0100

bolsa / bag  
sachet / busta 10LUX0110

blister / blister  
blister / blister 10LUX0140

caja / box  
boîte / scatola 10LUX0120

42 x 73 S class  
16,3 l/min 1F



Ducha LUXOR / Hand shower LUXOR  
Douchette LUXOR / Doccetta LUXOR

\* Caudal a 3 bar: / \* Flow rate at 3 bar: / \* Débit à 3 bar: / \* Flusso a 3 bar:



### NIX

Ducha de 1 función, anticalcárea  
1 function hand shower, antiscaling  
Douchette 1 fonction, anticalcaire  
Doccetta a 1 funzione, anticalcare  
13,3 l/min A class \*  
Ø 106 mm

granel / bulk  
en vrac / sfuso 10NIX0100

blister / blister  
blister / blister 10NIX0140

caja / box  
boîte / scatola 10NIX0120

Ø 106 A class  
13,3 l/min 1F

### 411

Ducha de 4 funciones, autolimpiable  
4 functions hand shower, self-cleaning  
Douchette 4 fonctions, autonettoyant  
Doccetta a 4 funzioni, autopulente  
12,8 l/min A class \*  
Ø 85 mm

granel / bulk  
en vrac / sfuso 104110100

bolsa / bag  
sachet / busta 104110110

blister / blister  
blister / blister 104110140

caja / box  
boîte / scatola 104110120

Ø 85 A class  
12,8 l/min 4F



Ducha NIX / Hand shower NIX  
Douchette NIX / Doccetta NIX

\* Caudal a 3 bar: / \* Flow rate at 3 bar: / \* Débit à 3 bar: / \* Flusso a 3 bar:



### 801

**Ducha de 8 funciones**  
8 functions hand shower  
Douchette 8 fonctions  
Doccetta a 8 funzioni  
**13,0 l/min A class \***  
Ø 80 mm

**granel / bulk**  
en vrac / sfuso 108010100

**bolsa / bag**  
sachet / busta 108010110

**blister / blister**  
blister / blister 108010140

**caja / box**  
boîte / scatola 108010120

Ø 80 **A class**  
13,0 l/min **8F**



### MINIMALISTA

**Ducha de 1 función, anticalcárea**  
1 function hand shower, antiscaling  
Douchette 1 fonction, anticalcaire  
Doccetta a 1 funzione, anticalcare  
**16,7 l/min S class \***  
Ø 30 mm

**granel / bulk**  
en vrac / sfuso 10MIN0100

**bolsa / bag**  
sachet / busta 10MIN0110

Ø 30 **S class**  
16,7 l/min **1F**



### BLUET

**Ducha de 5 funciones, anticalcárea**  
5 functions hand shower, antiscaling  
Douchette 5 fonctions, anticalcaire  
Doccetta a 5 funzioni, anticalcare  
**7,5 l/min Z class \***  
Ø 90 mm

**granel / bulk**  
en vrac / sfuso 10BLE0100

**bolsa / bag**  
sachet / busta 10BLE0110

**blister / blister**  
blister / blister 10BLE0140

**caja / box**  
boîte / scatola 10BLE0120

Ø 90 **Z class**  
7,5 l/min **5F**



Ducha MINIMALISTA / Hand shower MINIMALISTA  
Douchette MINIMALISTA / Doccetta MINIMALISTA

\* Caudal a 3 bar: / \* Flow rate at 3 bar: / \* Débit à 3 bar: / \* Flusso a 3 bar:



### 112

**Ducha de 1 función, anticalcárea**  
1 function hand shower, antiscaling  
Douchette 1 fonction, anticalcaire  
Doccetta a 1 funzione, anticalcare  
**14,2 l/min A class \***  
Ø 90 mm

**granel / bulk**  
en vrac / sfuso 101120100

**bolsa / bag**  
sachet / busta 101120110

**blister / blister**  
blister / blister 101120140

**caja / box**  
boîte / scatola 101120120

Ø 90 **A class**  
14,2 l/min **1F**



### ZION

**Ducha de 1 función, anticalcárea**  
1 function hand shower, antiscaling  
Douchette 1 fonction, anticalcaire  
Doccetta a 1 funzione, anticalcare  
**12,5 l/min A class \***  
Ø 83 mm

**granel / bulk**  
en vrac / sfuso 10ZIO0100

**bolsa / bag**  
sachet / busta 10ZIO0110

**blister / blister**  
blister / blister 10ZIO0140

**caja / box**  
boîte / scatola 10ZIO0120

Ø 83 **A class**  
12,5 l/min **1F**



### 111

**Ducha de 1 función, anticalcárea**  
1 function hand shower, antiscaling  
Douchette 1 fonction, anticalcaire  
Doccetta a 1 funzione, anticalcare  
**11,0 l/min Z class \***  
Ø 67 mm

**granel / bulk**  
en vrac / sfuso 101110100

**bolsa / bag**  
sachet / busta 101110110

**blister / blister**  
blister / blister 101110140

**caja / box**  
boîte / scatola 101110120

Ø 67 **Z class**  
11,0 l/min **1F**



### BARI

**Ducha de 3 funciones, anticalcárea**  
3 functions hand shower, antiscaling  
Douchette 3 fonctions, anticalcaire  
Doccetta a 3 funzioni, anticalcare  
**10,0 l/min Z class \***  
Ø 80 mm

**granel / bulk**  
en vrac / sfuso 10BAR0100

**bolsa / bag**  
sachet / busta 10BAR0110

**blister / blister**  
blister / blister 10BAR0140

**caja / box**  
boîte / scatola 10BAR0120

Ø 80 **Z class**  
10,0 l/min **3F**



### 111G

**Ducha de 1 función, anticalcárea**  
1 function hand shower, antiscaling  
Douchette 1 fonction, anticalcaire  
Doccetta a 1 funzione, anticalcare  
**11,3 l/min Z class \***  
Ø 67 mm

**granel / bulk**  
en vrac / sfuso 1011G0100

**bolsa / bag**  
sachet / busta 1011G0110

**caja / box**  
boîte / scatola 1011G0120

Ø 67 **Z class**  
11,3 l/min **1F**



### 111BL

**Ducha de 1 función, anticalcárea, blanca**  
1 function hand shower, antiscaling, white  
Douchette 1 fonction, anticalcaire, blanc  
Doccetta a 1 funzione, anticalcare, bianca  
**11,0 l/min Z class \***  
Ø 67 mm

**granel / bulk**  
en vrac / sfuso 101110300

**bolsa / bag**  
sachet / busta 101110310

**caja / box**  
boîte / scatola 101110320

Ø 67 **Z class**  
11,0 l/min **1F**



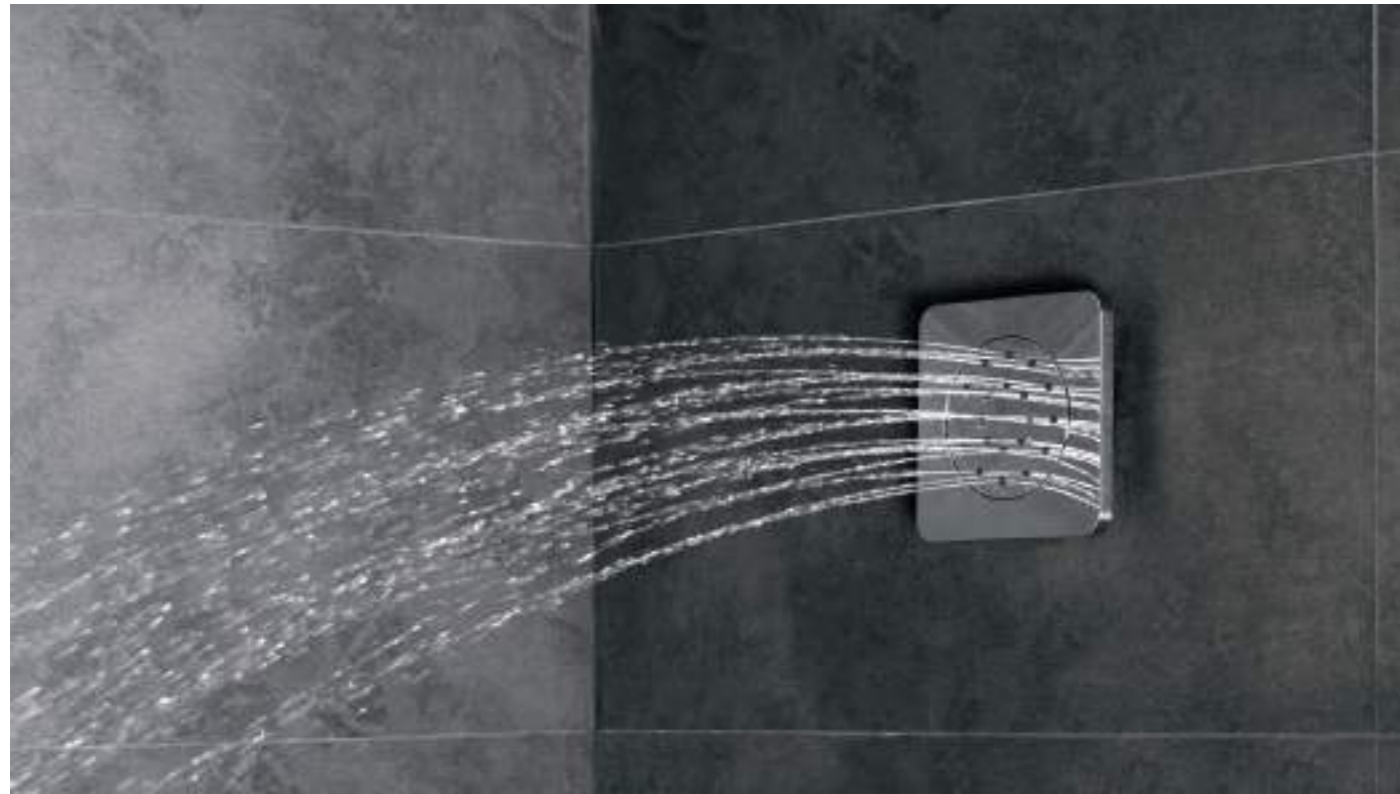

**JET R**

**Jet de empotrar antical, orientable, con caja de instalación.**  
**Con limitador de caudal 9,2 l/m. 1 función**  
 Concealed Jet antiscaling, swiveling, with installation box.  
 With flow reductor 9,2 l/m. 1 function  
 Jet encastré anticalcaire, orientable, avec boîte d'installation.  
 Avec réducteur de débit 9,2l/m. 1 fonction  
 Getto incassato, anticalcare, regolabile, con scatola di installazione.  
 Con riduttore di flusso 9,2 l / m. 1 funzione

caja / box  
 boîte / scatola **19JER0125**

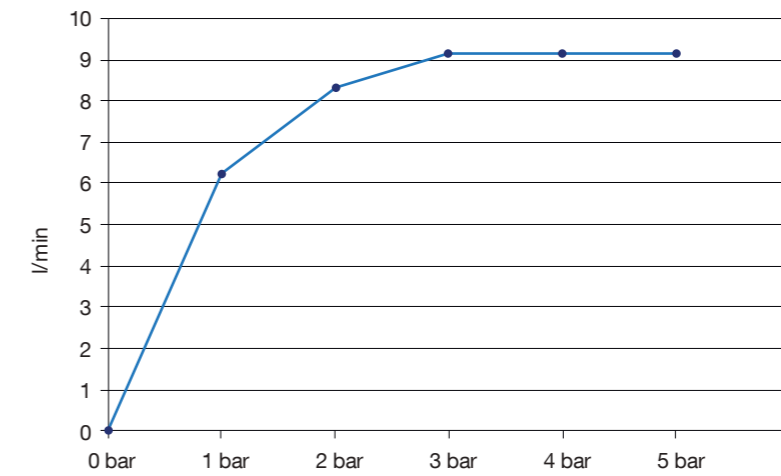
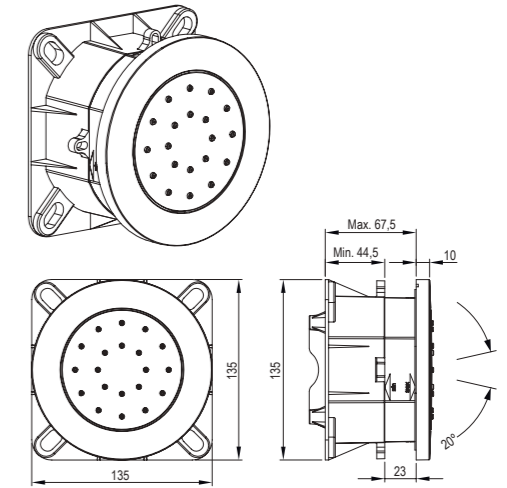

**JET C**

**Jet de empotrar antical, orientable, con caja de instalación.**  
**Con limitador de caudal 9,2 l/m. 1 función**  
 Concealed Jet antiscaling, swiveling, with installation box.  
 With flow reductor 9,2 l/m. 1 function  
 Jet encastré anticalcaire, orientable, avec boîte d'installation.  
 Avec réducteur de débit 9,2l/m. 1 fonction  
 Getto incassato, anticalcare, regolabile, con scatola di installazione.  
 Con riduttore di flusso 9,2 l / m. 1 funzione

caja / box  
 boîte / scatola **19JEC0125**

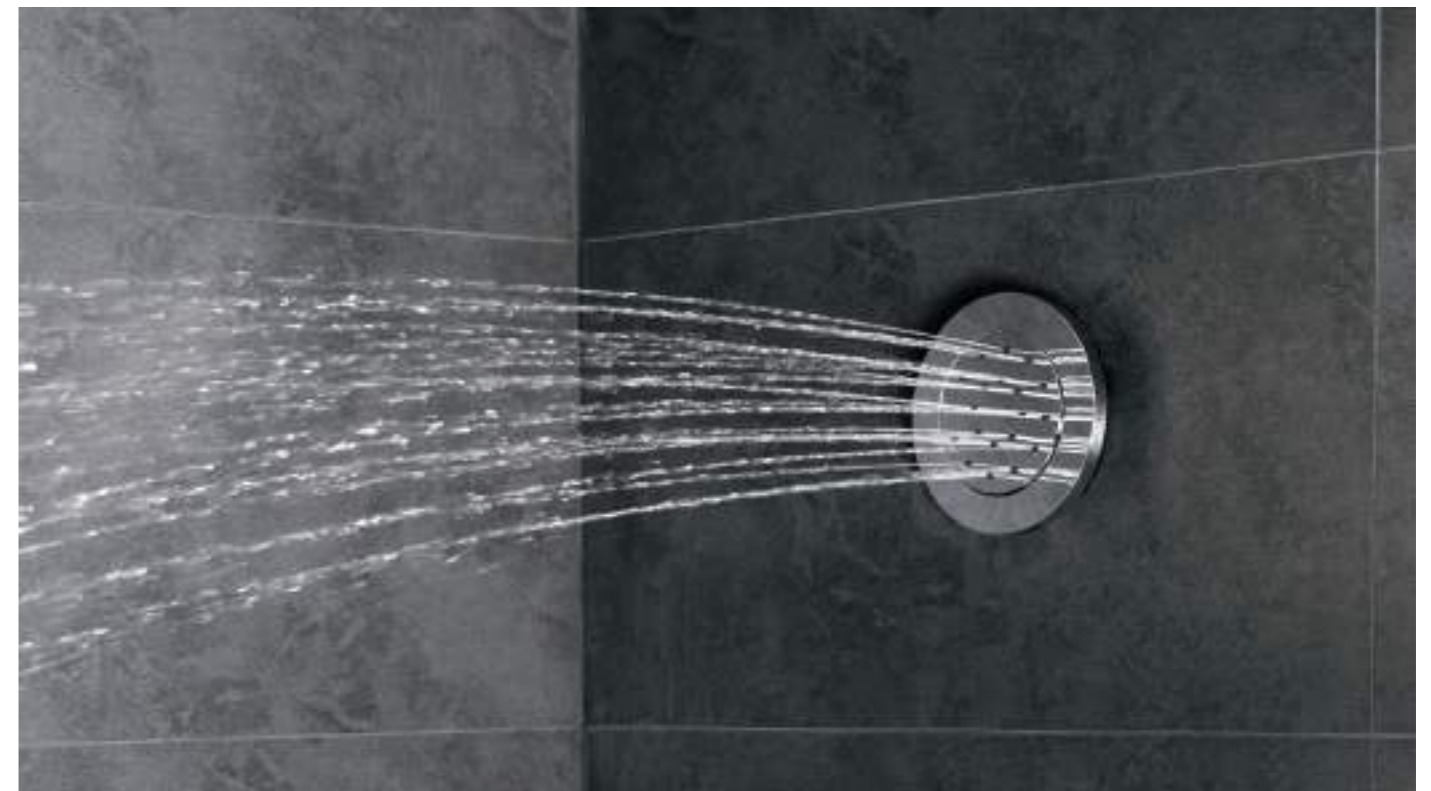
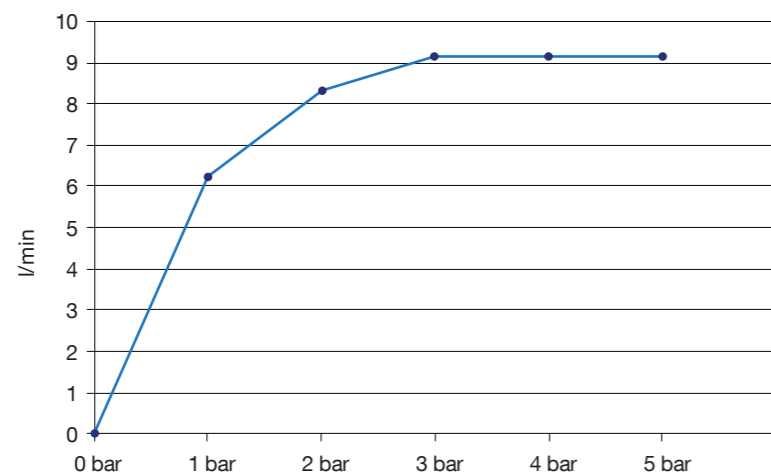
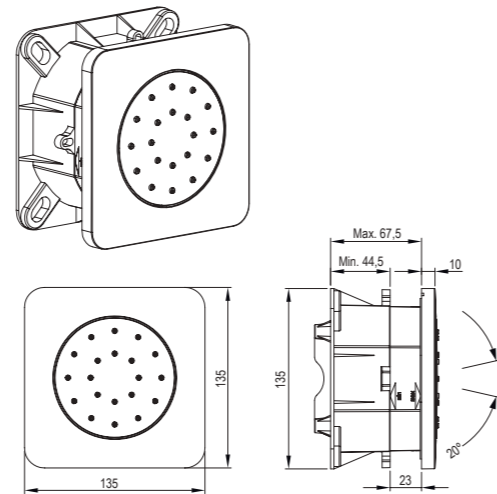

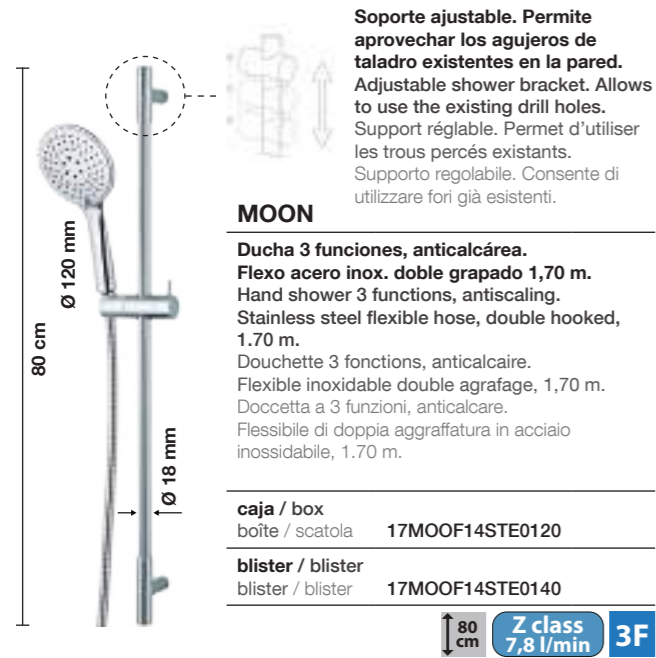

Conjunto de ducha MOON / Shower bar kit MOON  
Ensemble de douche MOON / Insemi doccia MOON



3 funciones / 3 functions  
3 fonctions / 3 funzioni



Ref: 17MOOF14STE0120

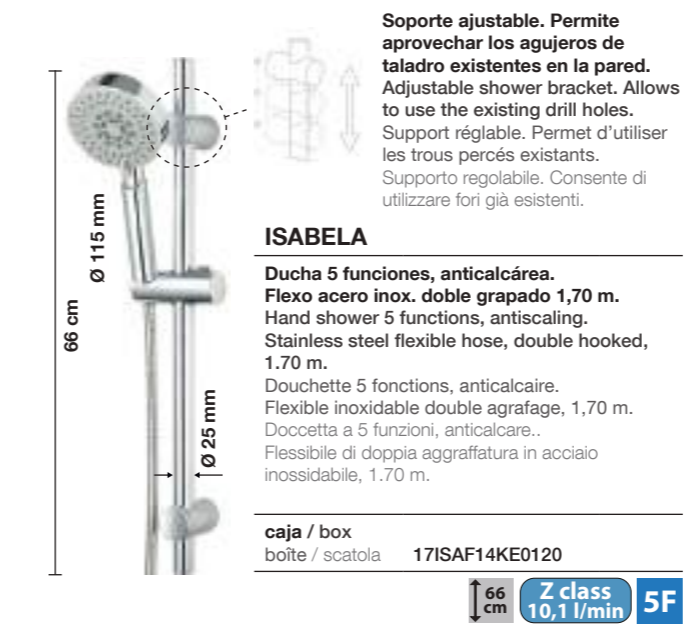
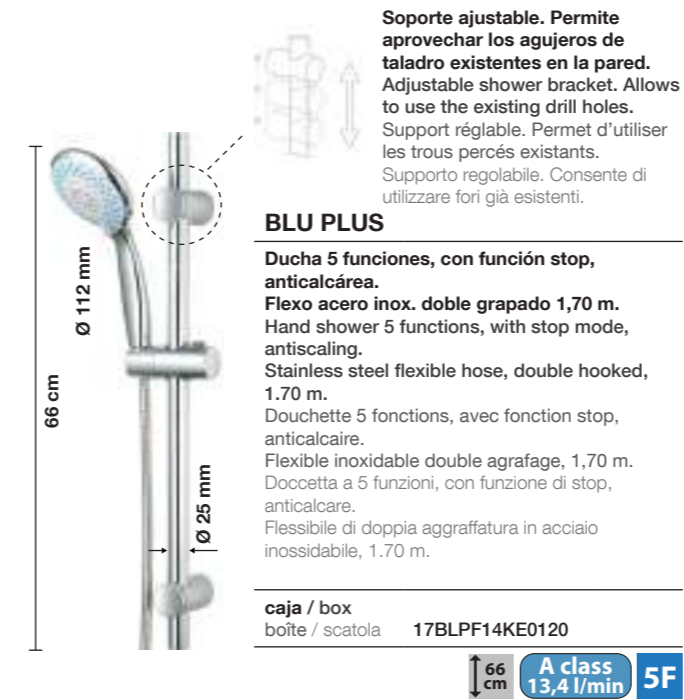
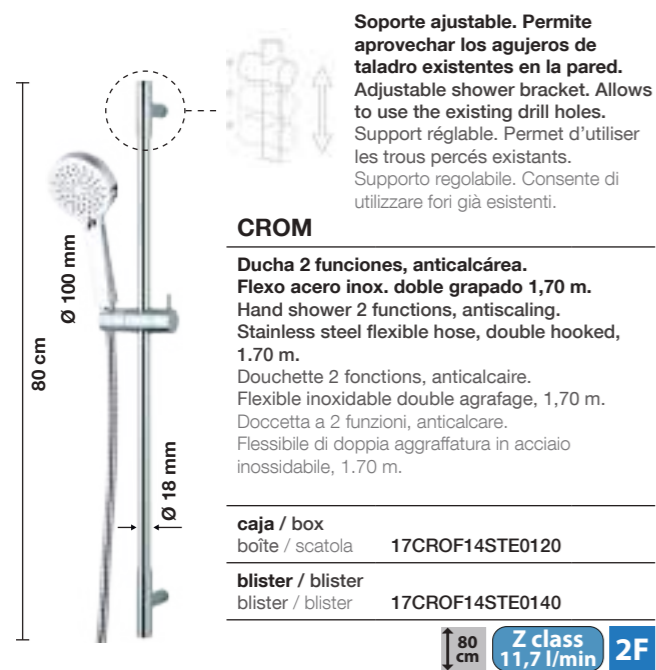

Conjunto de ducha BLU PLUS / Shower bar kit BLU PLUS  
Ensemble de douche BLU PLUS / Insemi doccia BLU PLUS

**Soporte ajustable. Permite aprovechar los agujeros de taladro existentes en la pared. Adjustable shower bracket. Allows to use the existing drill holes. Support réglable. Permet d'utiliser les trous percés existants. Supporto regolabile. Consente di utilizzare fori già esistenti.**

**MED**

**Ducha 3 funciones, anticalcárea. Flexo acero inox. doble grapado 1,70 m. Hand shower 3 functions, antiscaling. Stainless steel flexible hose, double hooked, 1.70 m. Douchette 3 fonctions, anticalcaire. Flexible inoxydable double agrafage, 1,70 m. Doccetta a 3 funzioni, anticalcare. Flessibile di doppia aggraffatura in acciaio inossidabile, 1.70 m.**

caja / box  
boîte / scatola 17MEDF14QU0120

66 cm A class 12,0 l/min 3F

**Soportes ajustables. Permiten aprovechar los agujeros de taladro existentes en la pared. Adjustable shower brackets. Allows to use the existing drill holes. Supports réglables. Permet d'utiliser les trous percés existants. Supporto regolabile. Consente di utilizzare fori già esistenti.**

**COM**

**Ducha 5 funciones, anticalcárea. Flexo acero inox. doble grapado 1,70 m. Hand shower of 5 functions antiscaling. Stainless steel flexible hose, double hooked 1.70 m. Douchette 5 fonctions, anticalcaire. Flexible inoxydable double agrafage, 1,70 m. Doccetta a 5 funzioni, anticalcare. Flessibile di doppia aggraffatura in acciaio inossidabile, 1.70 m.**

caja / box  
boîte / scatola 17ISAF14COM0120

66 cm Z class 10,1 l/min 5F

**MIN**

**Ducha 1 función anticalcárea. Flexo acero inox. doble grapado 1,70 m. Hand shower 1 function, antiscaling. Stainless steel flexible hose, double hooked 1.70 m. Douchette 1 fonction, anticalcaire. Flexible inoxydable double agrafage, 1,70 m. Doccetta a 1 funzione, anticalcare. Flessibile di doppia aggraffatura in acciaio inossidabile, 1.70 m.**

caja / box  
boîte / scatola 17MINF14MIN0120

60 cm S class 16,7 l/min 1F

**BARI**

**Ducha 3 funciones, anticalcárea. Flexo acero inox. doble grapado 1,70 m. Hand shower 3 functions, antiscaling. Stainless steel flexible hose, double hooked, 1.70 m. Douchette 3 fonctions, anticalcaire. Flexible inoxydable double agrafage, 1,70 m. Doccetta a 3 funzioni, anticalcare. Flessibile di doppia aggraffatura in acciaio inossidabile, 1.70 m.**

caja / box  
boîte / scatola 17BARF14MIN0120

60 cm Z class 10,0 l/min 3F

**MAUI**

**Ducha 1 función, anticalcárea. Flexo acero inox. doble grapado 1,70 m. Hand shower 1 function, antiscaling. Stainless steel flexible hose, double hooked 1.70 m. Douchette 1 fonction, anticalcaire. Flexible inoxydable double agrafage, 1,70 m. Doccetta a 1 funzione, anticalcare. Flessibile di doppia aggraffatura in acciaio inossidabile, 1.70 m.**

caja / box  
boîte / scatola 17MAUF14QUA0120

65,5 cm A class 12,6 l/min 1F

**MED**

**Ducha 3 funciones, anticalcárea. Soporte regulable cromado. Flexo acero inox. doble grapado 1,5 m. Hand shower 3 functions, antiscaling. Rotative shower bracket, chrome. Stainless steel flexible hose, double hooked, 1.5 m. Douchette 3 fonctions, anticalcaire. Support inclinable, chromé. Flexible inoxydable double agrafage, 1,5 m. Doccetta a 3 funzioni, anticalcare. Supporto inclinabile, cromato. Flessibile di doppia aggraffatura in acciaio inossidabile, 1.5 m.**

blister / blister  
blister / blister 16MEDF13MIN0130

120 A class 12,0 l/min 3F

**112**

**Ducha 1 función, anticalcárea. Soporte regulable cromado. Flexo acero inox. doble grapado 1,7 m. Hand shower, 1 function, antiscaling. Rotative shower bracket, chrome. Stainless steel flexible hose, double hooked, 1.7 m. Douchette 1 fonction, anticalcaire. Support inclinable, chromé. Flexible inoxydable double agrafage, 1,7 m. Doccetta a 1 funzione, anticalcare. Supporto inclinabile, cromato. Flessibile di doppia aggraffatura in acciaio inossidabile, 1.7 m.**

blister / blister  
blister / blister 16112F14SCN0140

90 A class 14,2 l/min 1F

**CROM**

**Ducha 2 función, anticalcárea. Soporte regulable cromado. Flexo acero inox. doble grapado 1,7 m. Hand shower, 2 functions, antiscaling. Rotative shower bracket, chrome. Stainless steel flexible hose, double hooked, 1.7 m. Douchette 2 fonctions, anticalcaire. Support inclinable, chromé. Flexible inoxydable double agrafage, 1,7 m. Doccetta a 2 funzioni, anticalcare. Supporto inclinabile, cromato. Flessibile di doppia aggraffatura in acciaio inossidabile, 1.7 m.**

blister / blister  
blister / blister 16CROF14SMI0140

100 Z class 11,7 l/min 2F

**BLU PLUS**

**Ducha 5 funciones anticalcárea. Soporte regulable cromado. Flexo acero inox. doble grapado 1,5 m. Hand shower 5 functions, antiscaling. Rotative shower bracket, chrome. Stainless steel flexible hose, double hooked 1.5 m. Douchette 5 fonctions, anticalcaire. Support inclinable, chromé. Flexible inoxydable double agrafage, 1,7 m. Doccetta a 5 funzioni, anticalcare. Supporto inclinabile, cromato. Flessibile di doppia aggraffatura in acciaio inossidabile, 1.5 m.**

blister / blister  
blister / blister 16BLPF13SCN0130

112 A class 12,0 l/min 5F

**LAKE**

**Ducha 8 funciones. Soporte regulable cromado. Flexo acero inox. doble grapado 1,5 m. Hand shower 8 functions. Rotative shower bracket, chrome. Stainless steel flexible hose, double hooked, 1,5 m. Douchette 8 fonctions. Support inclinable, chromé. Flexible inoxydable double agrafage, 1,5 m. Doccetta a 8 funzioni. Supporto inclinabile, cromato. Flessibile di doppia aggraffatura in acciaio inossidabile, 1,5 m.**

blister / blister  
blister / blister 16LAKF13SCN0130

80 A class 13,0 l/min 8F

**NIX**

**Ducha 1 función, anticalcárea. Soporte regulable cromado. Flexo acero inox. doble grapado 1,7 m. Hand shower, 1 function, antiscaling. Rotative shower bracket, chrome. Stainless steel flexible hose, double hooked, 1.7 m. Douchette 1 fonction, anticalcaire. Support inclinable, chromé. Flexible inoxydable double agrafage, 1,7 m. Doccetta a 1 funzione, anticalcare. Supporto inclinabile, cromato. Flessibile di doppia aggraffatura in acciaio inossidabile, 1.7 m.**

cartón / carton  
carton / cartone 16NIXF14S110150

106 ZZ class 6,7 l/min 1F

**Soposte ajustable. Permite aprovechar los agujeros de taladro existentes en la pared.**  
Adjustable shower bracket. Allows to use the existing drill holes.  
Support réglable. Permet d'utiliser les trous percés existants.  
Supporto regolabile. Consente di utilizzare fori già esistenti.

**STEAM**

**Barra deslizante diámetro 18 mm, de longitud 80 cm**  
Sliding bar, diameter 18 mm, length 80 cm.  
Barre glissante diamètre 18 mm, longueur 80 cm.  
Barra scorrevole diametro 18 mm, lunghezza 80 cm.

granel / bulk en vrac / sfuso	15STE0100
caja / box boîte / scatola	15STE0120

Ø 18 80 cm

**MIN**

**Barra deslizante, diámetro 18 mm, de longitud 60 cm**  
Sliding bar, diameter 18 mm, length 60 cm.  
Barre glissante diamètre 18 mm, longueur 60 cm.  
Barra scorrevole diametro 18 mm, lunghezza 60 cm.

granel / bulk en vrac / sfuso	15MIN0100
bolsa / bag sachet / busta	15MIN0110
caja / box boîte / scatola	15MIN0120

Ø 18 60 cm

**Soposte ajustable. Permite aprovechar los agujeros de taladro existentes en la pared.**  
Adjustable shower bracket. Allows to use the existing drill holes.  
Support réglable. Permet d'utiliser les trous percés existants.  
Supporto regolabile. Consente di utilizzare fori già esistenti.

**QU**

**Barra deslizante, diámetro 25 mm, de longitud 66 cm**  
Sliding bar, diameter 25 mm, length 66 cm.  
Barre glissante diamètre 25 mm, longueur 66 cm.  
Barra scorrevole diametro 25 mm, lunghezza 66 cm.

granel / bulk en vrac / sfuso	15QU0100
bolsa / bag sachet / busta	15QU0110
caja / box boîte / scatola	15QU0120

Ø 25 66 cm



Barra de ducha STEAM / Sliding bar STEAM  
Barre glissante STEAM / Barra scorrevole STEAM

**Soposte ajustable. Permite aprovechar los agujeros de taladro existentes en la pared.**  
Adjustable shower bracket. Allows to use the existing drill holes.  
Support réglable. Permet d'utiliser les trous percés existants.  
Supporto regolabile. Consente di utilizzare fori già esistenti.

**KE**

**Barra deslizante, diámetro 25 mm, de longitud 66 cm**  
Sliding bar, diameter 25 mm, length 66 cm.  
Barre glissante diamètre 25 mm, longueur 66 cm.  
Barra scorrevole diametro 25 mm, lunghezza 66 cm.

granel / bulk en vrac / sfuso	15KE0100
bolsa / bag sachet / busta	15KE0110
caja / box boîte / scatola	15KE0120

Ø 25 66 cm

**Soportes ajustables. Permiten aprovechar los agujeros de taladro existentes en la pared.**  
Adjustable shower brackets. Allows to use the existing drill holes.  
Supports réglables. Permet d'utiliser les trous percés existants.  
Supporto regolabile. Consente di utilizzare fori già esistenti.

**COM**

**Barra deslizante, diámetro 25 mm, de longitud 66 cm**  
Sliding bar, diameter 25 mm, length 66 cm.  
Barre glissante diamètre 25 mm, longueur 66 cm.  
Barra scorrevole diametro 25 mm, lunghezza 66 cm.

granel / bulk en vrac / sfuso	15COM0100
bolsa / bag sachet / busta	15COM0110
caja / box boîte / scatola	15COM0120

Ø 25 66 cm

**QUATRO**

**Barra deslizante de 15x30 mm, de longitud 65,5 cm**  
Sliding bar 15x30 mm, length 65,5 cm.  
Barre glissante diamètre 15x30 mm, longueur 65,5 cm.  
Barra scorrevole 15 x 30 mm, lunghezza 65,5 cm.

**Sin jabonera / Without soap dish**  
Sans porte-savon / Senza portasapone

granel / bulk en vrac / sfuso	15QUA0100
bolsa / bag sachet / busta	15QUA0110
caja / box boîte / scatola	15QUA0120

**Con jabonera / With soap dish**  
Avec porte-savon / Con portasapone

granel / bulk en vrac / sfuso	15QUJ0100
bolsa / bag sachet / busta	15QUJ0110
caja / box boîte / scatola	15QUJ0120

15 x 30 mm 65,5 cm



Barra de ducha KE / Sliding bar KE  
Barre glissante KE / Barra scorrevole KE

**L28**

**Barra deslizante, diámetro 28 mm, de longitud 65 cm, cromo satinado**  
Sliding bar, diameter 28 mm, length 65 cm, satin-chrome.  
Barre glissante diamètre 28 mm, longueur 65 cm, chrome satinée.  
Barra scorrevole diametro 28 mm, lunghezza 65 cm, cromo satinato.

granel / bulk en vrac / sfuso	15L280100
bolsa / bag sachet / busta	15L280110
caja / box boîte / scatola	15L280120

Ø 28 65 cm

### QUADRA

**Soporte orientable, cromo**  
Rotative shower bracket, chrome  
Support inclinable, chromé  
Supporto inclinabile, cromato

**granel / bulk**  
en vrac / sfuso **13SQU0100**

**bolsa / bag**  
sachet / busta **13SQU0110**

**blister / blister**  
blister / blister **13SQU0140**



### MINIMALISTA

**Soporte orientable, cromo**  
Rotative shower bracket, chrome  
Support inclinable, chromé  
Supporto inclinabile, cromato

**granel / bulk**  
en vrac / sfuso **13SMI0100**

**bolsa / bag**  
sachet / busta **13SMI0110**

**blister / blister**  
blister / blister **13SMI0140**



### FIX'D

**Soporte fijo, cromo**  
Fixed shower bracket, chrome  
Support fixe, chromé  
Supporto fisso, cromato

**granel / bulk**  
en vrac / sfuso **13SFI0100**

**bolsa / bag**  
sachet / busta **13SFI0110**



### SCB

**Soporte orientable, cromo**  
Rotative shower bracket, chrome  
Support inclinable, blanc  
Supporto inclinabile, bianco

**granel / bulk**  
en vrac / sfuso **13SCB0300**



### SCN

**Soporte orientable, cromo**  
Rotative shower bracket, chrome  
Support inclinable, chromé  
Supporto inclinabile, cromato

**granel / bulk**  
en vrac / sfuso **13SCN0100**

**bolsa / bag**  
sachet / busta **13SCN0110**

**blister / blister**  
blister / blister **13SCN0140**



Toma de agua RCT / Water outlet RCT  
Prise de l'eau RCT / Presa d'acqua RCT



### RCT

**Soporte fijo con toma a pared redondo**  
Fixed bracket with round wall outlet  
Support fixe avec prise au mur rond  
Supporto fisso con presa a muro rotonda

**19RCT0125**

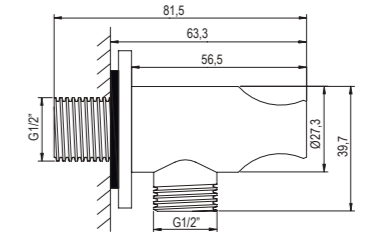

### CCT

**Soporte fijo con toma a pared cuadrado**  
Fixed bracket with square wall outlet  
Support fixe avec prise au mur carré  
Supporto fisso con presa a muro quadrata

**19CCT0125**

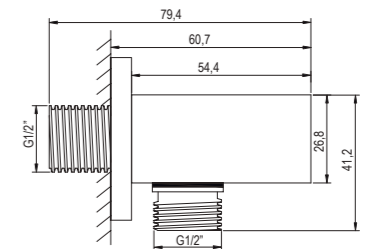

### RST

**Toma a pared redonda**  
Round shower elbow connection  
Prise au mur ronde  
Presa a muro rotonda

**19RST0125**

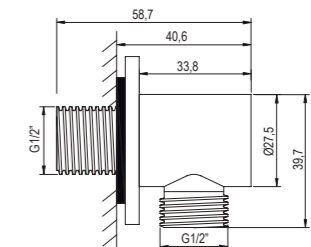

### CST

**Toma a pared cuadrada**  
Square shower elbow connection  
Prise au mur carré  
Presa a muro quadrata

**19CST0125**

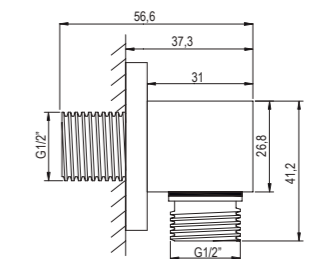



### F1

**Flexo de acero inoxidable AISI304 de 1,80, extensible 1,80-2,45m, doble grapado, tuercas latón, tubo interior de EPDM**  
Stainless steel flexible hose AISI 304 extensible min. 1.80 max. 2.45 m, double hooked, brass nuts, inner tube EPDM

Flexible en acier inoxydable AISI 304, extensible min. 1.80 max. 2.45 m, double agrafage, raccords en laiton, tube interne en EPDM  
Flessibile in acciaio inossidabile AISI 304, estensibile min. 1.80 max. 2.45 m, doppia aggraffatura, dadi in ottone, camera d'aria in EPDM

**granel / bulk**  
en vrac / sfuso 14F11800100

**bolsa / bag**  
sachet / busta 14F11800110

**cartón / carton**  
carton / cartone 14F11800150



### AQUASILVER

**Flexo de PVC plateado, tuercas latón**  
PVC flexible hose silver, brass nuts  
Flexible en PVC argenté, raccords en laiton  
Flessibile in PVC argento, dadi in ottone

**1,75 m**

**granel / bulk**  
en vrac / sfuso 14AQU1750600

**bolsa / bag**  
sachet / busta 14AQU1750610

**blister / blister**  
blister / blister 14AQU1750640

**0,70 m**

**granel / bulk**  
en vrac / sfuso 14AQU0700600

**bolsa / bag**  
sachet / busta 14AQU0700610



### F11

**Flexo de acero inoxidable de 1,80, extensible 1,80-2,45 m, doble grapado, tuercas latón, tubo interior de EPDM**  
Stainless steel flexible hose extensible min. 1.80 max. 2.45 m, double hooked, brass nuts, inner tube EPDM

Flexible en acier inoxydable, extensible min. 1.80 max. 2.45 m, double agrafage, raccords en laiton, tube interne en EPDM  
Flessibile in acciaio inossidabile, estensibile min. 1.80 max. 2.45 m, doppia aggraffatura, dadi in ottone, camera d'aria in EPDM

**granel / bulk**  
en vrac / sfuso 14F111800100

**bolsa / bag**  
sachet / busta 14F111800110



### F7

**Flexo Acero Inoxidable de 0,7 m, doble grapado, tuercas ABS, tubo interior de PVC**  
Stainless steel flexible hose 0.7 m, double hooked, ABS nuts, PVC inner tube  
Flexible en acier inoxydable 0,7 m, double agrafage, raccords en ABS, tube interne en PVC  
Flessibile in acciaio inossidabile 0.7 m., doppia aggraffatura, dadi in ABS, camera d'aria in PVC

**granel / bulk**  
en vrac / sfuso 14F70700100

**bolsa / bag**  
sachet / busta 14F70700110

### AQUABLACK

**Flexo de PVC negro mate 1,75 m, tuercas latón**  
PVC flexible hose, black matt, 1.75 m, brass nuts  
Flexible in PVC noir mat 1,75 m, raccords en laiton  
Flessibile in PVC nero opaco, 1.75 m, dadi in ottone

**granel / bulk**  
en vrac / sfuso 14AQU1750500

**bolsa / bag**  
sachet / busta 14AQU1750510



### F13

**Flexo acero inoxidable de 1,5 m, doble grapado, tuercas metálicas, tubo interior de PVC**  
Stainless steel flexible hose 1.5m, double hooked, metallic nuts, PVC inner tube  
Flexible en acier inoxydable 1,5 m, double agrafage, raccords métalliques, tube interne en PVC  
Flessibile in acciaio inossidabile 1.5m, doppia aggraffatura, dadi di metallo, camera d'aria in PVC

**granel / bulk**  
en vrac / sfuso 14F131500100

**bolsa / bag**  
sachet / busta 14F131500110



### F14

**Flexo acero inoxidable de 1,7 m, doble grapado, tuercas metálicas, tubo interior de PVC**  
Stainless steel flexible hose 1.7m, double hooked, metallic nuts, PVC inner tube  
Flexible en acier inoxydable 1,7 m, double agrafage, raccords métalliques, tube interne en PVC  
Flessibile in acciaio inossidabile 1.7 m, doppia aggraffatura, dadi di metallo, camera d'aria in PVC

**granel / bulk**  
en vrac / sfuso 14F141700100

**bolsa / bag**  
sachet / busta 14F141700110



### F15

**Flexo acero inoxidable de 2,0 m, doble grapado, tuercas metálicas, tubo interior de PVC**  
Stainless steel flexible hose, double hooked, conical, 2.0 m, metallic nuts, PVC inner tube  
Flexible en acier inoxydable 2,0 m, double agrafage, raccords métalliques, tube interne en PVC  
Flessibile di doppia aggraffatura in acciaio inossidabile 2.0 m, dadi di metallo, camera d'aria in PVC

**granel / bulk**  
en vrac / sfuso 14F152000100

**bolsa / bag**  
sachet / busta 14F152000110



### BIFLEX BLANCO

**Flexo de PVC cromo/blanco 1,50 m, tuercas ABS**  
PVC flexible hose, chrome/white 1.50 m, ABS nuts  
Flexible in PVC chrome/blanc 1,5 m, raccords en ABS  
Flessibile in PVC cromo/bianco 1.50 m, dadi in ABS

**granel / bulk**  
en vrac / sfuso 14BIF1500300

**bolsa / bag**  
sachet / busta 14BIF1500310



### AQUAWHITE

**Flexo de PVC blanco 1,75 m, tuercas latón**  
PVC flexible hose, white, 1.75 m, brass nuts  
Flexible in PVC blanc 1,75 m, raccords en laiton  
Flessibile in PVC bianco, 1.75 m, dadi in ottone

**granel / bulk**  
en vrac / sfuso 14AQU1750300

**bolsa / bag**  
sachet / busta 14AQU1750310



### F19

**Flexo acero inoxidable de 1,5 m, doble grapado, tuercas ABS, tubo interior de EPDM**  
Stainless steel flexible hose 1.5 m, double hooked, ABS nuts, EPDM inner tube  
Flexible en acier inoxydable 1,5 m, double agrafage, raccords en ABS, tube interne en EPDM  
Flessibile in acciaio inossidabile 1.5 m, doppia aggraffatura, dadi in ABS, camera d'aria in EPDM

**granel / bulk**  
en vrac / sfuso 14F191500100

**bolsa / bag**  
sachet / busta 14F191500110



### F20

**Flexo Acero Inoxidable de 1,7 m, doble grapado, tuercas ABS, tubo interior de EPDM**  
Stainless steel flexible hose 1.7 m, double hooked, ABS nuts, EPDM inner tube  
Flexible en acier inoxydable 1,7 m, double agrafage, raccords en ABS, tube interne en EPDM  
Flessibile in acciaio inossidabile 1.7 m, doppia aggraffatura, dadi in ABS, camera d'aria in EPDM

**granel / bulk**  
en vrac / sfuso 14F201700100

**bolsa / bag**  
sachet / busta 14F201700110



### F21

**Flexo acero inoxidable de 2,0 m, doble grapado, tuercas ABS, tubo interior de EPDM**  
Stainless steel flexible hose 2.0 m, double hooked, ABS nuts, EPDM inner tube  
Flexible en acier inoxydable 2,0 m, double agrafage, raccords en ABS, tube interne en EPDM  
Flessibile di doppia aggraffatura in acciaio inossidabile 2.0 m, dadi in ABS, camera d'aria in EPDM

**bolsa / bag**  
sachet / busta 14F212000110





**BIDÉ WC**  
**BIDET WC**  
**BIDET WC**  
**BIDE WC**

BIDÉ WC  
BIDET WC

**ARES**

**Kit mezclador para bidet. Monomando fabricado en latón estampado que garantiza la ausencia de porosidades y filtraciones de agua. Flexo con estructura interna extra reforzada. Apto para instalar a ambos lados del WC. Ducha pulsante de cierre de latón.**

**Bidet Mixer Kit. Single lever bidet mixer manufactured in stamping brass that guarantees the total absence of porosities and water filtrations. Flexible hose extra reinforced with internal structure. Suitable to install on both sides of WC. Hand shower with open/close pushbutton in brass.**

**Kit mélangeur pour bidet. Mitigeur fabriqué en laiton imprimé qui garantit l'absence de porosité et de fuite d'eau. Flexible avec structure interne extra renforcée. Habilité pour une installation des deux côtés des WC. Douchette à poussoir en laiton.**

**Kit miscelatore per bidet. Miscelatore monocomando realizzato in ottone stampato che garantisce l'assenza di porosità e perdite d'acqua. Flexibile con struttura interna extra rinforzata. Adatto per l'installazione su entrambi i lati del WC. Doccetta di chiusura pulsante in ottone.**

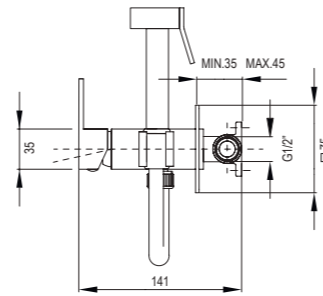

TESTED

**Cromo / Chrome / Chromé / Cromato**

**34ARE0010120 7 l/min 3 bar**

**Negro / Black / Noir / Nero**

**34ARE0010520 7 l/min 3 bar**

NEW







Kit para sustituir el bidet / Kit to replace the bidet / Kit d'hygiène pour remplacer le bidet / Kit igienico per sostituire il bidet  
TAUS



TESTED

### TAUS

**Kit mezclador para bidet. Monomando fabricado en latón estampado que garantiza la ausencia de porosidades y filtraciones de agua. Flexo con estructura interna extra reforzada. Apto para instalar a ambos lados del WC. Ducha pulsante de cierre de latón.**  
Bidet Mixer Kit. Single lever bidet mixer manufactured in stamping brass that guarantees the total absence of porosity and water filtrations. Flexible hose extra reinforced with internal structure. Suitable to install on both sides of WC. Hand shower with open/close pushbutton in brass.

Kit mélangeur pour bidet. Mitigeur fabriqué en laiton imprimé qui garantit l'absence de porosité et de fuite d'eau. Flexible avec structure interne extra renforcée. Habilité pour une installation des deux côtés des WC. Douchette à poussoir en laiton.

Kit miscelatore per bidet. Miscelatore monocomando realizzato in ottone stampato che garantisce l'assenza di porosità e perdite d'acqua. Flexibile con struttura interna extra rinforzata. Adatto per l'installazione su entrambi i lati del WC. Doccetta di chiusura pulsante in ottone.

Cromo / Chrome / Chromé / Cromato

34TAU0010120 8,7 l/min 3 bar

Negro / Black / Noir / Nero

34TAU0010520 8,7 l/min 3 bar

NEW

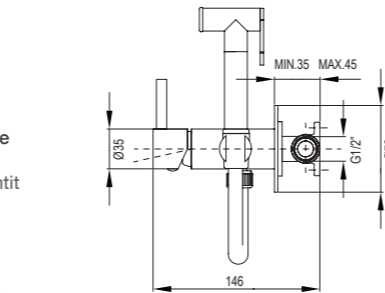

TESTED

### FLIX

**Kit mezclador para bidet. Monomando fabricado en latón estampado que garantiza la ausencia de porosidades y filtraciones de agua. Flexo con estructura interna extra reforzada. Apto para instalar a ambos lados del WC. Ducha pulsante de cierre de ABS cromado.**  
Bidet Mixer Kit. Single lever bidet mixer manufactured in stamping brass that guarantees the total absence of porosity and water filtrations. Flexible hose extra reinforced with internal structure. Suitable to install on both sides of WC. Hand shower with open/close pushbutton in chromed ABS.

Kit mélangeur pour bidet. Mitigeur fabriqué en laiton imprimé qui garantit l'absence de porosité et de fuite d'eau. Flexible avec structure interne extra renforcée. Habilité pour une installation des deux côtés des WC. Douchette à poussoir en ABS chromé.

Kit miscelatore per bidet. Miscelatore monocomando realizzato in ottone stampato che garantisce l'assenza di porosità e perdite d'acqua. Flexibile con struttura interna extra rinforzata. Adatto per l'installazione su entrambi i lati del WC. Doccetta di chiusura pulsante in ABS cromato.



TESTED

34FLI0010120 8,7 l/min 3 bar

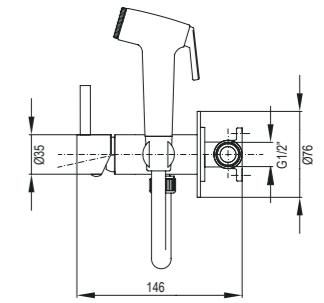

**Accesorio toallero de 17 cm compatible con todos los kits para sustituir el bidet. Se puede colocar a izquierda o derecha.**

Towel bar 17 cm length accessory suitable with all kits to replace the bidet. It can be installed on the left or the right side.

Porte-serviettes accessoire de 17 cm compatible avec tous les kits d'hygiène pour remplacer le bidet. Peut être placé à gauche ou à droite. Portasciugamani accessorio 17 cm compatibile con tutti i kit igienici per sostituire il bidet. Può essere posizionato a sinistra o destra.

Cromo / Chrome / Chromé / Cromato

31KIT1401

Negro / Black / Noir / Nero

31KIT1501

NEW

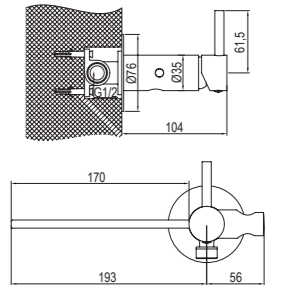



#### FLIX

**Conjunto higienico de un agua. Permite cortar independientemente el suministro de agua a la ducha y al tanque del inodoro. La llave de escuadra del inodoro puede ser fácilmente sustituida por este artículo. Ducha pulsante de cierre de ABS cromado.**  
Cold water hygienic set. Allows to cut off the water supply to the hand shower and to the water tank independently. The angle valve of the toilet can be easily replaced by this article. Hand shower with open/close pushbutton in chromed ABS.  
Kit hygiénique d'eau froide. Permet de couper de manière indépendante l'alimentation de l'eau à la douche et au réservoir de la toilette. Le robinet d'arrêt de la toilette peut être remplacé facilement par cet article. Douchette à poussoir en ABS chromé.  
Set igienico di acqua fredda. Permette di chiudere autonomamente la fornitura di acqua alla doccia e al serbatoio del bagno. Il rubinetto di chiusura della toilette può essere facilmente sostituito da questo articolo. Doccetta di chiusura pulsante in ABS cromato.

34FLI0020130



#### TAUS

**Conjunto higienico de un agua. Permite cortar independientemente el suministro de agua a la ducha y al tanque del inodoro. La llave de escuadra del inodoro puede ser fácilmente sustituida por este artículo. Ducha pulsante de cierre de latón cromado.**  
Cold water hygienic set. Allows to cut off the water supply to the hand shower and to the water tank independently. The angle valve of the toilet can be easily replaced by this article. Hand shower with open/close pushbutton in chromed brass.  
Kit hygiénique d'eau froide. Permet de couper de manière indépendante l'alimentation de l'eau à la douche et au réservoir de la toilette. Le robinet d'arrêt de la toilette peut être remplacé facilement par cet article. Douchette à poussoir en laiton chromé.  
Set igienico di acqua fredda. Permette di chiudere autonomamente la fornitura di acqua alla doccia e al serbatoio del bagno. Il rubinetto di chiusura della toilette può essere facilmente sostituito da questo articolo. Doccetta di chiusura pulsante in ottone cromato.

34TAU0020120



#### FLIX

**Kit con ducha compuesto por ducha pulsante de cierre, flexo super reforzado de 1,20 m y soporte. Ducha pulsante de cierre de ABS cromado.**  
Shattaf handset composed of open/close pushbutton hand shower, 1.20 m super reinforced flexible hose and wall bracket. Hand shower with open/close pushbutton in chromed ABS.  
Kit douchette composé d'une douchette à poussoir, d'un flexible extra renforcé de 1,20 m et d'un support fixe. Douchette à poussoir en ABS chromé.  
Set con docceta composto per doccetta di chiusura pulsante in ABS, flessibile extra rinforzato da 1,20 m, e supporto fisso. Doccetta di chiusura pulsante in ABS cromato.

34FLI0030140



#### TAUS

**Kit con ducha compuesto por ducha pulsante de cierre, flexo super reforzado de 1,20 m y soporte. Ducha pulsante de cierre de latón cromado.**  
Shattaf handset composed of open/close pushbutton hand shower, 1.20 m super reinforced flexible hose and wall bracket. Hand shower with open/close pushbutton in chromed brass.  
Kit douchette composé d'une douchette à poussoir, d'un flexible extra renforcé de 1,20 m et d'un support fixe. Douchette à poussoir en laiton chromé.  
Set con docceta composto per doccetta di chiusura pulsante, flessibile extra rinforzato da 1,20 m, e supporto fisso. Doccetta di chiusura pulsante in ottone cromato.

34TAU0030140



#### FLIX

**Ducha pulsante de cierre de ABS cromado.**  
Hand shower with open/close pushbutton in chromed ABS.  
Douchette à poussoir en ABS chromé.  
Doccetta di chiusura pulsante in ABS cromato.

34FLI0040125



#### TAUS

**Ducha pulsante de cierre de latón cromado.**  
Hand shower with open/close pushbutton in chromed brass.  
Douchette à poussoir en laiton chromé.  
Doccetta di chiusura pulsante in ottone cromato.

34TAU0040125

#### CONJUNTO LIMPIAINODOROS / HYGIENE SHOWER SET KITS DOUCHETTES POUR LES TOILETTES / SET DOCCIA PER SERVIZI IGIENICI



**Conjunto limpiainodoros blanco con te de enlace para acoplar a la llave de corte del inodoro.**  
WC kit with three ways intake connector to attach to the toilet angle valve, white.  
Kit douchette pour toilettes avec clé « T » à tube pour accoupler au robinet d'arrêt du toilette, blanc.  
Set doccia per la pulizia della toilette con connessione « T » per adattarsi alla chiave d'arresto del bagno, bianco.

34LIM0020330



**Conjunto limpiainodoros cromo con te de enlace para acoplar a la llave de corte del inodoro.**  
WC kit with three ways intake connector to attach to the toilet angle valve, chrome.  
Kit douchette pour toilettes avec clé « T » à tube pour accoupler au robinet d'arrêt du toilette, chromé.  
Set doccia per la pulizia della toilette con connessione « T » per adattarsi alla chiave d'arresto del bagno, cromato.

34LIM0020130



Conjunto higienico / Hygienic set / Kit hygiénique / Set igienico  
FLIX



**GRIFERÍA DE COCINA**  
**KITCHEN FAUCETS**  
**ROBINETTERIE DE CUISINE**  
**RUBINETTERIA DA CUCINA**

GRIFERÍA DE COCINA  
KITCHEN FAUCETS



**SORT**

**Monomando fregadera con ducha extraíble**  
Single lever pull-out kitchen faucet  
Mitigeur d'évier avec douchette  
Miscelatore per lavello con doccetta

05SOR510CR 5,4 l/min 3 bar

**NEW**  
Disponibile: Mayo 2022 / Available: May 2022  
Disponibile: Mai 2022 / Disponibile: Maggio 2022

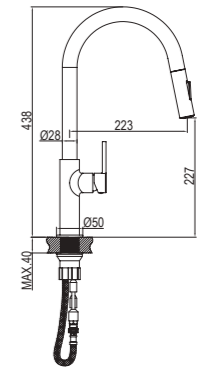

**ALPHA**

**Monomando fregadera con ducha extraíble**  
Single lever pull-out kitchen faucet  
Mitigeur d'évier avec douchette  
Miscelatore per lavello con doccetta

05SOA510CR 5,4 l/min 3 bar

**NEW**  
Disponibile: Mayo 2022 / Available: May 2022  
Disponibile: Mai 2022 / Disponibile: Maggio 2022

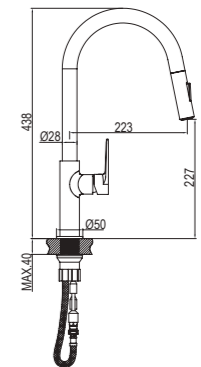

**SORT**

**Monomando fregadera**  
Single lever kitchen faucet  
Mitigeur d'évier  
Miscelatore per lavello

05SOR500CR 9,6 l/min 3 bar

**NEW**  
Disponibile: Mayo 2022 / Available: May 2022  
Disponibile: Mai 2022 / Disponibile: Maggio 2022

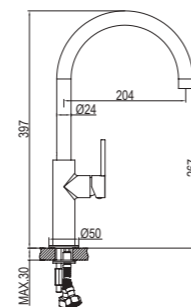

**ALPHA**

**Monomando fregadera**  
Single lever kitchen faucet  
Mitigeur d'évier  
Miscelatore per lavello

05SOA500CR 9,6 l/min 3 bar

**NEW**  
Disponibile: Mayo 2022 / Available: May 2022  
Disponibile: Mai 2022 / Disponibile: Maggio 2022

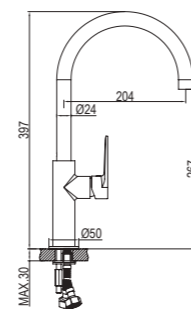



**SORT**

**Monomando fregadera**  
Single lever kitchen faucet  
Mitigeur d'évier  
Miscelatore per lavello

05SOR500NG  9,6 l/min 3 bar

**NEW**

Disponibile: Mayo 2022 / Available: May 2022  
Disponibile: Mai 2022 / Disponibile: Maggio 2022

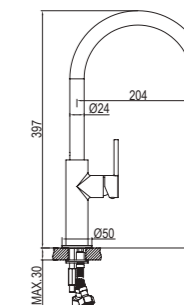

**ALPHA**

**Monomando fregadera**  
Single lever kitchen faucet  
Mitigeur d'évier  
Miscelatore per lavello

05SOA500NG  9,6 l/min 3 bar

**NEW**

Disponibile: Mayo 2022 / Available: May 2022  
Disponibile: Mai 2022 / Disponibile: Maggio 2022

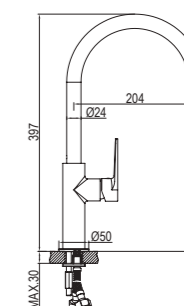

**SORT**

**Monomando fregadera con ducha extraible**  
Single lever pull-out kitchen faucet  
Mitigeur d'évier avec douchette  
Miscelatore per lavello con doccetta

05SOR510NG  5,4 l/min 3 bar

**NEW**

Disponibile: Mayo 2022 / Available: May 2022  
Disponibile: Mai 2022 / Disponibile: Maggio 2022

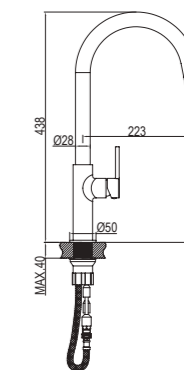

**ALPHA**

**Monomando fregadera con ducha extraible**  
Single lever pull-out kitchen faucet  
Mitigeur d'évier avec douchette  
Miscelatore per lavello con doccetta

05SOA510NG  5,4 l/min 3 bar

**NEW**

Disponibile: Mayo 2022 / Available: May 2022  
Disponibile: Mai 2022 / Disponibile: Maggio 2022

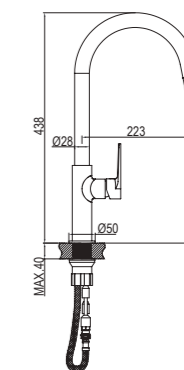



**ONE**

**Monomando fregadera**  
Single lever kitchen faucet  
Mitigeur d'évier  
Miscelatore per lavello

05ONE500CR 7,9 l/min 3 bar

**NEW**

Disponibile: Mayo 2022 / Available: May 2022  
Disponibile: Mai 2022 / Disponibile: Maggio 2022

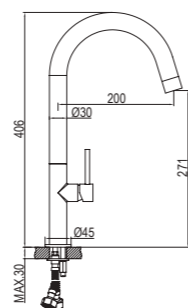

**ONE**

**Monomando fregadera con ducha extraible**  
Single lever pull-out kitchen faucet  
Mitigeur d'évier avec douchette  
Miscelatore per lavello con doccia

05ONE510CR 6,0 l/min 3 bar

**NEW**

Disponibile: Mayo 2022 / Available: May 2022  
Disponibile: Mai 2022 / Disponibile: Maggio 2022

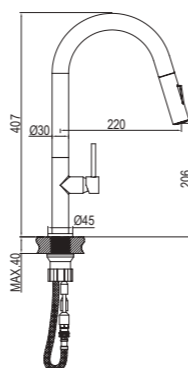



**B-COOK**

Monomando fregadera de caño flexible negro, cromo  
Single lever kitchen faucet, black flexible spout, chrome  
Mitigeur d'évier, bec haut flexible noir, chromé  
Miscelatore per lavello flessibile nero, cromato

05BCO500NC 6,3 l/min 3 bar

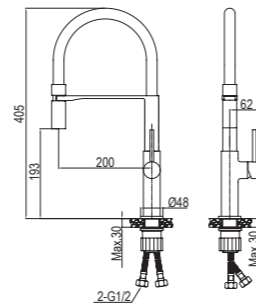

**ALPHA**

Monomando fregadera de caño flexible negro, cromo  
Single lever kitchen faucet, black flexible spout, chrome  
Mitigeur d'évier, bec haut flexible noir, chromé  
Miscelatore per lavello flessibile nero, cromato

05BCA500NC 6,3 l/min 3 bar

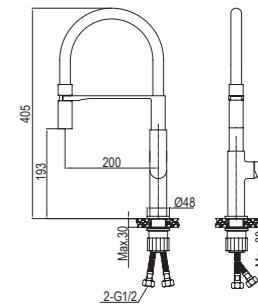

**ALPHA**

Monomando fregadera de caño flexible negro, cromo/negro mate  
Single lever kitchen faucet, black flexible spout, chrome/black matt  
Mitigeur d'évier, bec haut flexible noir, chromé/noir mat  
Miscelatore per lavello flessibile nero, cromato/nero opaco

05BCA500NG 6,3 l/min 3 bar

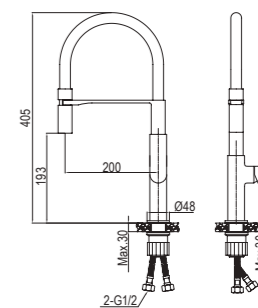

**TUBE**

Monomando fregadera de caño flexible negro, cromo  
Single lever kitchen faucet, black flexible spout, chrome  
Mitigeur d'évier, bec haut flexible noir, chromé  
Miscelatore per lavello flessibile nero, cromato

05BCT500NC 6,3 l/min 3 bar

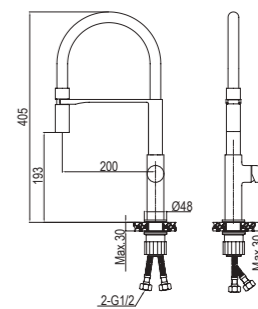

**TUBE**

Monomando fregadera de caño flexible negro, cromo/negro mate  
Single lever kitchen faucet, black flexible spout, chrome/black matt  
Mitigeur d'évier, bec haut flexible noir, chromé/noir mat  
Miscelatore per lavello flessibile nero, cromato/nero opaco

05BCT500NG 6,3 l/min 3 bar

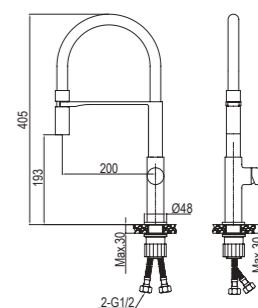



**COOK**

Monomando fregadera de caño muelle, cromo  
Single lever kitchen faucet, spring spout, chrome  
Mitigeur d'évier à ressort, chromé  
Miscelatore per lavello à molle, cromato

05COO500CR 8,3 l/min 3 bar

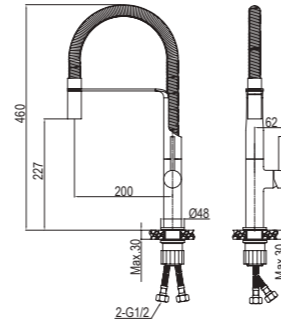

**ALPHA**

Monomando fregadera de caño muelle, cromo  
Single lever kitchen faucet, spring spout, chrome  
Mitigeur d'évier à ressort, chromé  
Miscelatore per lavello à molle, cromato

05COA500CR 8,3 l/min 3 bar

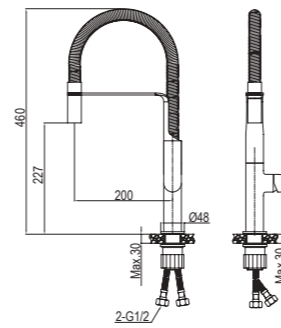

**TUBE**

Monomando fregadera de caño muelle, cromo  
Single lever kitchen faucet, spring spout, chrome  
Mitigeur d'évier à ressort, chromé  
Miscelatore per lavello à molle, cromato

05COT500CR 8,3 l/min 3 bar

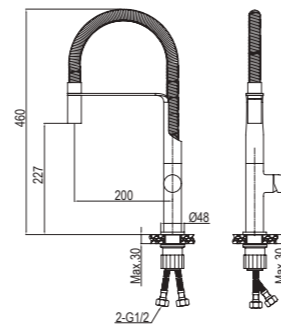





### METROPOL L

Monomando fregadera  
Single lever kitchen faucet  
Mitigeur d'évier  
Miscelatore per lavello

05MEL500CR 10,8 l/min 3 bar

05MEL501CR **2P** 6,7-10,8 l/min 3 bar

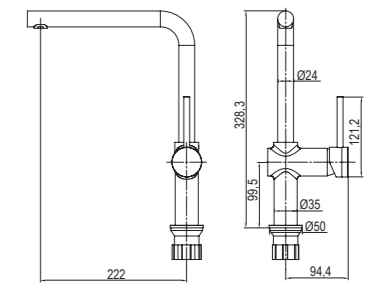

### METROPOL F

Monomando fregadera  
Single lever kitchen faucet  
Mitigeur d'évier  
Miscelatore per lavello

05MEF500CR 9,2 l/min 3 bar

05MEF509CR **5** l/min 3 bar

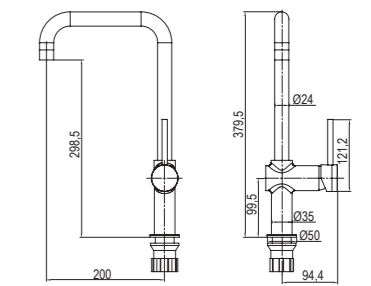

### METROPOL S

Monomando fregadera  
Single lever kitchen faucet  
Mitigeur d'évier  
Miscelatore per lavello

05MES500CR 18,5 l/min 3 bar

05MES509CR **5** l/min 3 bar

05MES501CR **2P** 6,3-15,8 l/min 3 bar

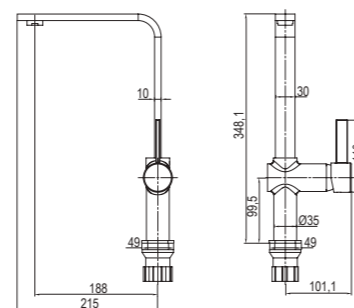

### ALPHA

Monomando fregadera  
Single lever kitchen faucet  
Mitigeur d'évier  
Miscelatore per lavello

05MTA500CR 18,5 l/min 3 bar

05MTA509CR **5** l/min 3 bar

05MTA501CR **2P** 6,3-15,8 l/min 3 bar

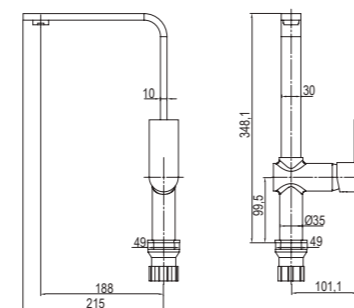



**INOX DUO**

Monomando fregadera, osmosis, de tres vías, acero satinado \*  
Single lever kitchen faucet, osmosis, 3 ways, brushed steel \*  
Mitigeur d'évier, système d'osmose à 3 voies, en acier satiné \*  
Miscelatore per lavello, sistema di osmosi a 3 vie, acciaio satinato \*

05DUO560IS 12,25 l/min 3 bar - 8,7 l/min 3 bar

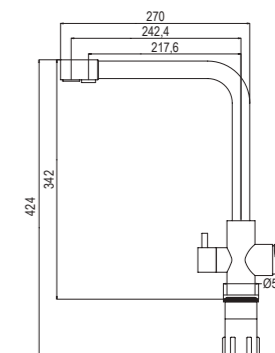

\* Para sistema de filtración consultar página 288 / For filtration system view page 288

\* Pour système de filtration et traitement de l'eau consultez page 288 / Per sistema di filtrazione e trattamento dell'acqua vedi pagina 288



GRIFERÍA DE COCINA  
KITCHEN FAUCETS



**INOX FAN**

Monomando fregadera extraíble, acero satinado  
Single lever pull-out kitchen faucet, brushed steel  
Mitigeur d'évier, extractible, en acier satiné  
Miscelatore per lavello, estraibile, acciaio satinato

05FAN510IS 5,8 l/min 3 bar

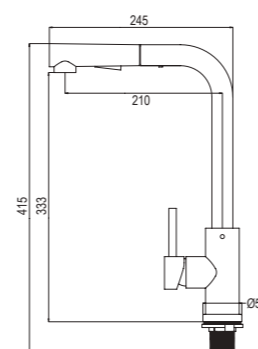



LIBRE DE PLOMO



LEAD FREE

### INOX LITE

**Monomando fregadera, acero satinado**  
 Single lever kitchen faucet, brushed steel  
 Mitigeur d'évier, en acier satiné  
 Miscelatore per lavello, acciaio satinato

05LIT500IS 14,3 l/min 3 bar

05LIT501IS  6,7-11,7 l/min 3 bar

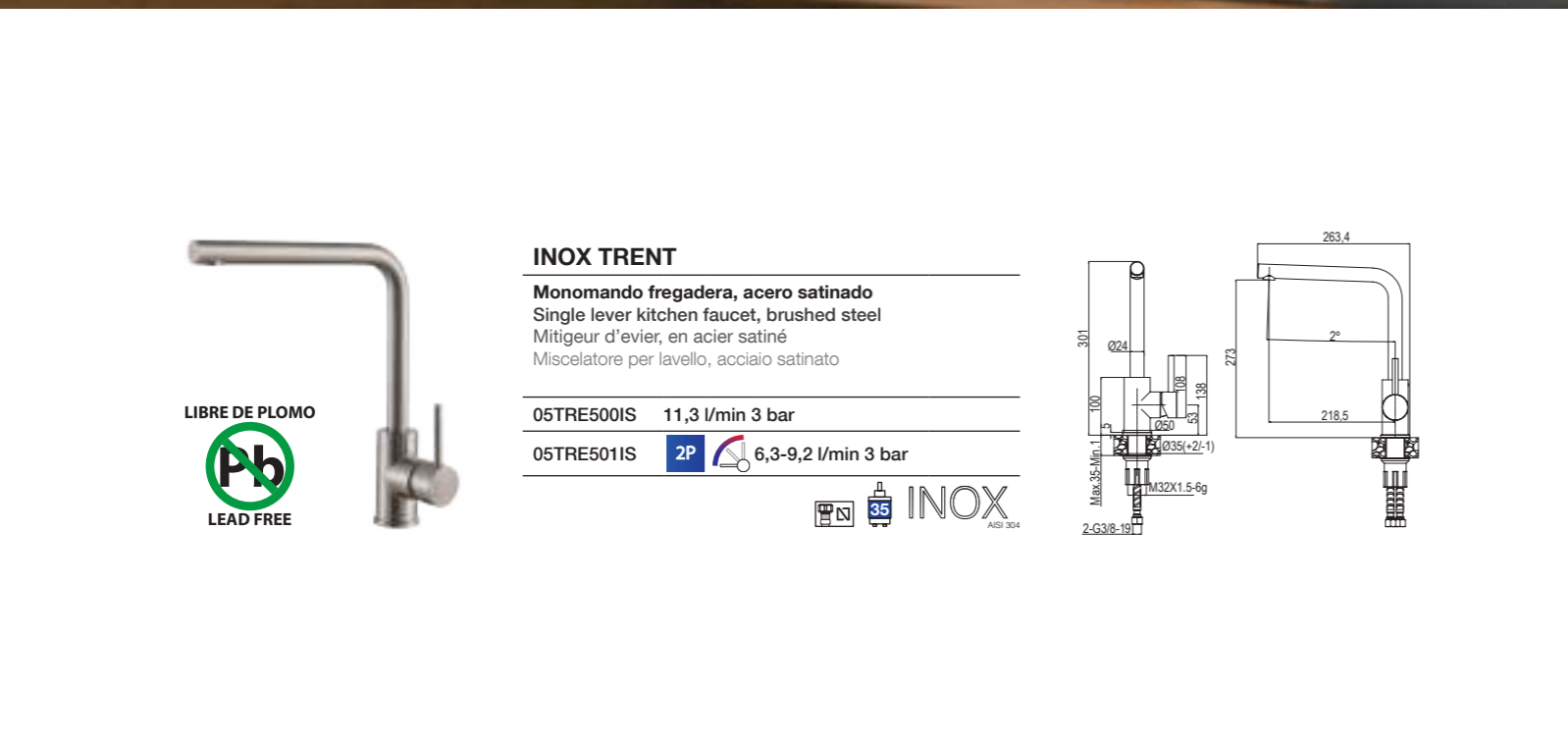
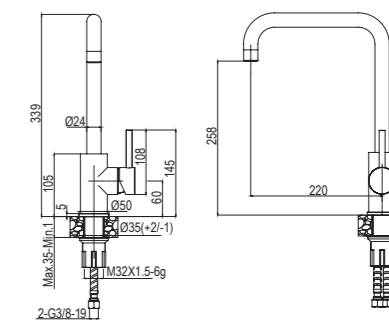

LIBRE DE PLOMO



LEAD FREE

### INOX TRENT

**Monomando fregadera, acero satinado**  
 Single lever kitchen faucet, brushed steel  
 Mitigeur d'évier, en acier satiné  
 Miscelatore per lavello, acciaio satinato

05TRE500IS 11,3 l/min 3 bar

05TRE501IS  6,3-9,2 l/min 3 bar

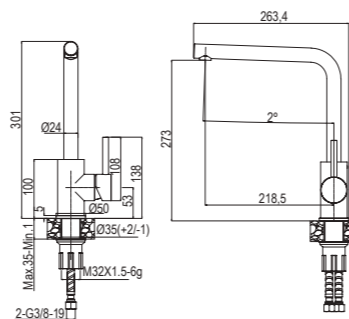

GRIFERÍA DE COCINA  
 KITCHEN FAUCETS

**WOLOBBY**

**Monomando fregadera y caño flexible con aireador de dos posiciones**  
 Single lever kitchen faucet, flexible spout with two functions aerator  
 Mitigeur d'évier, bec flexible avec aérateur de deux fonctions  
 Miscelatore per lavello, collo flessibile con aeratore a due funzioni

8,3 l/min 3 bar



**Acabado blanco/cromo**  
 White/chrome finish  
 Finition blanc/chromé  
 Finitura bianca/cromata

05WOL570BL



**Acabado negro/cromo**  
 Black/chrome finish  
 Finition blanc/chromé  
 Finitura bianca/cromata

05WOL570NG



**Acabado gris/cromo**  
 Grey/chrome finish  
 Finition gris/chromé  
 Finitura grigia/cromata

05WOL570GR

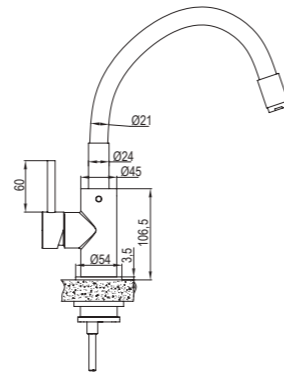



GRIFERÍA DE COCINA  
 KITCHEN FAUCETS



**COLORS**

**Monomando fregadera, acabado blanco/cromo**  
 Single lever kitchen faucet, white/chrome finish  
 Mitigeur d'évier, finition blanc/chromé  
 Miscelatore per lavello, finitura bianca/cromata

05COL500BL 10,0 l/min 3 bar

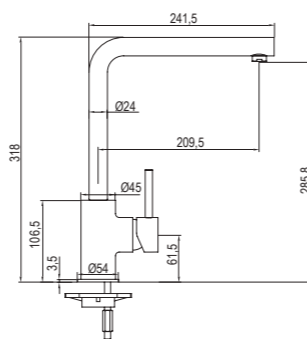

**COLORS**

**Monomando fregadera, acabado negro/cromo**  
 Single lever kitchen faucet, black/chrome finish  
 Mitigeur d'évier, finition noir/chromé  
 Miscelatore per lavello, finitura nera/cromata

05COL500NG 10,0 l/min 3 bar

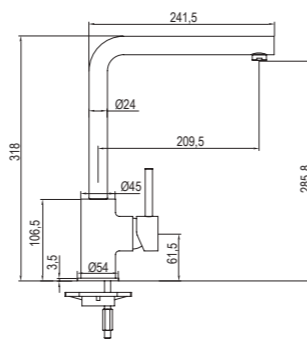



### COLORS

**Monomando fregadera, acabado cromo**  
Single lever kitchen faucet, chrome finish  
Mitigeur d'évier, finition chromé  
Miscelatore per lavello, finitura cromata

05COL500CR 10,0 l/min 3 bar

NEW

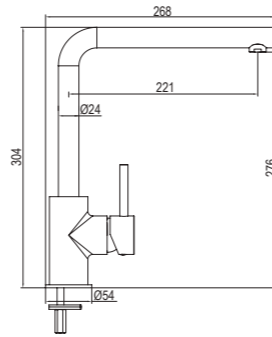

### LILE

**Monomando fregadera**  
Single lever kitchen faucet  
Mitigeur d'évier  
Miscelatore per lavello

05LIL500CR 19,8 l/min 3 bar

05LIL509CR 5 l/min 3 bar

05LIL501CR 2P 6,5-13,2 l/min 3 bar

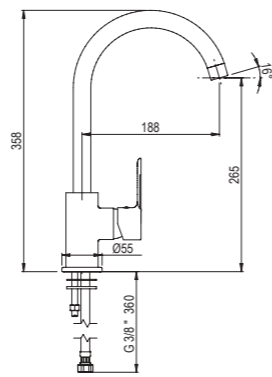

### BETA

**Monomando fregadera**  
Single lever kitchen faucet  
Mitigeur d'évier  
Miscelatore per lavello

05MIB500CR 19,8 l/min 3 bar

05MIB509CR 5 l/min 3 bar

05MIB501CR 2P 6,5-13,2 l/min 3 bar

NEW

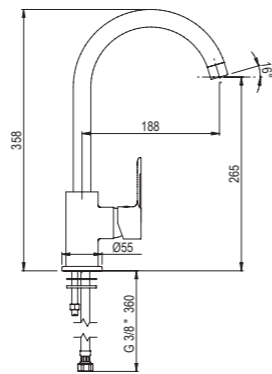

### VENT-i2

**Monomando fregadera**  
Single lever kitchen faucet  
Mitigeur d'évier  
Miscelatore per lavello

05MIV500CR 19,8 l/min 3 bar

05MIV509CR 5 l/min 3 bar

05MIV501CR 2P 6,5-13,2 l/min 3 bar

NEW

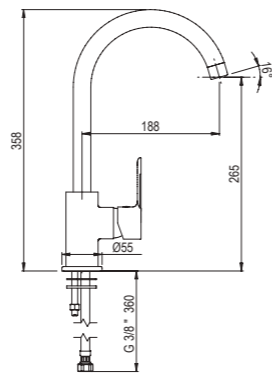



### MINIMALISTA

**Monomando fregadera**  
Single lever kitchen faucet  
Mitigeur d'évier  
Miscelatore per lavello

- 05MIN500CR 19,8 l/min 3 bar
- 05MIN509CR 5 l/min 3 bar
- 05MIN501CR 2P 6,3-13,2 l/min 3 bar

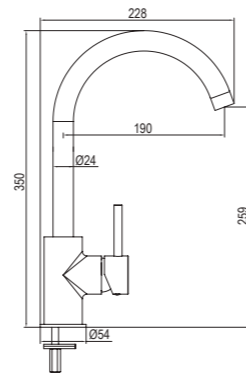

### SKY

**Monomando fregadera**  
Single lever kitchen faucet  
Mitigeur d'évier  
Miscelatore per lavello

- 05SKY505CR 13,5 l/min 3 bar
- 05SKY509CR 5 l/min 3 bar

NEW

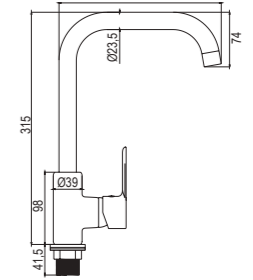

### SKY

**Monomando fregadera**  
Single lever kitchen faucet  
Mitigeur d'évier  
Miscelatore per lavello

- 05MIS500CR 19,8 l/min 3 bar
- 05MIS509CR 5 l/min 3 bar
- 05MIS501CR 2P 6,5-13,2 l/min 3 bar

NEW

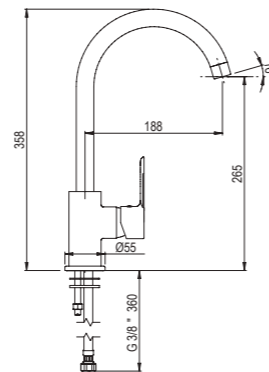

### SCAPE

**Monomando fregadera**  
Single lever kitchen faucet  
Mitigeur d'évier  
Miscelatore per lavello

- 05SCA500CR 13,7 l/min 3 bar

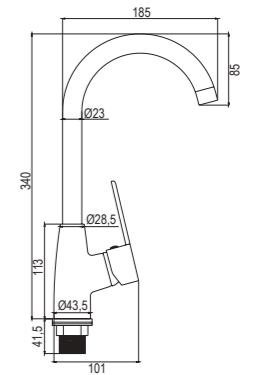

### VANCOUVER

**Monomando fregadera**  
Single lever kitchen faucet  
Mitigeur d'évier  
Miscelatore per lavello

- 05VAN500CR 15,4 l/min 3 bar

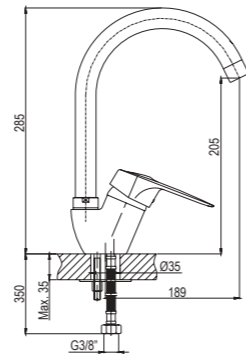

### TILE

**Monomando fregadera abatible, 8cm de altura con la maneta y el caño totalmente abatido. Cartucho de apertura en frío.**  
Single lever kitchen faucet, foldable, high spout, 8 cm of height with lever and spout totally folded. Cold opening cartridge.  
Mitigeur d'évier, bec haut, pliant, 8 cm de hauteur avec le levier et le bec complètement plié.  
Cartouche d'ouverture à froid.  
Miscelatore per lavello, pieghevole, 8 cm di altezza con la leva e il collo collo reclinabile. Cartuccia di apertura a freddo.

- 05TIL500CR 13,2 l/min 3 bar

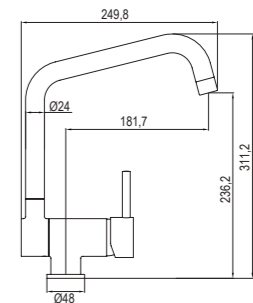

### DYNAMO

**Monomando fregadera**  
Single lever kitchen faucet  
Mitigeur d'évier  
Miscelatore per lavello

- 05DYN500CR 13,5 l/min 3 bar
- 05DYN509CR 5 l/min 3 bar

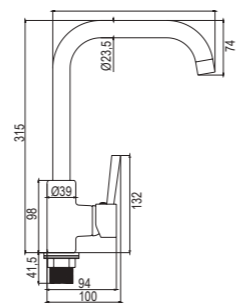

### GALA R

**Monomando fregadera de caño inclinado**  
Single lever kitchen faucet, slanted spout  
Mitigeur d'évier, bec incliné  
Miscelatore per lavello, collo inclinato

- 05GAL520CR 13,3 l/min 3 bar

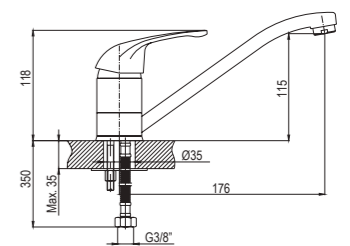



### LUFT V

**Monomando fregadera con ducha extraíble.**  
**Ducha de latón.**  
Single lever pull-out kitchen faucet.  
Hand shower in brass.  
Mitigeur d'évier avec douchette.  
Douchette en laiton.  
Miscelatore per lavello con doccetta.  
Doccetta di chiusura pulsante in ottone.

05LUF510CR 14,2 l/min 3 bar

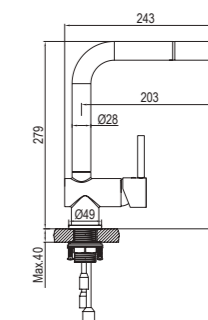

### GALA V

**Monomando fregadera con ducha extraíble**  
Single lever pull-out kitchen faucet  
Mitigeur d'évier avec douchette  
Miscelatore per lavello con doccetta

05GAL510CR 11,7 l/min 3 bar

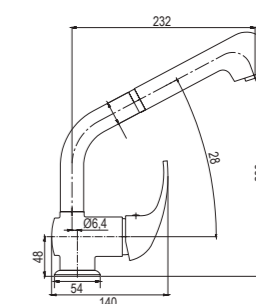

### GALA E

**Monomando fregadera con ducha extraíble de caño inclinado**  
Single lever pull-out kitchen faucet, slanted spout  
Mitigeur d'évier avec douchette, bec incliné  
Miscelatore per lavello con doccetta, collo inclinato

05GAL530CR 11,7 l/min 3 bar

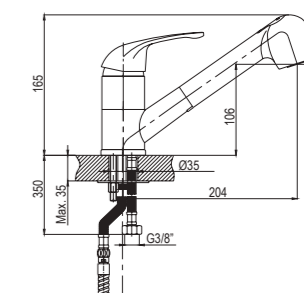





### TIMES

**Monomando de pared**  
Single lever wall mounted faucet  
Mitigeur d'évier mural  
Miscelatore per lavello a parete

05TIM540CR 15,0 l/min 3 bar

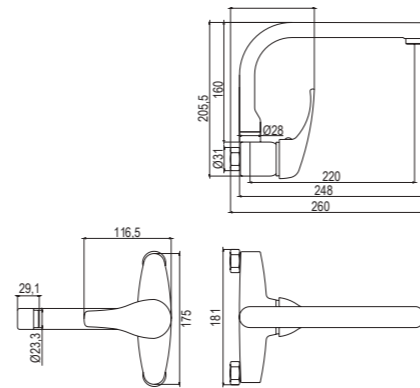

### MAYFAIR

**Bimando fregadera / Double handle kitchen faucet / Mélangeur d'évier / Miscelatore per lavello**



**COBRE / COPPER**  
CUIVRE / RAME

06MAY500CU



**BRONCE / BRONZE**  
BRONZE / BRONZO

06MAY500BR



**CROMO / CHROME**  
CHROMÉ / CROMATO

06MAY500CR

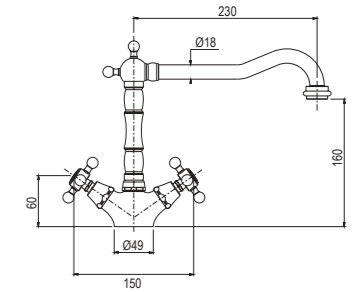

### CHRONOS

**Bimando fregadera / Double handle kitchen faucet / Mélangeur d'évier / Miscelatore per lavello**



### AQUEOS

**Grifo de pared**  
Wall mounted faucet  
Robinet d'évier mural  
Rubinetto per lavello a parete

06AQU540CR 16,7 l/min 3 bar

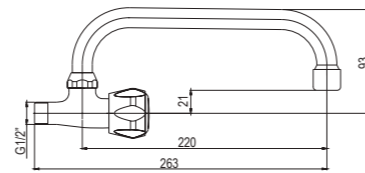

**BRONCE / BRONZE**  
BRONZE / BRONZO

06CHR500BR



**PLATA / SILVER**  
ARGENT / ARGENTO

06CHR500AG

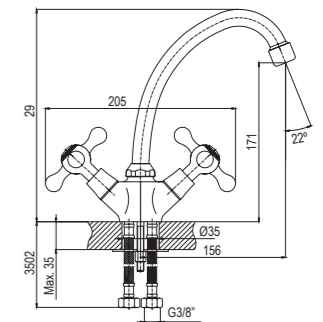

### ARGOS 110

**Bimando de pared con caño de 220 mm**  
Double handle wall mounted faucet, with spout  
220mm  
Mélangeur d'évier mural avec bec de 220 mm.  
Miscelatore per lavello a parete con collo di 220 mm.

06ARG540CR

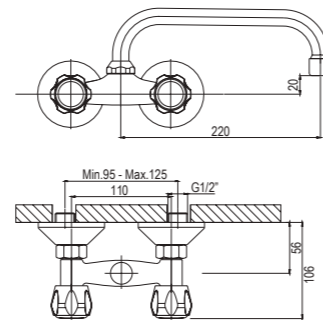

### RHODAS

**Bimando fregadera 150 / Double handle kitchen faucet 150 / Mélangeur d'évier 150 / Miscelatore per lavello 150**



**BRONCE / BRONZE**  
BRONZE / BRONZO

06RHO540BR



**CROMO / CHROME**  
CHROMÉ / CROMATO

06RHO540CR

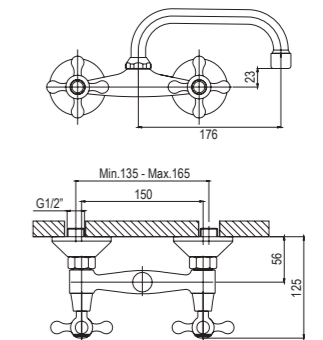

### HOMERO 150

**Bimando de pared con caño de 220 mm**  
Double handle wall mounted faucet, with spout  
220mm  
Mélangeur d'évier mural avec bec de 220 mm.  
Miscelatore per lavello a parete con collo di 220 mm.

06HOM540CR 25,0 l/min 3 bar

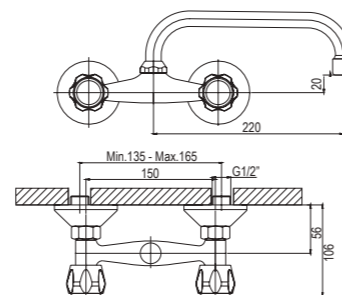

### ATHOS

**Bimando fregadera 110 / Double handle kitchen faucet 110 / Mélangeur d'évier 110 / Miscelatore per lavello 110**



**BRONCE / BRONZE**  
BRONZE / BRONZO

06ATH540BR



**CROMO / CHROME**  
CHROMÉ / CROMATO

06ATH540CR

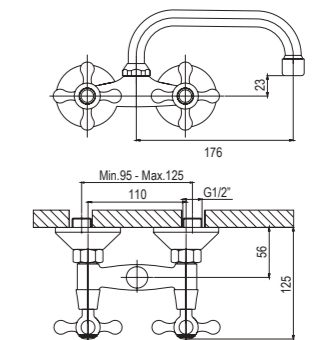



**LÓGICO AQUA**  
**Sistema de filtrado con kit completo de instalación**  
 Filter system with complete installation kit  
 Système de filtration avec kit d'installation complet  
 Sistema di filtrazione con kit di installazione completo

55001



**FILTER-MAX**  
**Sistema de filtrado con kit completo de instalación**  
 Filter system with complete installation kit  
 Système de filtration avec kit d'installation complet  
 Sistema di filtrazione con kit di installazione completo

55002



**LÓGICO AQUA**  
**Cartucho Carbón Block para sistema "Logico Aqua"**  
 Carbon Block cartridge for "Logico Aqua" system  
 Cartouche bloc de charbon pour système "Logico Aqua"  
 Cartuccia di carbone per sistema "Logico Aqua"

55101

Recambio  
 Refill  
 Remplacement  
 Ricambio



**FILTER-MAX**  
**Cartucho Rell Carbón para sistema "Filter-Max"**  
 Rell Carbon cartridge for "Filter-Max" system  
 Cartouche Rell Charbon pour système "Filter-Max"  
 Cartuccia Rell Carbone per sistema "Filter-Max"

55102

Recambio  
 Refill  
 Remplacement  
 Ricambio

Miembros Members Membres Membri	Consumo de agua ** Water consumption ** Consommation d'eau ** Consumo d'acqua **	LÓGICO AQUA 12.000 litros / liters litres / litri *	FILTER-MAX 4.000 litros / liters litres / litri *
Familia pequeña Small family Petite famille Piccola famiglia	4 litros / liters litres / litri	4 litros / liters litres / litri	4 litros / liters litres / litri
Familia mediana Medium-size family Famille moyenne Famiglia media	7 litros / liters litres / litri	7 litros / liters litres / litri	7 litros / liters litres / litri
Familia grande Large family Grande famille Grande famiglia	11 litros / liters litres / litri	11 litros / liters litres / litri	11 litros / liters litres / litri

\*\* Datos recogidos en bases a estadísticas generales  
 \*\* Data collected in general statistics databases  
 \*\* Données collectées dans des bases de données de statistiques générales  
 \*\* Dati ottenuti in database con statistiche generali

\*\*\* Se aconseja cambiar cada 12 meses por temas higiénicos  
 \*\*\* For hygienic reasons, a change every 12 months is recommended  
 \*\*\* Il est conseillé de changer tous les 12 mois pour des raisons d'hygiène  
 \*\*\* Si consiglia di cambiare ogni 12 mesi per motivi di igiene



**LIBRE DE PLOMO**  
**LEAD FREE**

**INOX DUO**  
**Monomando fregadera, osmosis, de tres vias, acero satinado \***  
 Single lever kitchen faucet, osmosis, 3 ways, brushed steel \*  
 Mitigeur d'évier, système d'osmose à 3 voies, en acier satiné \*  
 Miscelatore per lavello, sistema di osmosi a 3 vie, acciaio satinato \*

05DUO560IS 12,25 l/min 3 bar - 8,7 l/min 3 bar

INOX AISI 304

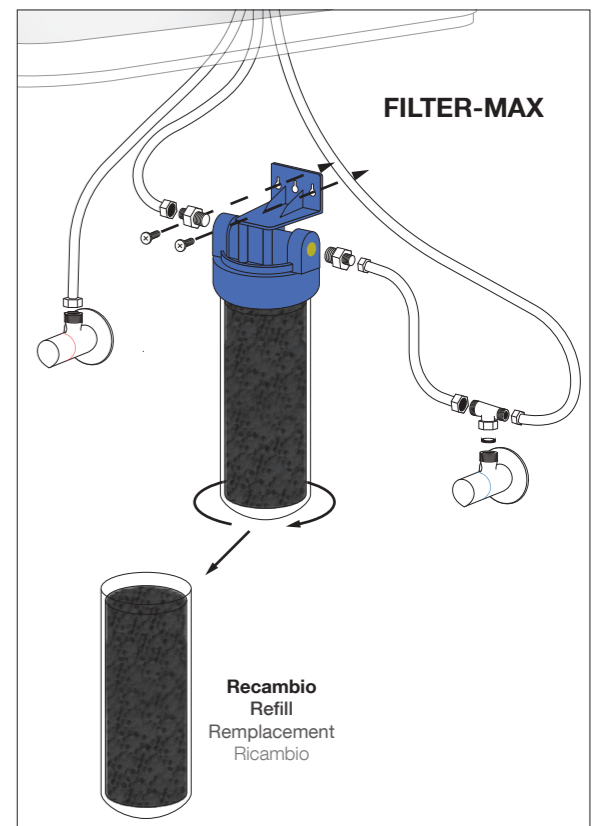
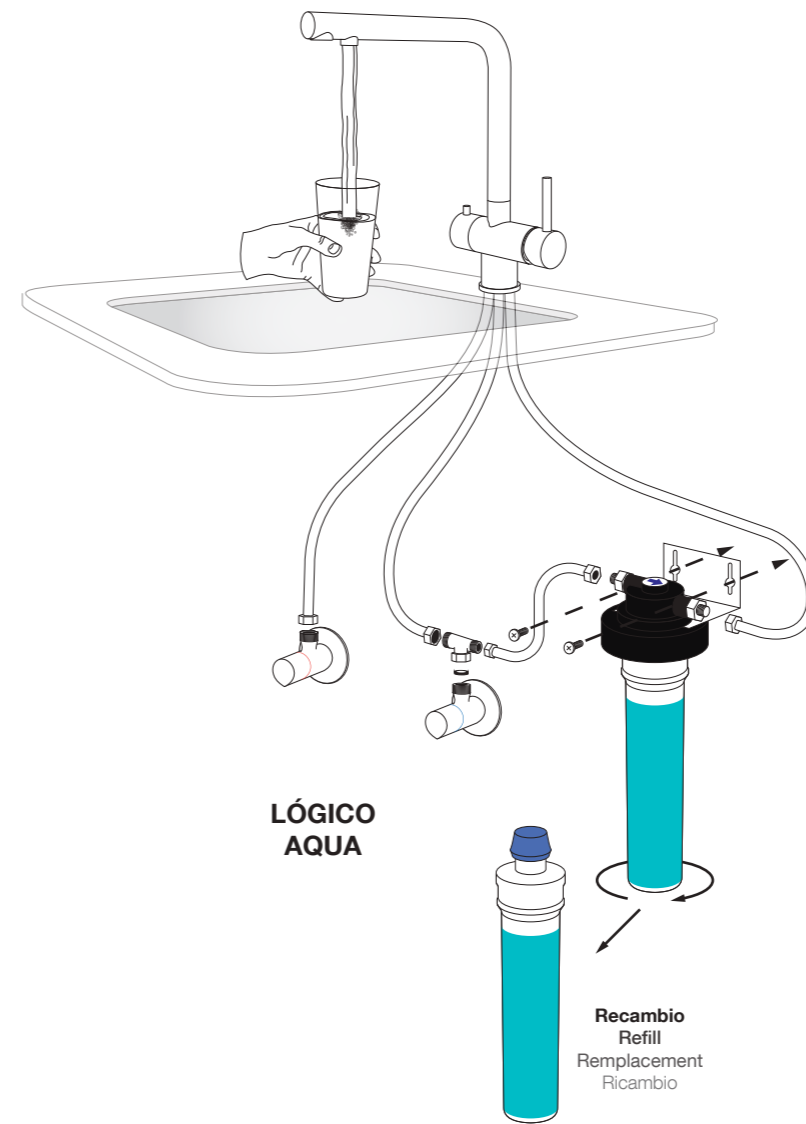
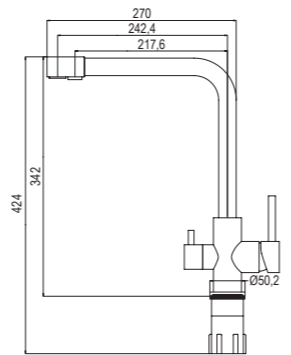

	LÓGICO AQUA	FILTER-MAX
<b>Certificación</b> Certification Certification Certificazione	Producto Certificado UNE 149101 de equipos de tratamiento de agua en el interior de edificios. Cumple con el Real Decreto 140/2003 y el Real Decreto 742/2013 UNE 149101 Certified Product for water treatment equipments in building interiors. Complies with Royal Decree 140/2003 and Royal Decree 742/2013 Produit Certifié UNE 149101 d'équipements de traitement de l'eau à l'intérieur de bâtiments. Conforme au Décret Royal 140/2003 et au Décret Royal 742/2013 Prodotto certificato UNE 149101 di apparecchiature per il trattamento dell'acqua all'interno degli edifici. In conformità con il Regio Decreto 140 / 2003 e il Regio Decreto 742 / 2013	Cumple con la legislación vigente Real Decreto 140/2003 Complies with the current legislation Royal Decree 140/2003 Respecte la législation en vigueur Décret Royal 140/2003 Rispetta la legislazione in vigore Regio Decreto 140/2003
<b>Filtración</b> Filtration Filtration FiltraZIONE	5µ	500µ
<b>Durabilidad</b> Lifetime Durabilità Durata	12.000 litros / liters / litres / litri	4.000 litros / liters / litres / litri
<b>Calidad</b> Quality Qualité Qualità	Fabricado en bloque de carbón activado de alto rendimiento a base de cáscara de coco Manufactured from coconut shells in high performance activated carbon block Fabriqué en bloc de carbone activé à haut rendement à base de coquille de noix de coco Realizzato in blocchi di carbone attivo con alta efficienza basata su guscio di noce di cocco	Carbón granulado activo de origen mineral Granular activated carbon of mineral origin Charbon actif granulé d'origine minérale Carbone attivo granulato di origine minerale
<b>Instalación</b> Installation Installazione	Súper fácil / super easy / super facile / super facil 	Súper fácil / super easy / super facile / super facil 

\* Capacidad de filtración según pruebas de laboratorio. Aguas de red con un nivel de turbidez inferior a 5 NTV y un valor de cloro entre 0,2 y 1 mg/L.  
 \* Filtration capacity according to test bench. Tap water system with a turbidity below 5 NTV and a chlorine value between 0,2 and 1 mg/L.  
 \* Capacité de filtration selon preuves de laboratoire. Eaux de réseau avec un niveau de turbidité inférieur à 5 NTV et une valeur de chlore entre 0,2 et 1 mg/L.  
 \* Capacità di filtrazione in base alle prove di laboratorio. Acque di rete con un livello di torbidità inferiore a 5 NTV e un valore di cloro compreso tra 0,2 e 1 mg / L.



**COLECTIVIDADES**  
**COLECTIVITIES**  
**COLLECTIVITÉS**  
**COLLETTIVITÀ**

**FUNCIONAMIENTO**  
FUNCTIONING  
FONCTIONNEMENT  
FUNZIONAMENTO

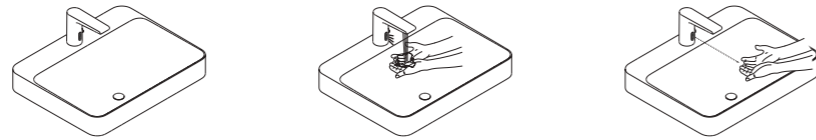

**OPCIONES DE CONEXIÓN**  
CONNECTION OPTIONS  
OPTIONS DE CONNEXION  
OPZIONI DI CONNESSIONE

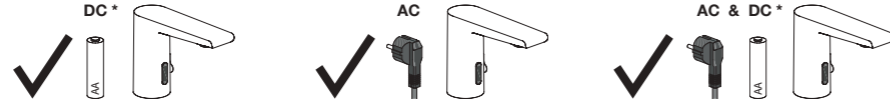

**STOP DE SEGURIDAD**  
SAFETY STOP  
ARRÊT DE SÉCURITÉ  
SOSTA DI SICUREZZA

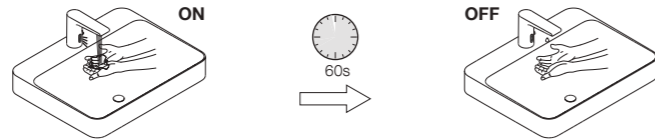

**AVISO CAMBIO DE BATERÍA**  
BATTERY CHANGE NOTICE  
NOTIFICATION BATTERIE FAIBLE  
AVVISO PER IL CAMBIO DELLA BATTERIA

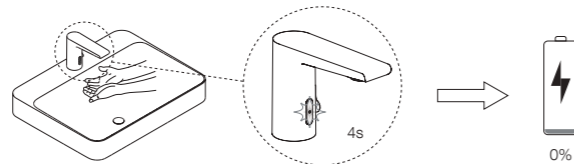

**FIJI ONE**

**Lavabo electrónico un agua, con aireador antivandálico, cromo**  
Cold water electronic faucet, with antivandalic aerator, chrome  
Lavabo électronique une eau, avec aérateur anti-vandalisme, chromé  
Rubinetto elettronico di un'acqua, con aeratore antivandalo, cromato

04FIJ100CR 15 l/min 3 bar

04FIJ108CR 5 l/min 3 bar

NEW

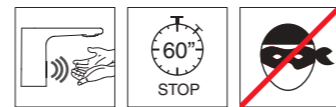
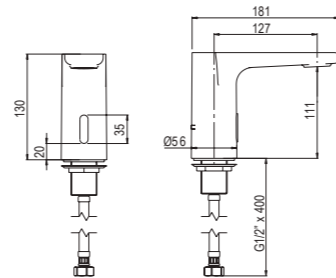
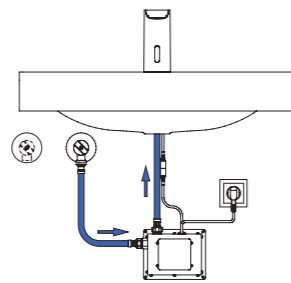

**FIJI MIX**

**Lavabo electrónico un agua con grifo mezclador bajo lavabo, con aireador antivandálico, cromo**  
Cold water electronic faucet with mixer tap hidden below the basin, with antivandalic aerator, chrome  
Lavabo électronique une eau avec robinet mélangeur dessous le lavabo, avec aérateur anti-vandalisme, chromé  
Rubinetto elettronico un'acqua con miscelatore sotto lavabo, con aeratore antivandalo, cromato

04FIJ180CR 8,3 l/min 3 bar

04FIJ188CR 5 l/min 3 bar

NEW

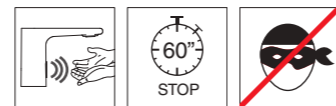
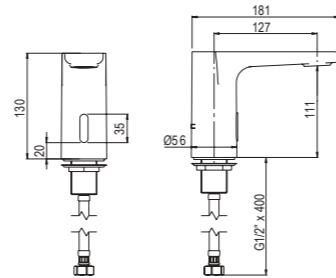
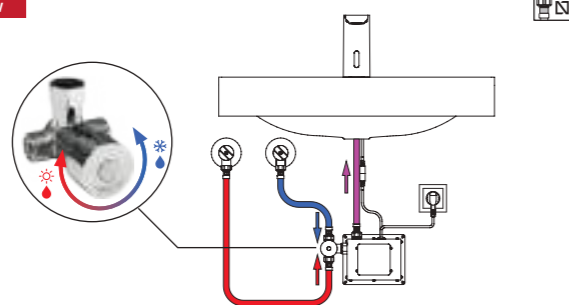

**FIJI ADVANCE**

**Lavabo electrónico mezclador con palanca lateral, con aireador antivandálico, cromo**  
Electronic mixer with lateral lever, with antivandalic aerator, chrome  
Lavabo électronique mélangeur avec levier latéral, avec aérateur anti-vandalisme, chromé  
Rubinetto elettronico miscelatore con leva laterale, con aeratore antivandalo, cromato

04FIJ110CR 7,5 l/min 3 bar

04FIJ118CR 5 l/min 3 bar

NEW

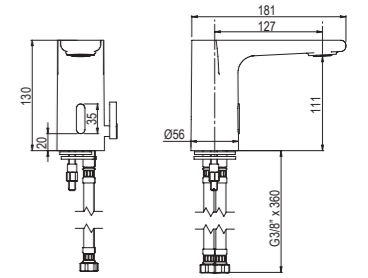
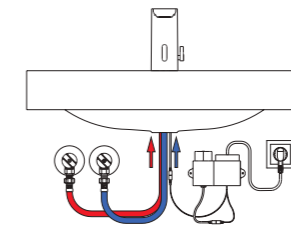
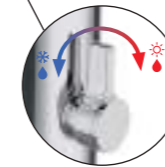

Grifo electrónico / Electronic bathroom faucet / Robinet électronique / Rubinetto elettronico  
FIJI ADVANCE

**FUNCIONAMIENTO**  
FUNCTIONING  
FONCTIONNEMENT  
FUNZIONAMENTO

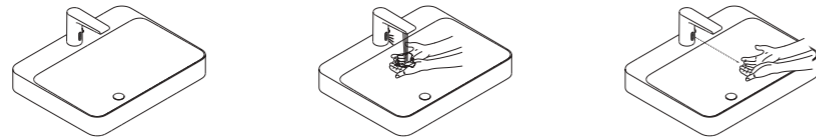

**OPCIONES DE CONEXIÓN**  
CONNECTION OPTIONS  
OPTIONS DE CONNEXION  
OPZIONI DI CONNESSIONE

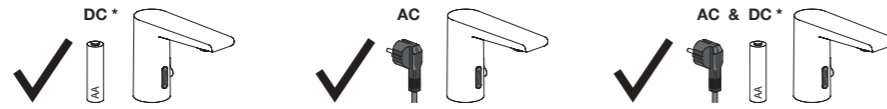

**STOP DE SEGURIDAD**  
SAFETY STOP  
ARRÊT DE SÉCURITÉ  
SOSTA DI SICUREZZA

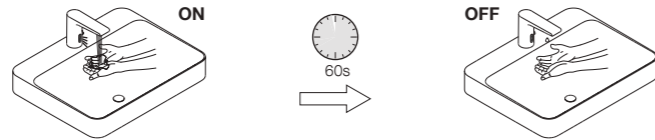

**AVISO CAMBIO DE BATERÍA**  
BATTERY CHANGE NOTICE  
NOTIFICATION BATTERIE FAIBLE  
AVVISO PER IL CAMBIO DELLA BATTERIA

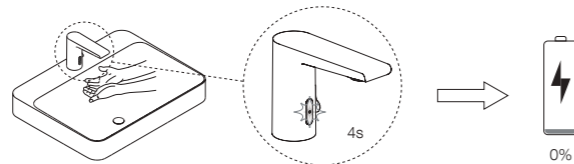

**SAMOA ONE**

Lavabo electrónico un agua, cromo  
Cold water electronic faucet, chrome  
Lavabo électronique une eau, chromé  
Rubinetto elettronico di un'acqua, cromato

04SAM100CR 15 l/min 3 bar

04SAM108CR 5 l/min 3 bar

NEW

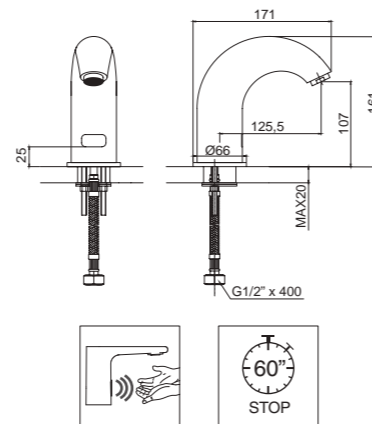
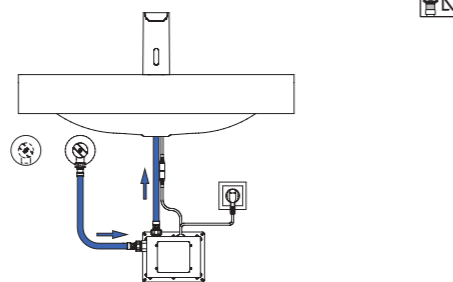

**SAMOA MIX**

Lavabo electrónico un agua con grifo mezclador bajo lavabo, cromo  
Cold water electronic faucet with mixer tap hidden below the basin, chrome  
Lavabo électronique une eau avec robinet mélangeur dessous le lavabo, chromé  
Rubinetto elettronico un'acqua con miscelatore sotto lavabo, cromato

04SAM180CR 8,3 l/min 3 bar

04SAM188CR 5 l/min 3 bar

NEW

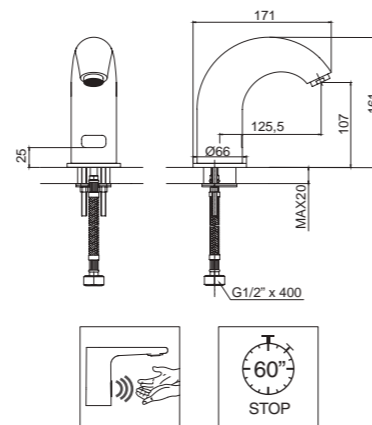
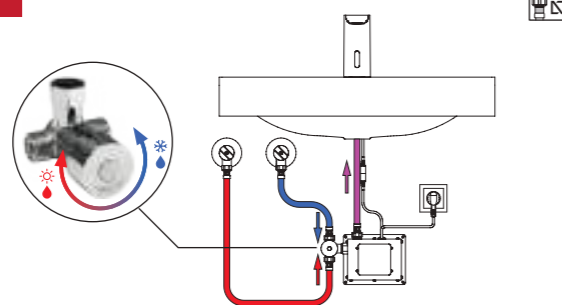

Grifo electrónico / Electronic bathroom faucet / Robinet électronique / Rubinetto elettronico  
SAMOA



### MED LA03

**Monomando de lavabo, cromo**  
Single lever basin faucet, chrome  
Mitigeur de lavabo, chromé  
Miscelatore per lavabo, cromato

01SKY104CR 10 l/min 3 bar

01SKY114CR 5 l/min 3 bar

NEW

Disponible: Marzo 2022 / Available: March 2022  
Disponibile: Mars 2022 / Disponibile: Marzo 2022

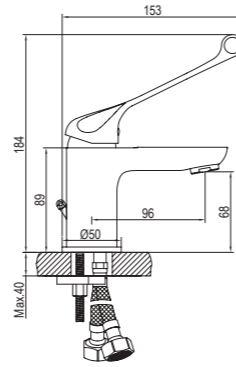

**Caño giratorio para grifo pedal**  
Swivel spout for foot valve  
Bec orientable pour robinet à pédale  
Collo manovrabile per rubinetto a pedale

07IND000CR

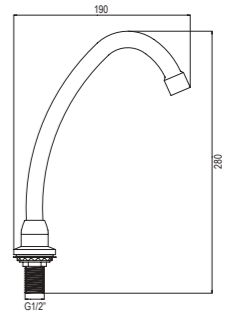

### MED LA04

**Monomando de lavabo, cromo**  
Single lever basin faucet, chrome  
Mitigeur de lavabo, chromé  
Miscelatore per lavabo, cromato

01LIL104CR 8,3 l/min 3 bar

01LIL114CR 5 l/min 3 bar

NEW

Disponible: Marzo 2022 / Available: March 2022  
Disponibile: Mars 2022 / Disponibile: Marzo 2022

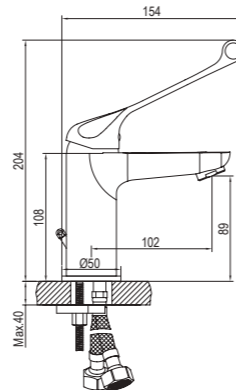

**Grifo dos pedales, montaje a suelo**  
Double foot valve, floor-mount  
Robinet à deux pédales, montage au sol  
Rubinetto a due pedali, montaggio a pavimento

07IND2PMCR 26 l/min 3 bar

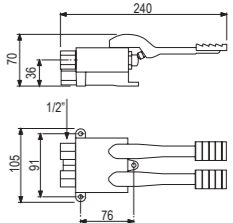

**Grifo pedal un agua, montaje a suelo**  
Single foot valve, floor-mount  
Robinet à pédale une seule eau, montage au sol  
Rubinetto a pedale singola acqua, montaggio a pavimento

07IND1P1CR 15 l/min 3 bar

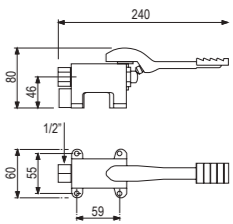

### MED FR01

**Monomando fregadera de caño inclinado**  
Single lever kitchen faucet, slanted spout  
Mitigeur d'évier, bec incliné  
Miscelatore per lavello, collo inclinato

05GAL524CR 13,3 l/min 3 bar

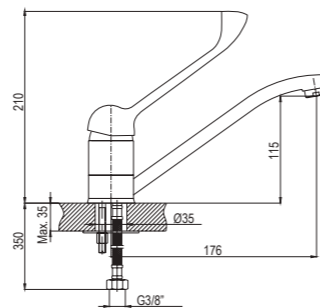

**Grifo pedal mezclador progresivo, montaje a suelo**  
Mixer foot valve, floor-mount  
Robinet à pédale, mélangeur progressif, montage au sol  
Rubinetto a pedale, miscelatore progressivo, montaggio a pavimento

07IND1PMCR 35 l/min 3 bar

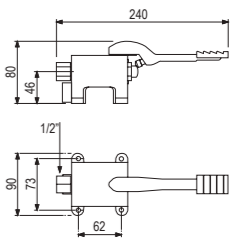

### MED FE01

**Monomando fregadera con ducha extraíble de caño inclinado**  
Single lever pull-out kitchen faucet, slanted spout  
Mitigeur d'évier avec douchette, bec incliné  
Miscelatore per lavello con doccia, collo inclinato

05GAL534CR 11,7 l/min 3 bar

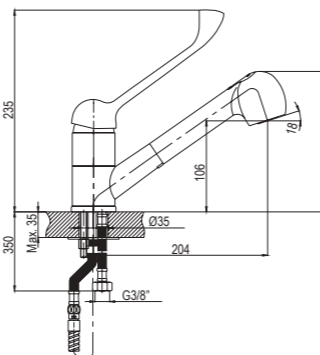

### NOMO

**Grifo de jardín, latón cromado**  
Garden faucet, chromed brass  
Robinet de jardin en laiton chromé  
Rubinetto da giardino in ottone cromato

08NOM1MCR40 24,1 l/min 3 bar

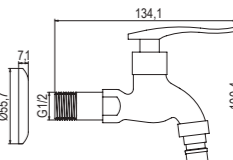



**COMPLEMENTOS DE GRIFERÍA**  
**FAUCET ACCESSORIES**  
**ACCESSOIRES POUR ROBINETTERIE**  
**ACCESSORI PER RUBINETTI**



### CUADRADO

**Sifón telescópico de lavabo, 1"1/4, latón cromado**  
Telescopic basin waste trap, 1"1/4, chromed brass  
Siphon télescopique de lavabo, 1"1/4, laiton chromé  
Sifone telescopico per lavabo, 1"1/4, ottone cromato

40S010125 **caja / box / boîte / scatola**

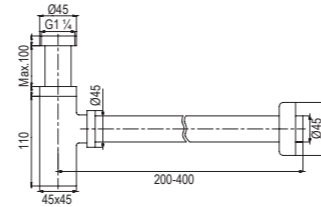

### MINIMALISTA

**Sifón telescópico de lavabo, 1"1/4, latón cromado**  
Telescopic basin waste trap, 1"1/4, chromed brass  
Siphon télescopique de lavabo, 1"1/4, laiton chromé  
Sifone telescopico per lavabo, 1"1/4, ottone cromato

40S020125 **caja / box / boîte / scatola**

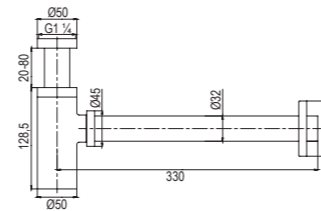

### MOD. B

**Sifón telescópico de lavabo 1"1/4, zamac cromado**  
Telescopic basin waste trap, 1"1/4, chromed zamak  
Siphon télescopique de lavabo, 1"1/4, zamak chromé  
Sifone telescopico per lavabo, 1"1/4, zamak cromato

400040125 **caja / box / boîte / scatola**

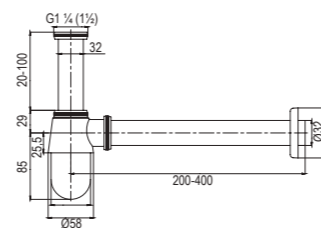

### FOSC

**Sifón telescópico de lavabo 1"1/4, zamac, negro**  
Telescopic basin waste trap, 1"1/4, zamak, black  
Siphon télescopique de lavabo, 1"1/4, zamak noir  
Sifone telescopico per lavabo, 1"1/4, zamak nero

400110525 **caja / box / boîte / scatola**

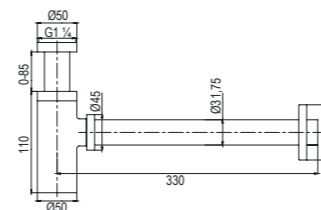

### CLAR

**Sifón telescópico de lavabo 1"1/4, zamac, blanco**  
Telescopic basin waste trap, 1"1/4, zamak, white  
Siphon télescopique de lavabo, 1"1/4, zamak blanc  
Sifone telescopico per lavabo, 1"1/4, zamak bianco

400110325 **caja / box / boîte / scatola**

NEW

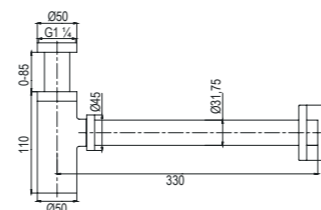

## VÁLVULAS CLIC-CLAC / CLICK WASTE VALVES BONDES CLIC-CLAC / VALVOLE DI SCARICO CLIC-CLAC



### LUCK

**Válvula clic-clac universal tapon plano, cromo, vida garantizada de 200.000 ciclos**  
Universal click waste valve with flat top, chrome, guaranteed lifetime of 200.000 cycles  
Bonde clic-clac universelle, chromée, bouchon plat, durée de vie garantie de 200.000 cycles  
Valvola di scarico clic-clac universale, cromata, tappo piatto, vita garantita di 200.000 cicli

400090140 **blister**

400090125 **caja / box / boîte / scatola**

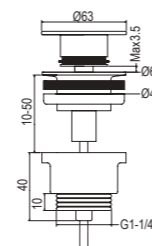

### UNIVERSAL

**Válvula clic-clac, cromo, vida garantizada de 200.000 ciclos**  
Click waste valve, chrome, guaranteed lifetime of 200.000 cycles  
Bonde clic-clac, chromée, durée de vie garantie de 200.000 cycles  
Valvole di scarico clic-clac, cromata, vita garantita di 200.000 cicli

400070140 **blister**

400070125 **caja / box / boîte / scatola**

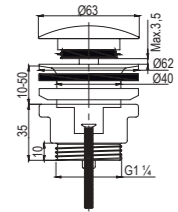

### UNIECO

**Válvula clic-clac, cromo, vida garantizada de 200.000 ciclos**  
Click waste valve, chrome, guaranteed lifetime of 200.000 cycles  
Bonde clic-clac, chromée, durée de vie garantie de 200.000 cycles  
Valvole di scarico clic-clac, cromata, vita garantita di 200.000 cicli

400080140 **blister**

400080125 **caja / box / boîte / scatola**

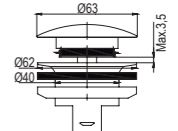

### ECO 6C

**Válvula clic-clac tuerca cilíndrica con rebosadero, vida garantizada de 200.000 ciclos**  
Click waste valve, cylindrical nut with overflow, guaranteed lifetime of 200.000 cycles  
Bonde clic-clac, écrou cylindrique avec trop-plein, durée de vie garantie de 200.000 cycles  
Valvole di scarico clic-clac, dado cilindrico con troppopieno, vita garantita di 200.000 cicli

40C010140 **blister**

40C010125 **caja / box / boîte / scatola**

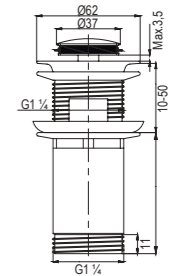

### ECO 7S

**Válvula clic-clac tuerca corredera con rebosadero, vida garantizada de 200.000 ciclos**  
Click waste valve, sliding nut with overflow, guaranteed lifetime of 200.000 cycles  
Bonde clic-clac, écrou coulissant avec trop-plein, durée de vie garantie de 200.000 cycles  
Valvole di scarico clic-clac, dado scorrevole con troppopieno, vita garantita di 200.000 cicli

400020140 **blister**

400020125 **caja / box / boîte / scatola**

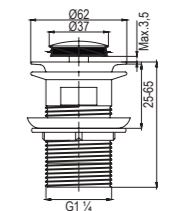

### NORM C

**Válvula clic-clac tuerca cilíndrica con rebosadero, vida garantizada de 200.000 ciclos**  
Click waste valve, cylindrical nut with overflow, guaranteed lifetime of 200.000 cycles  
Bonde clic-clac, écrou cylindrique avec trop-plein, durée de vie garantie de 200.000 cycles  
Valvole di scarico clic-clac, dado cilindrico con troppopieno, vita garantita di 200.000 cicli

400050140 **blister**

400050125 **caja / box / boîte / scatola**

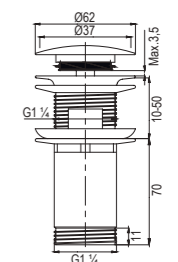



**ABS**

**Válvula clic-clac con rebosadero, vida garantizada de 200.000 ciclos, ABS cromada**  
Click waste valve with overflow, guaranteed lifetime of 200.000 cycles, chromed ABS  
Bonde clic-clac avec trop-plein, durée de vie garantie de 200.000 cycles, ABS chromée  
Valvole di scarico clic-clac con troppopieno, vita garantita di 200.000 cicli, ABS cromata

400070910 **bolsa / bag / sachet / bag**

**NEW**

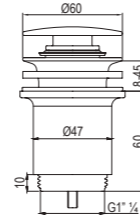

**LUCK**

**Válvula clic-clac universal con tapón plano negro mate, vida garantizada de 200.000 ciclos**  
Universal click waste valve with black matt flat top, guaranteed lifetime of 200.000 cycles  
Bonde clic-clac universelle, noire mate, bouchon plat, durée de vie garantie de 200.000 cycles  
Valvola di scarico clic-clac universale, nera opaca, tappo piatto, vita garantita di 200.000 cicli

400090540 **blister**

400090525 **caja / box / boîte / scatola**

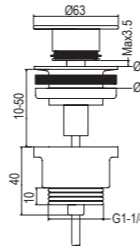

**UNIVERSAL**

**Válvula clic-clac, blanca, vida garantizada de 200.000 ciclos**  
Click waste valve, white, guaranteed lifetime of 200.000 cycles  
Bonde clic-clac, blanc, durée de vie garantie de 200.000 cycles  
Valvole di scarico clic-clac, bianca, vita garantita di 200.000 cicli

400070325 **caja / box / boîte / scatola**

**NEW**

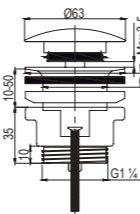

**LLAVES DE ESCUADRA / ANGLE VALVES**  
PRISES D'EAU / PRESE D'ACQUA

**LLAVE DOBLE**

**Llave de escuadra doble 1/2"-1/2" con monturas cerámicas**  
1/2"-1/2" double angled valve with ceramic headparts  
Double prise d'eau 1/2"-1/2" avec montures céramiques  
Doppia presa d'acqua 1/2"-1/2" con vitone ceramico

40LLC006



**SCUT**

**Llave de escuadra 1/2"-3/8" con montura cerámica y filtro inoxidable, en rojo y azul**  
Angle valve 1/2"-3/8" with ceramic headpart and stainless steel filter, in red and blue  
Prise d'eau 1/2"-3/8" avec monture céramique et filtre inox, en bleu et rouge  
Presa d'acqua 1/2"-3/8" con vitone ceramico e filtro inossidabile, in blu e rosso

**Azul / Blue / Bleu / Blu**

40LLC004

**Rojo / Red / Rouge / Rosso**

40LLC005



**DROP**

**Llave de escuadra 1/2"-3/8" con montura cerámica y filtro inoxidable, en azul**  
Angle valve 1/2"-3/8" with ceramic headpart and stainless steel filter, in blue  
Prise d'eau 1/2"-3/8" avec monture céramique et filtre inox, en bleu  
Presa d'acqua 1/2"-3/8" con vitone ceramico e filtro inossidabile, in blu

40LLC002



**ECO PUSH**

**Aireador con pulsador de apertura y cierre con limitador de caudal 6,25 l/min. Compatible con macho M24**  
Aerator with push button for opening and closing with flow rate restrictor 6,25 l/min. Suitable with male M24  
Aérateur avec bouton-poussoir d'ouverture et de fermeture avec limiteur de débit 6,25 l/min. Compatible avec mâle M24  
Aeratore con apertura a pulsante e chiusura con limitatore di portata 6,2 l/min. Compatibile con maschio M24

40AIR0050130 **6,25 l/min 3 bar**



**2 JETS ECO**

**Aireador de dos funciones con limitador de caudal 7 l/min. Compatible con macho M24 y hembra M22**  
Two functions aerator with flow rate restrictor 7 l/min. Suitable with male M24 and female M22  
Aérateur de deux fonctions avec limiteur de débit 7 l/min. Compatible avec mâle M24 et femelle M22  
Aeratore a due funzioni con limitatore di portata 7 l/min. Compatibile con maschio M24 e femmina M22

40AIR0030130 **7 l/min 3 bar**



**2 JETS-R ECO**

**Aireador de dos funciones con rótula y limitador de caudal 7 l/min. Compatible con macho M24 y hembra M22**  
2 functions aerator with swivel and with flow rate restrictor 7 l/min. Suitable with male M24 and female M22  
Aérateur de deux fonctions avec rotule et limiteur de débit 7 l/min. Compatible avec mâle M24 et femelle M22  
Aeratore a due funzioni con snodo sferico e limitatore di portata 7 l/min. Compatibile con maschio M24 e femmina M22

40AIR0040130 **7 l/min 3 bar**



**ECO FLEX**

**Aireador con flexo y limitador de caudal 7 l/min. Compatible con macho M24 y hembra M22**  
Aerator with flexible hose with flow rate restrictor 7 l/min. Suitable with male M24 and female M22  
Aérateur avec flexible et limiteur de débit 7 l/min. Compatible avec mâle M24 et femelle M22  
Aeratore con flessibile e limitatore di portata 7 l/min. Compatibile con maschio M24 e femmina M22

40AIR0010130 **7 l/min 3 bar**





**ACCESORIOS**  
**ACCESSORIES**  
**ACCESSOIRES**  
**ACCESSORI**



Jabonera / Shower basket / Étagère de douche / Mensola per doccia  
T20



Jabonera / Shower basket / Étagère de douche / Mensola per doccia  
R21



Jabonera / Shower basket / Étagère de douche / Mensola per doccia  
S01



**S01**

**Rectangular, adaptable a barras de diámetros desde 22 mm hasta 25 mm, cromada**  
Rectangular, suitable for bars from 22 to 25 mm diameter, chromed  
Rectangulaire, adaptable aux barres de diamètre de 22 jusqu'à 25 mm, chromé  
Rettangolare, adattabile a barre di diametro da 22 a 25 mm, cromate

30003S010120

x16

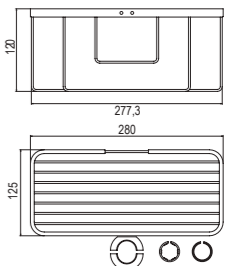

**T20**

**Triangular, acabado pulido espejo**  
Triangle, mirror polish  
Triangulaire d'angle, finition poli miroir  
Triangolare, finitura lucida a specchio

30001T200120

x20

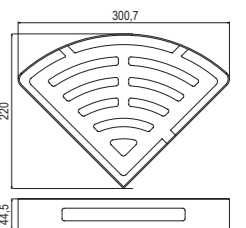

**R21**

**Rectangular, acabado pulido espejo**  
Rectangular, mirror polish  
Rectangulaire, finition poli miroir  
Rettangolare, finitura lucida a specchio

30001R210120

x20

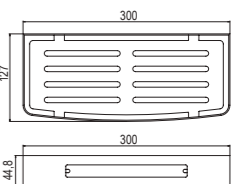



**O05**

**Ovalada, cromada**  
Oval, chromed  
Ovale, chromé  
Ovale cromata

30001O050120

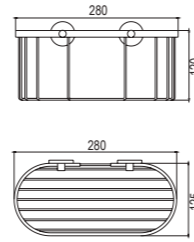

**R03**

**Rectangular de 40 cm, cromada**  
Rectangular 40 cm, chromed  
Rectangulaire de 40 cm, chromé  
Rettangolare 40 cm, cromata

30001R030120

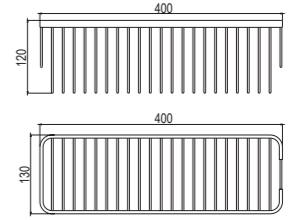

**R02**

**Rectangular de 30 cm, cromada**  
Rectangular 30 cm, chromed  
Rectangulaire de 30 cm, chromé  
Rettangolare 30 cm, cromata

30001R020120

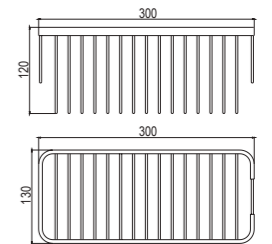

**T01**

**Triangular, cromada**  
Triangle, chromed  
Triangulaire d'angle, chromé  
Triangolare, chromed

30001T010120

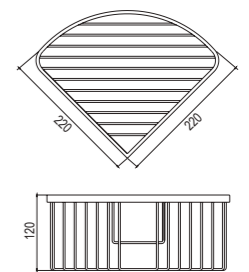

**E06**

**Esquinera, cromada**  
Corner, chromed  
Angle, chromé  
Angolo, cromata

30001E060120

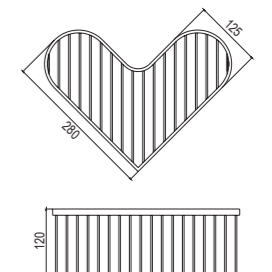



**T11**

Triangular de dos niveles, cromada  
Triangle two-level, chromed  
Triangulaire d'angle double, chromé  
Doppio angolo triangolare, cromata

30001T110120

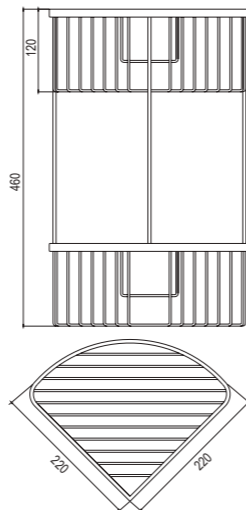

**C07**

Rectangular, cromada para colgar en grifo  
Rectangle, chromed to hang on the faucet  
Rectangulaire, chromé, pour accrocher sur le robinet  
Rettangolare, cromata da appendere al rubinetto

30002C070120

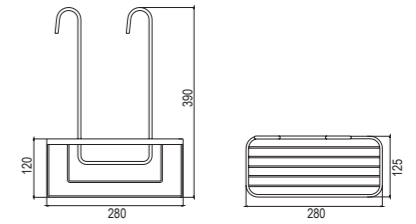

**C08**

Ovalada, cromada para colgar en grifo  
Oval, chromed to hang on the faucet  
Ovale, chromé, pour accrocher sur le robinet  
Ovale, cromata da appendere al rubinetto

30002C080120

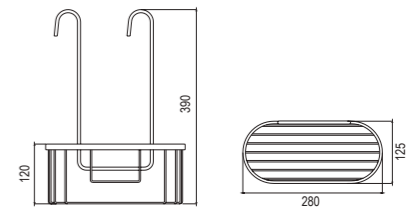

Jabonera / Shower basket / Étagère de douche / Mensola per doccia  
C07



Jabonera / Shower basket / Étagère de douche / Mensola per doccia  
C08



**T01**

**Triangular, negro**  
Triangle, black  
Triangulaire d'angle, noir  
Triangolare, nero

30001T010520

NEW

x16

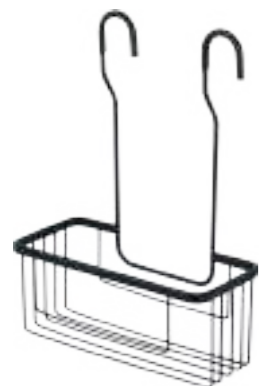
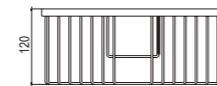
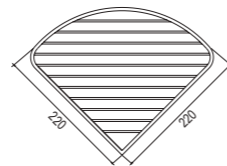

**C07**

**Rectangular, negro, para colgar en grifo**  
Rectangle, black, to hang on the faucet  
Rectangulaire, noir, pour accrocher sur le robinet  
Rettangolare, nero, da appendere al rubinetto

30002C070520

NEW

x8

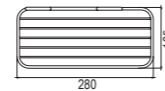
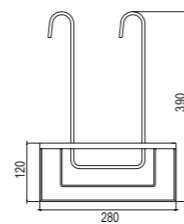

### 201

**Asidero Ø 25 mm moleteado en acero inoxidable AISI 304 cromado con fijación reforzada**  
Chromed knurled grab bar in chromed stainless steel AISI 304 with reinforced fixing system Ø 25 mm  
Poignée ø 25 mm moletée en acier inoxydable AISI 304 chromé avec fixation renforcée  
Maniglione zigrinato Ø 25 mm in acciaio inossidabile AISI 304 cromato con fissaggio rinforzato



**25 cm**

caja / box  
boîte / scatola **33ASI0250125**

**30 cm**

caja / box  
boîte / scatola **33ASI0300125**

**40 cm**

caja / box  
boîte / scatola **33ASI0400125**

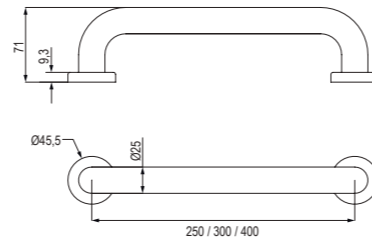

### FIJACIÓN REFORZADA / REINFORCED FIXING FIXATION RENFORCÉE / FISSAGGIO RINFORZATO

Todos nuestros asideros disponen de un sistema de sujeción reforzado y de embellecedores con rosca. Dos platinas de 2,7 mm de grosor garantizan una fuerte sujeción a la pared y un apoyo seguro. Los embellecedores a rosca aseguran que estos queden siempre fijos en su sitio.

All our grab bars have a reinforced fixing system and flanges with thread. Two platen plates of 2.7 mm thickness guarantee a strong fixing to the wall as well as a reliable support. The flanges with thread guarantee that these are always fixed in place.

Toutes nos poignées ont un système de fixation renforcée et enjoliveurs avec filetage. Deux platines de 2,7 mm d'épaisseur garantissent une forte prise sur le mur et un appui solide. Les enjoliveurs filetés assurent leur fixation constamment sur place.

Tutti i nostri maniglioni hanno un sistema di fissaggio rinforzato e coprimozzi con filettatura. Due lastre da 2,7 mm di spessore garantiscono una forte presa sulla parete e un solido supporto. I coprimozzi filettati assicurano il loro fissaggio costante sul posto.



### HQ

**Asidero Ø 25 mm moleteado en acero inoxidable AISI 304 cromado con fijación reforzada**  
Chromed knurled grab bar in chromed stainless steel AISI 304 with reinforced fixing system Ø 25 mm  
Poignée ø 25 mm moletée en acier inoxydable AISI 304 chromé avec fixation renforcée  
Maniglione zigrinato Ø 25 mm in acciaio inossidabile AISI 304 cromato con fissaggio rinforzato



**25 cm**

caja / box  
boîte / scatola **33HQ0250120**

blister / blister  
blister / blister **33HQ0250130**

**30 cm**

caja / box  
boîte / scatola **33HQ0300120**

blister / blister  
blister / blister **33HQ0300130**

**40 cm**

caja / box  
boîte / scatola **33HQ0400120**

blister / blister  
blister / blister **33HQ0400130**

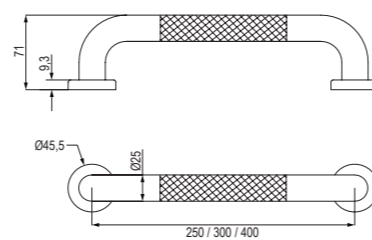

### ELE

**Asidero Ø 25 mm moleteado de 45 cm acero inoxidable AISI 304 cromado con fijación reforzada**  
Knurled grab bar of 45 cm in chromed stainless steel AISI 304 with reinforced fixing system Ø 25 mm  
Poignée ø 25 mm moletée de 45 cm en acier inoxydable AISI 304 chromé avec fixation renforcée  
Maniglione zigrinato Ø 25 mm de 45 cm in acciaio inossidabile AISI 304 cromato con fissaggio rinforzato



caja / box  
boîte / scatola **33ELE0450120**

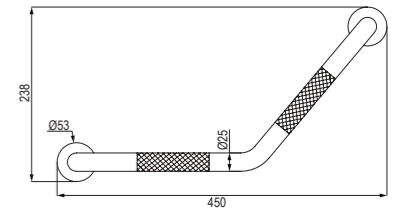

### ZETA

**Asidero Ø 25 mm moleteado de 50 cm acero inoxidable AISI 304 cromado con fijación reforzada**  
Knurled grab bar of 50 cm in chromed stainless steel AISI 304 with reinforced fixing system Ø 25 mm  
Poignée ø 25 mm moletée de 50 cm en acier inoxydable AISI 304 chromé avec fixation renforcée  
Maniglione zigrinato Ø 25 mm de 50 cm in acciaio inossidabile AISI 304 cromato con fissaggio rinforzato



caja / box  
boîte / scatola **33ZETA0500120**

blister / blister  
blister / blister **33ZETA0500130**

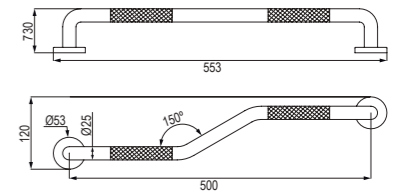

### BD

**Barra ø 32 mm moleteada de 60 cm acero inoxidable AISI 304 pulido espejo con fijación reforzada**  
Knurled grab bar of 60 cm in mirror-polished stainless steel AISI 304 with reinforced fixing system ø 32 mm  
Barre ø 32 mm moletée de 60 cm en acier inoxydable AISI 304 poli miroir avec fixation renforcée  
Barra zigrinata Ø 32 mm de 60 cm in acciaio inossidabile AISI 304 lucida a specchio con fissaggio rinforzato



caja / box  
boîte / scatola **33BD0600120**

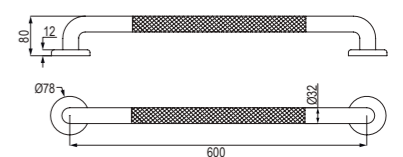

### ABATIBLE

**Barra abatible de 80 cm acero inox AISI 304 mate ø 32 mm**  
Folding grab bar of 80 cm in matte stainless steel AISI 304 ø 32 mm  
Barre abattable de 80 cm en acier inoxydable AISI 304 mat Ø 32 mm  
Barra reclinabile de 80 cm in acciaio inossidabile AISI 304 opaco Ø 32 mm

caja / box  
boîte / scatola **33ABA0800120**

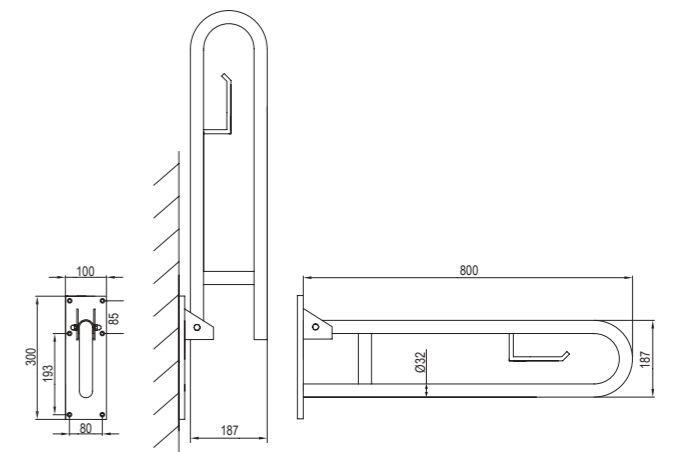
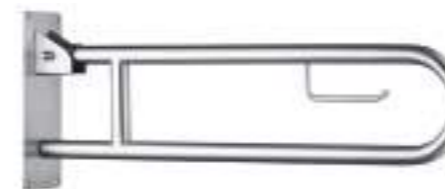



PORTATOALLAS / WALL-MOUNTED TOWEL RACK / PORTE-SERVIETTES MURAL / PORTASCIUGAMANI DA PARETE



**EMMA**

Portatoallas de pared de acero inoxidable de alta calidad AISI 304, acabado pulido espejo  
Wall-mounted towel rack in stainless steel high quality AISI 304 mirror polish  
Porte-serviettes mural en acier inoxydable de haute qualité AISI 304, poli miroir  
Portasciugamani a parete in acciaio inossidabile di alta qualità AISI 304 finitura lucida a specchio

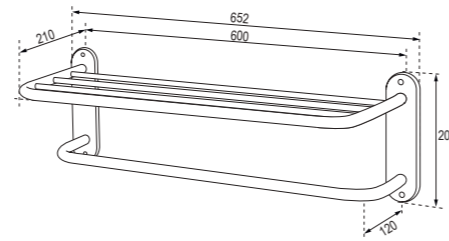

31EMM00601



**HOK**

Toallero lateral para mueble de acero inoxidable AISI 304 cromado  
Lateral towel bar for furniture in chromed stainless steel AISI 304  
Porte-serviette latéral pour meuble en acier inoxydable AISI 304  
Portasciugamani laterale per mobili in acciaio inossidabile AISI 304



Cromo / Chrome / Chromé / Cromato

29 cm	31T291301
36 cm	31T361301



Negro / Black / Noir / Nero

36 cm	31T361305
-------	-----------

NEW

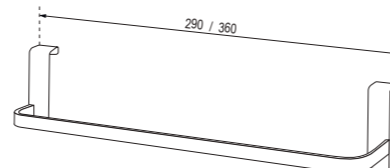

**SUNE**



Toallero barra 45 cm de acero inoxidable AISI 304 y zamak, cromo

Towel bar 45 cm, AISI 304 stainless steel and zamak, chrome  
Barre à serviette 45 cm en acier inoxydable AISI 304 et zamak, chrome  
Portasciugamani 45 cm, in acciaio inossidabile AISI 304 e zamak, cromato

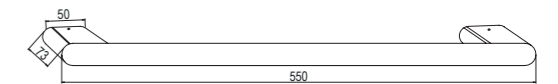

31SUN00101

Toallero abierto de acero inoxidable AISI 304 y zamak, cromo

Towel holder, AISI 304 stainless steel and zamak, chrome  
Support à serviette en acier inoxydable AISI 304 et zamak, chrome  
Portasciugamani aperto in acciaio inossidabile AISI 304 e zamak, cromato

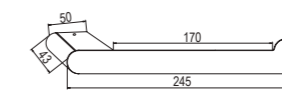

31SUN00301



Portarrollos de acero inoxidable AISI 304 y zamak, cromo

Paper holder, AISI 304 stainless steel and zamak, chrome  
Support à papier en acier inoxydable AISI 304 et zamak, chrome  
Portarrotoli in acciaio inossidabile AISI 304 e zamak, cromato

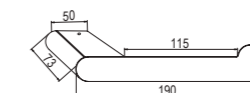

31SUN00701

Percha de acero inoxidable AISI 304 y zamak, cromo

Single hook, AISI 304 stainless steel and zamak, chrome  
Crochet en acier inoxydable AISI 304 et zamak, chrome  
Gancio in acciaio inossidabile AISI 304 e zamak, cromato

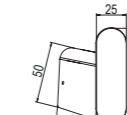

31SUN01001





# HERA

ACCESORIOS DE FIJAR / FIXING ACCESSORIES  
ACCESSOIRES À FIXER / ACCESSORI DI FISSAGGIO



**Toallero barra 45 cm de acero inoxidable AISI 304 y zamak, cromo**  
Towel bar 45 cm, AISI 304 stainless steel and zamak, chrome  
Barre à serviette 45 cm en acier inoxydable AISI 304 et zamak, chrome  
Portasciugamani 45 cm in acciaio inossidabile AISI 304 e zamak, cromato

31HER00101

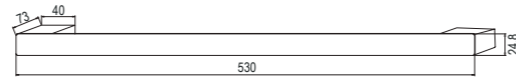

**Toallero abierto de acero inoxidable AISI 304 y zamak, cromo**  
Towel holder, AISI 304 stainless steel and zamak, chrome  
Support à serviette en acier inoxydable AISI 304 et zamak, chrome  
Portasciugamani aperto in acciaio inossidabile AISI 304 e zamak, cromato

31HER00301

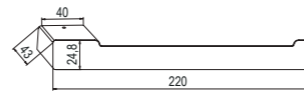

**Portarrollos de acero inoxidable AISI 304 y zamak, cromo**  
Paper holder, AISI 304 stainless steel and zamak, chrome  
Support à papier en acier inoxydable AISI 304 et zamak, chrome  
Portarotoli in acciaio inossidabile AISI 304 e zamak, cromato

31HER00701

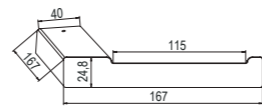

**Percha doble de acero inoxidable AISI 304 y zamak, cromo**  
Double hook, AISI 304 stainless steel and zamak, chrome  
Double crochet en acier inoxydable AISI 304 et zamak, chrome  
Doppio gancio in acciaio inossidabile AISI 304 e zamak, cromato

31HER01101

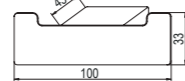

**Percha de acero inoxidable AISI 304 y zamak, cromo**  
Single hook, AISI 304 stainless steel and zamak, chrome  
Crochet en acier inoxydable AISI 304 et zamak, chrome  
Gancio in acciaio inossidabile AISI 304 e zamak, cromato

31HER01001

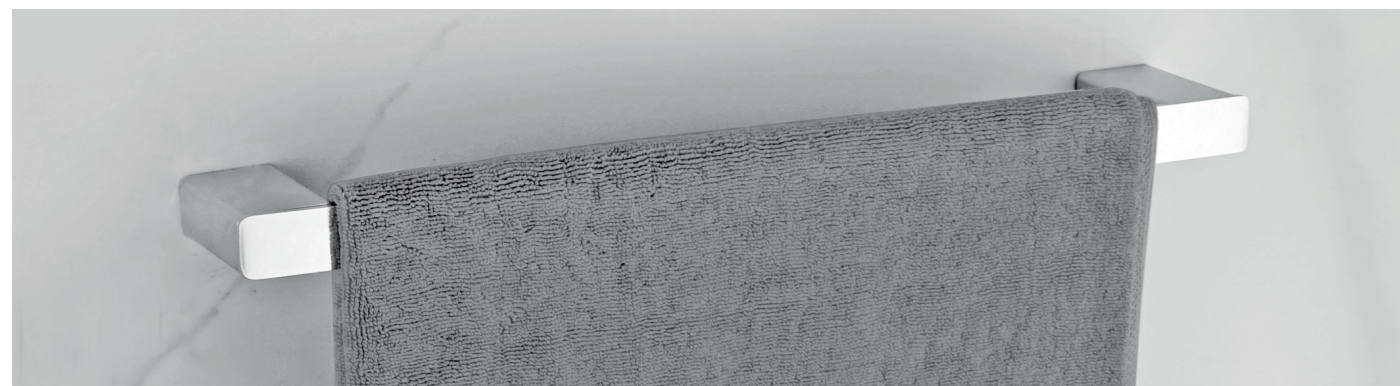
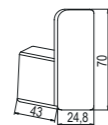

# CALE

ACCESORIOS DE FIJAR / FIXING ACCESSORIES  
ACCESSOIRES À FIXER / ACCESSORI DI FISSAGGIO



**Toallero barra 45 cm de latón y zamak, cromo**  
Towel bar 45 cm, brass and zamak, chrome  
Barre à serviette 45 cm en laiton et zamak, chrome  
Portasciugamani 45 cm, in ottone e zamak, cromato

31CAL00101

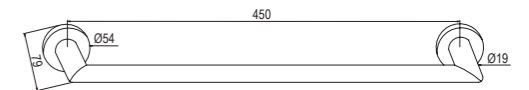

**Toallero abierto de latón y zamak, cromo**  
Towel holder, brass and zamak, chrome  
Support à serviette en laiton et zamak, chrome  
Portasciugamani aperto, in ottone e zamak, cromato

31CAL00301

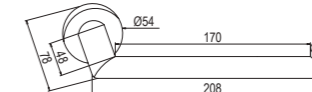

**Portarrollos de latón y zamak, cromo**  
Paper holder, brass and zamak, chrome  
Support à papier en laiton et zamak, chrome  
Portarotoli, in ottone e zamak, cromato

31CAL00701

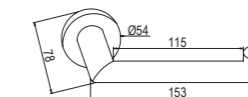

**Percha de latón y zamak, cromo**  
Single hook, brass and zamak, chrome  
Crochet en laiton et zamak, chrome  
Gancio, in ottone e zamak, cromato

31CAL01001

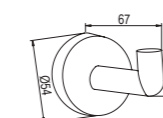



**Toallero barra 40 cm de latón y zamak, cromo**  
Towel bar 40 cm, brass and zamak, chrome  
Barre à serviette 40 cm en laiton et zamak, chrome  
Portasciugamani 40 cm, in ottone e zamak, cromato

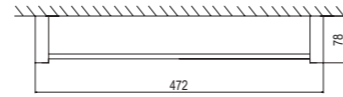

31KUN00101



**Toallero doble 45 cm de latón y zamak, cromo**  
Double towel bar 45 cm, brass and zamak, chrome  
Barre double à serviette 45 cm en laiton et zamak, chrome  
Portasciugamani doppio 45 cm, in ottone e zamak, cromato

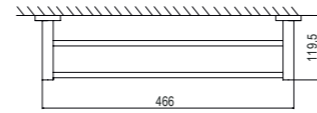

31KUN00201

**Percha doble de zamak, cromo**  
Double hook, zamak, chrome  
Crochet double en zamak, chrome  
Doppio gancio in zamak, cromato

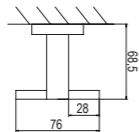

31KUN01101

**Percha de zamak, cromo**  
Single hook, zamak, chrome  
Crochet en zamak, chrome  
Gancio in zamak, cromato

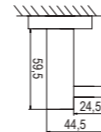

31KUN01001

**Toallero abierto de zamak, cromo**  
Open towel ring, zamak, chrome  
Support à serviette en zamak, chrome  
Portasciugamani aperto in zamak, cromato

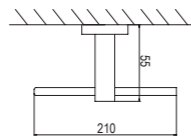

31KUN00301

**Portarrollos de zamak, cromo**  
Paper holder, zamak, chrome  
Support à papier en zamak, chrome  
Portarrotoli in zamak, cromato

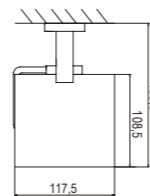

31KUN00701



**Portatoallas de latón, cromo**  
Towel holder, brass, chrome  
Porte-serviettes en laiton, chrome  
Portasciugamani in ottone, cromato

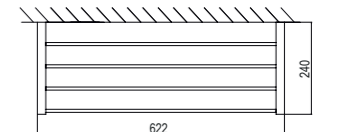

31DYN00701

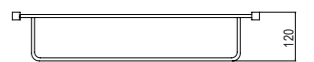

**Toallero barra 45 cm, en acero inoxidable AISI 304 y zamak, cromo**  
Towel bar 45 cm, AISI 304 stainless steel and zamak, chrome  
Barre à serviette 45 cm, en acier inoxydable AISI 304 et zamak, chrome  
Portasciugamani 45 cm in acciaio inossidabile AISI 304 e zamak, cromato

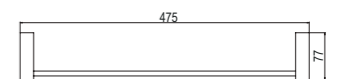

31DYN00101

**Toallero aro de zamak, cromo**  
Towel ring, zamak, chrome  
Anneau à serviette en zamak, chrome  
Anello asciugamani in zamak, cromato



31DYN00501

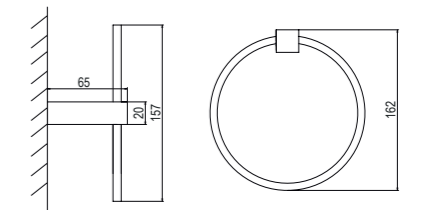

**Toallero abierto reversible de latón y zamak, cromo**  
Reversible towel ring, brass and zamak, chrome  
Support à serviette réversible en laiton et zamak, chrome  
Portasciugamani aperto reversibile in ottone e zamak, cromato



31DYN00401

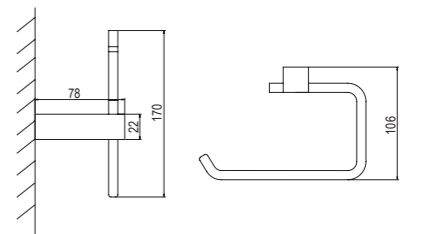



**Portarrollos reversible, de zamak, cromo**  
Reversible paper holder, zamak, chrome  
Support à papier réversible, en zamak, chrome  
Portarrotoli reversibile, in zamak, cromato

31DYN00901

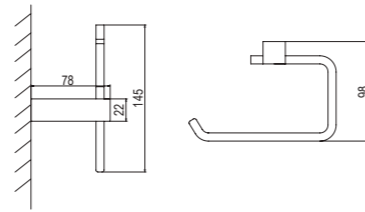

**Portarrollos con tapa, de acero inoxidable AISI 304 y zamak, cromo**  
Paper holder with cover, AISI 304 stainless steel and zamak, chrome  
Support à papier avec couvercle, en acier inoxydable AISI 304 et zamak, chrome  
Portarrotoli con coperchio, in acciaio inossidabile AISI 304 e zamak, cromato

31DYN00601

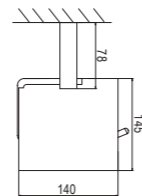

**Percha, de zamak, cromo**  
Single hook, zamak, chrome  
Crochet, en zamak, chrome  
Gancio, in zamak, cromato

31DYN01001

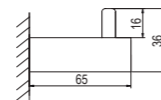

**Escobillero de pared de zamak, cromo**  
Wall-mounted toilet brush holder, zamak, chrome  
Porte-balai du mur en zamak, chrome  
Portaspazzole a muro in zamak, cromato

31DYN01201

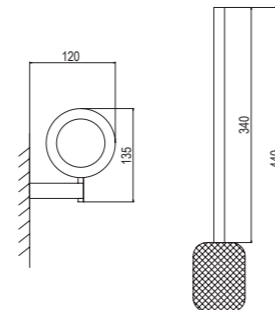

**Taburete para el baño**  
Bath stool  
Tabouret de bain  
Sgabello da bagno

33TAB03

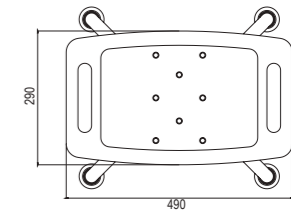
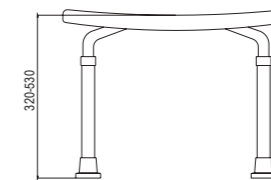

**CARACTERÍSTICAS**

- Patas regulables en altura, extensibles de 32 a 53 cm
- Asiento con superficie rugosa antideslizante y con agujeros de drenaje que aseguran un mayor efecto antideslizante
- Patas de aluminio acabado brillante con alta resistencia a la corrosión y con topes de goma para una mejor fijación
- Asiento ultraligero con asas incorporadas que facilitan su movilidad
- Soporta de forma segura hasta 100 kg

**CHARACTERISTICS**

- Legs adjustable in height, extensible from 32 to 53 cm
- Seat with rough non-slip surface and with multiple drainage holes to ensure a better grip
- Frame in aluminum bright finish with high resistance to corrosion and with suction tips to secure in place
- Ultralight seat with integrated handles, easy to carry around
- Securely holds up to 100 kg

**CHARACTÉRISTIQUES**

- Pieds réglables en hauteur, extensibles de 32 à 53 cm.
- Siège avec surface rugueuse antidérapante et avec trous de drainage qui assurent un meilleur effet antidérapant
- Pieds en aluminium fini brillant avec une haute résistance à la corrosion et avec embouts en caoutchouc pour une meilleure fixation
- Siège ultraléger avec poignées intégrées facile à déplacer
- Supporte en toute sécurité jusqu'à 100 kg

**CARATTERISTICHE**

- Piedi regolabili in altezza, estensibili da 32 a 53 cm.
- Sedile con superficie ruvida antiscivolo e fori di drenaggio per un migliore effetto antiscivolo
- Piedini in alluminio con finitura brillante, elevata resistenza alla corrosione e puntali in gomma per una migliore fissazione
- Sedile ultraleggero con maniglie integrate facili da trasportare ovunque
- Supporta in sicurezza fino a 100 kg

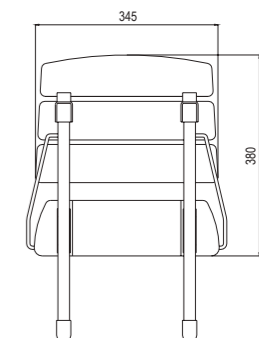
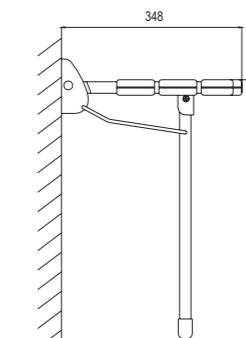

**CARACTERÍSTICAS**

- Soporta 160 Kg. de forma segura
- Patas ajustables en altura de acero con recubrimiento de pintura Epoxi y con topes de goma para una mejor fijación
- Plataforma de sujeción a la pared de aluminio
- Asiento de ABS

**CHARACTERISTICS**

- Supports up to 160 kg safely
- Steel legs adjustable in height with Epoxi paint coating and suction tips to secure in place
- Aluminium platform fixed to wall
- ABS seat

**CHARACTÉRISTIQUES**

- Support 160 kg en toute sécurité
- Pieds réglables en hauteur en acier avec recouvrement de peinture Epoxi et avec embouts en caoutchouc pour une meilleure fixation
- Plate-forme d'aluminium fixée au mur
- Siège en ABS

**CARATTERISTICHE**

- Supporta da 160 kg in totale sicurezza
- Gambe regolabili in altezza in acciaio con rivestimento in vernice Epoxi e puntali in gomma per una migliore fissazione
- Pedana in alluminio fissata al muro
- Sedile in ABS

33APL03





**RECAMBIOS**  
**SPARE PARTS**  
**PIÈCES DE RECHANGE**  
**PEZZI DI RICAMBIO**

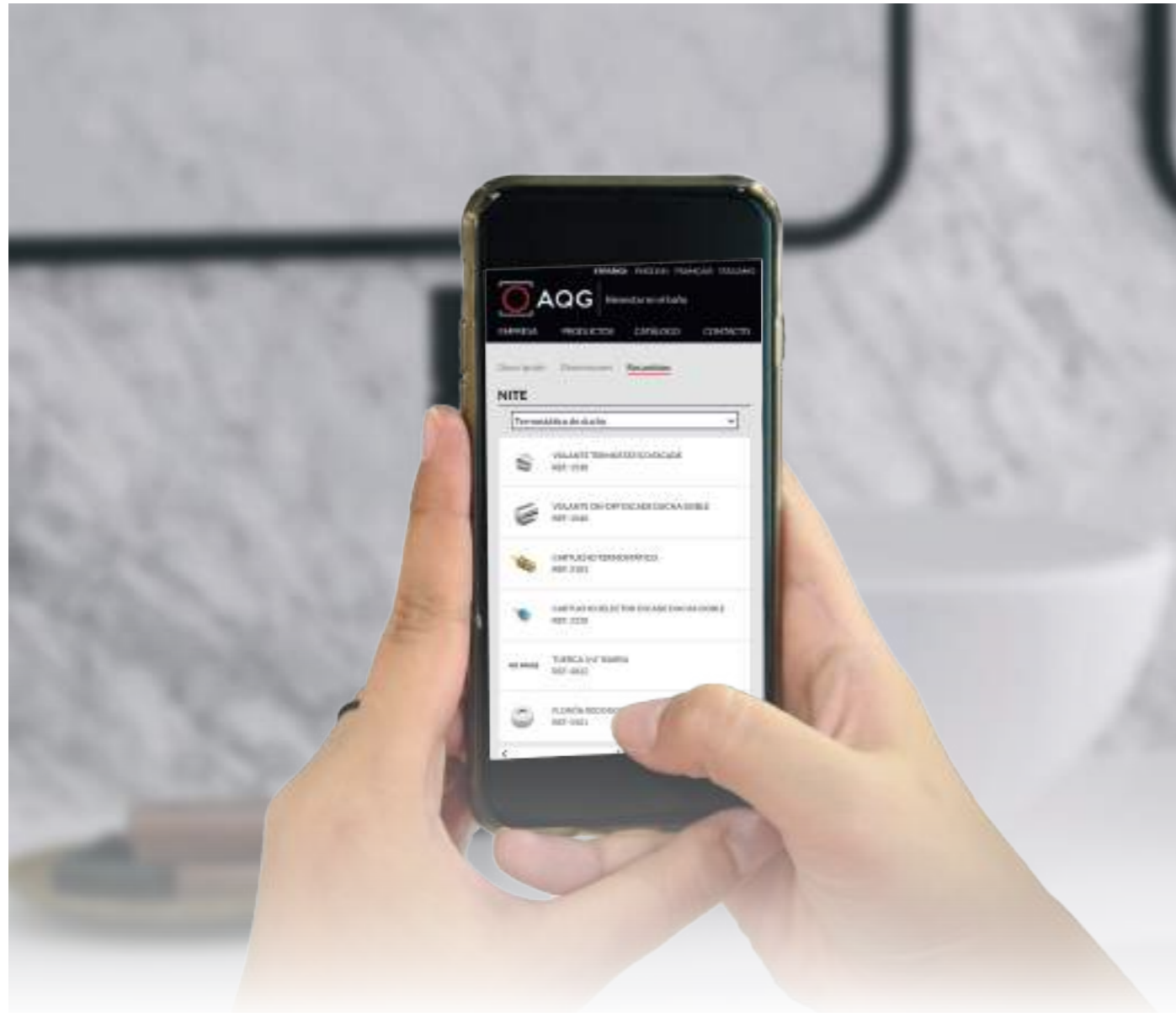

ENCUENTRE EN NUESTRA PÁGINA WEB **EL RECAMBIO** QUE NECESITA

PLEASE FIND **THE SPARE PARTS** YOU NEED IN OUR WEBSITE

VOUS TROUVEREZ SUR NOTRE SITE WEB **LA PIÈCE DE RECHANGE** DONT VOUS AVEZ BESOIN

TROVA **IL PEZZO DI RICAMBIO** DI CUI HAI BISOGNO SUL NOSTRO SITO WEB

[www.aquagrif.com](http://www.aquagrif.com)

Vea cómo hacerlo en nuestro vídeo demostrativo

Check how to do it in our demo video

Voyez comment effectuer la recherche grâce à notre video explicative

Guarda come farlo nel nostro video dimostrativo



	<b>MONTURA CERÁMICA 90°</b> CERAMIC HEADPART 90° TÊTE CÉRAMIQUE 90° VITONE CERAMICO 90°		<b>VOLANTE SELECTOR TERM. ONNA-RIO</b> THERM. HANDLE SELECTOR ONNA-RIO POIGNÉE SÉLECTEUR THERMO. ONNA-RIO MANICO SELETTORE TERMO. ONNA-RIO
	1000		1502
	<b>MONTURA CERÁMICA 90°</b> CERAMIC HEADPART 90° TÊTE CÉRAMIQUE 90° VITONE CERAMICO 90°		<b>VOLANTE SELECTOR MM-TERM. EDNA</b> THERM. HANDLE SELECTOR MM-TERM. EDNA POIGNÉE SÉLECTEUR THERMO. & MITIGEUR EDNA MANICO SELETTORE TERMO. & MISCELATORE EDNA
	1002		1503
	<b>MONTURA CERÁMICA 180°</b> CERAMIC HEADPART 180° TÊTE CÉRAMIQUE 180° VITONE CERAMICO 180°		<b>VOLANTE ON-OFF OLYMPIC NEGRO</b> OLYMPIC ON-OFF HANDLE BLACK POIGNÉE ON-OFF OLYMPIC NOIRE MANICO ON-OFF OLYMPIC NERO
	1003		1505NG
	<b>MONTURA CERÁMICA 90° SUMMER</b> CERAMIC HEADPART 90° SUMMER TÊTE CÉRAMIQUE 90° SUMMER VITONE CERAMICO 90° SUMMER		<b>VOLANTE ON-OFF OLYMPIC BLANCO</b> OLYMPIC ON-OFF HANDLE WHITE POIGNÉE ON-OFF OLYMPIC BLANC MANICO ON-OFF OLYMPIC BIANCO
	1004		1505BL
	<b>MONTURA CERÁMICA 90° SUMMER CAÑO</b> CERAMIC HEADPART 90° SUMMER SPOUT TÊTE CÉRAMIQUE 90° SUMMER BEC VITONE CERAMICO 90° SUMMER COLLO		<b>VOLANTE TERM. QUARK BAÑO</b> THERM. HANDLE QUARK BATH POIGNÉE THERMO. QUARK BAIN MANICO TERMO. QUARK VASCA
	1005		1506
	<b>MONTURA CERÁMICA 90° INOX</b> CERAMIC HEADPART 90° S.S. TÊTE CÉRAMIQUE 90° INOX VITONE CERAMICO 90° INOX		<b>VOLANTE ON-OFF QUARK BAÑO</b> ON-OFF HANDLE QUARK BATH POIGNÉE ON-OFF QUARK BAIN MANICO ON-OFF QUARK VASCA
	1007		1507
	<b>VÁLVULA PEDAL</b> FOOT VALVE VANNE ROBINET À PEDALE VALVOLA RUBINETTO A PEDALE		<b>VOLANTE TERM. SIGMA</b> THERM. HANDLE SIGMA POIGNÉE THERMO. SIGMA MANICO TERMO. SIGMA
	1009		1508
	<b>VÁLVULA PEDAL MEZCLADOR</b> MIXER FOOT VALVE VANNE MÉLANGEUR À PÉDALE VALVOLA MISCELATRICE A PEDALE		<b>VOLANTE ON-OFF SIGMA DUCHA</b> ON-OFF HANDLE SHOWER SIGMA POIGNÉE ON-OFF SIGMA DOUCHE MANICO ON-OFF DOCCIA SIGMA
	1010		1509
	<b>MONTURA CERÁMICA 90° ESCADE</b> CERAMIC HEADPART 90° ESCADE TÊTE CÉRAMIQUE 90° ESCADE VITONE CERAMICO 90° ESCADE		<b>VOLANTE ON-OFF SIGMA</b> ON-OFF HANDLE SIGMA POIGNÉE ON-OFF SIGMA MANICO ON-OFF SIGMA
	1013		1510
	<b>VOLANTE TERM. ONNA-RIO</b> THERM. HANDLE ONNA-RIO POIGNÉE THERMO. ONNA-RIO MANICO TERMO. ONNA-RIO		<b>VOLANTE TERM. LUXOR</b> THERM. HANDLE LUXOR POIGNÉE THERMO. LUXOR MANICO TERMO. LUXOR
	1500		1511
	<b>VOLANTE TERM. EDNA</b> THERM. HANDLE EDNA POIGNÉE THERMO. EDNA MANICO TERMO. EDNA		<b>VOLANTE TERM. QUS</b> THERM. HANDLE QUS POIGNÉE THERMO. QUS MANICO TERMO. QUS
	1501		1511NG



**VOLANTE ON-OFF LUXOR**  
ON-OFF HANDLE LUXOR  
POIGNÉE ON-OFF LUXOR  
MANICO ON-OFF LUXOR

---

**1512**

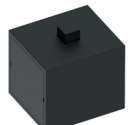

**VOLANTE ON-OFF QUS**  
ON-OFF HANDLE QUS  
POIGNÉE ON-OFF QUS  
MANICO ON-OFF QUS

---

**1512NG**



**VOLANTE TERM. ARTIC**  
THERM. HANDLE ARTIC  
POIGNÉE THERMO. ARTIC  
MANICO TERMO. ARTIC

---

**1513**



**VOLANTE ON-OFF ARTIC**  
ON-OFF HANDLE ARTIC  
POIGNÉE ON-OFF ARTIC  
MANICO ON-OFF ARTIC

---

**1514**



**VOLANTE SELECTOR ARTIC DUCHA MM**  
ARTIC SINGLE LEVER SHOWER SELECTOR  
HANDLE  
POIGNÉE SÉLECTEUR ARTIC MITIGEUR DOUCHE  
MANICO SELETTORE ARTIC MISCELATORE DOCCIA

---

**1515**



**VOLANTE SELECTOR ARTIC BAÑO MM**  
ARTIC SINGLE LEVER BATH SELECTOR HANDLE  
POIGNÉE SÉLECTEUR ARTIC MITIGEUR BAIN  
MANICO SELETTORE ARTIC MISCELATORE VASCA

---

**1516**



**VOLANTE SELECTOR SUMMER**  
SUMMER HANDLE SELECTOR  
POIGNÉE SÉLECTEUR SUMMER  
MANICO SELETTORE SUMMER

---

**1517**



**VOLANTE EMPOTRAR MM**  
CONCEALED SINGLE LEVER HANDLE  
POIGNÉE MITIGEUR À ENCASTRER  
MANICO MISCELATORE DA INCASSO

---

**1519**



**VOLANTE EMPOTRAR MM NEGRO**  
CONCEALED SINGLE LEVER HANDLE BLACK  
POIGNÉE MITIGEUR À ENCASTRER NOIRE  
MANICO MISCELATORE DA INCASSO NERO

---

**1519NG**



**VOLANTE EMPOTRAR MM BLANCO**  
CONCEALED SINGLE LEVER HANDLE WHITE  
POIGNÉE MITIGEUR À ENCASTRER BLANC  
MANICO MISCELATORE DA INCASSO BIANCO

---

**1519BL**



**VOLANTE EMPOTRAR MM**  
CONCEALED SINGLE LEVER HANDLE  
POIGNÉE MITIGEUR À ENCASTRER  
MANICO MISCELATORE DA INCASSO

---

**1520**



**VOLANTE EMPOTRAR MM NEGRO**  
CONCEALED SINGLE LEVER HANDLE BLACK  
POIGNÉE MITIGEUR À ENCASTRER NOIRE  
MANICO MISCELATORE DA INCASSO NERO

---

**1520NG**



**VOLANTE EMPOTRAR MM BLANCO**  
CONCEALED SINGLE LEVER HANDLE WHITE  
POIGNÉE MITIGEUR À ENCASTRER BLANC  
MANICO MISCELATORE DA INCASSO BIANCO

---

**1520BL**



**VOLANTE SELECTOR MM ONNA-RIO**  
ONNA-RIO SINGLE LEVER HANDLE SELECTOR  
POIGNÉE SÉLECTEUR MITIGEUR ONNA-RIO  
MANICO SELETTORE MISCELATORE ONNA-RIO

---

**1527**



**PALANCA REGULACIÓN CAUDAL TERM. EMP.**  
FLOW REGULATION LEVER TO CONCEALED  
THERM.  
LEVIER RÉGULATION DÉBIT THERMO. ENC.  
LEVA REGOLAZIONE FLUSSO TERMO. INC.

---

**1528**



**VOLANTE SELECTOR LUXOR MM**  
LUXOR SINGLE LEVER SELECTOR HANDLE  
POIGNÉE SÉLECTEUR MITIGEUR LUXOR  
MANICO SELETTORE MISCELATORE LUXOR

---

**1529**



**VOLANTE SELECTOR QUS MM**  
QUS SINGLE LEVER SELECTOR HANDLE  
POIGNÉE SÉLECTEUR MITIGEUR QUS  
MANICO SELETTORE MISCELATORE QUS

---

**1529NG**



**VOLANTE REGULACIÓN CAUDAL TERM. AURA**  
FLOW REGULATION HANDLE AURA THERM.  
POIGNÉE RÉGULATION DÉBIT THERMO. AURA  
MANICO REGOLAZIONE FLUSSO TERMO. AURA

---

**1530**



**VOLANTE TERMOSTÁTICO AURA**  
AURA THERMOSTATIC HANDLE  
POIGNÉE THERMOSTATIQUE AURA  
MANICO TERMOSTATICO AURA

---

**1531**



**VOLANTE TERM. NITE NEGRO**  
NITE THERM. HANDLE BLACK  
POIGNÉE THERMO. NITE NOIRE  
MANICO TERMO. NITE NERO

---

**1532NG**



**VOLANTE TERM. NITE BLANCO**  
NITE THERM. HANDLE WHITE  
POIGNÉE THERMO. NITE BLANC  
MANICO TERMO. NITE BIANCO

---

**1532BL**



**VOLANTE TERM. QUARK**  
QUARK THERM. HANDLE  
POIGNÉE THERMO. QUARK  
MANICO TERMO. QUARK

---

**1534**



**VOLANTE ON-OFF QUARK**  
QUARK ON-OFF HANDLE  
POIGNÉE ON-OFF QUARK  
MANICO ON-OFF QUARK

---

**1535**



**VOLANTE SELECTOR BAÑO TERM. ARTIC**  
ARTIC THERM. BATH SELECTOR HANDLE  
POIGNÉE SÉLECTEUR BAIN THERMO. ARTIC  
MANICO SELETTORE VASCA TERMO. ARTIC

---

**1536**



**VOLANTE TERMOSTÁTICO ESCADE**  
ESCADE THERMOSTATIC HANDLE  
POIGNÉE THERMOSTATIQUE ESCADE  
MANICO TERMOSTATICO ESCADE

---

**1538**



**VOLANTE TERMOSTÁTICO ESCADE NEGRO**  
ESCADE THERMOSTATIC HANDLE BLACK  
POIGNÉE THERMOSTATIQUE ESCADE NOIRE  
MANICO TERMOSTATICO ESCADE NEGRO

---

**1538NG**



**VOLANTE ON-OFF ESCADE**  
ESCADE ON-OFF HANDLE  
POIGNÉE ON-OFF ESCADE  
MANICO ON-OFF ESCADE

---

**1539**



**VOLANTE ON-OFF ESCADE**  
ESCADE ON-OFF HANDLE  
POIGNÉE ON-OFF ESCADE  
MANICO ON-OFF ESCADE

---

**1540**



**VOLANTE ON-OFF ESCADE NEGRO**  
BLACK ESCADE ON-OFF HANDLE  
POIGNÉE ON-OFF ESCADE NOIRE  
MANICO ON-OFF ESCADE NEGRO

---

**1540NG**



**VOLANTE TERMOSTÁTICO ARUM**  
ARUM THERMOSTATIC HANDLE  
POIGNÉE THERMOSTATIQUE ARUM  
MANICO TERMOSTATICO ARUM

---

**1541**



**VOLANTE ON-OFF ARUM**  
ARUM ON-OFF HANDLE  
POIGNÉE ON-OFF ARUM  
MANICO ON-OFF ARUM

---

**1542**



**VOLANTE ON-OFF ARU**  
ARUM ON-OFF HANDLE  
POIGNÉE ON-OFF ARUM  
MANICO ON-OFF ARUM

---

**1543**



**VOLANTE TERMOSTÁTICO NOIR**  
NOIR THERMOSTATIC HANDLE  
POIGNÉE THERMOSTATIQUE NOIR  
MANICO TERMOSTATICO NOIR

---

**1544**



**VOLANTE SELECTOR TERM. NOIR**  
NOIR THERM. HANDLE SELECTOR  
POIGNÉE SÉLECTEUR THERMO. NOIR  
MANICO SELETTORE TERMO. NOIR

---

**1545**



**VOLANTE SELECTOR MM NOIR**  
NOIR SINGLE LEVER HANDLE SELECTOR  
POIGNÉE SÉLECTEUR MITIGEUR NOIR  
NOIR SINGLE LEVA MANICO SELETTORE

---

**1546**



**VOLANTE HOMERO**  
HOMERO HANDLE  
MANETTE HOMERO  
MANIGLIA HOMERO

---

**1827**



**VOLANTE BRISTOL**  
BRISTOL HANDLE  
MANETTE BRISTOL  
MANIGLIA BRISTOL

---

**1927**



**VOLANTE CHRONOS CROMO**  
CHRONOS CHROME HANDLE  
MANETTE CHRONOS CHROME  
MANIGLIA CHRONOS CROMO

---

**1928**



**VOLANTE CHRONOS PLATA**  
CHRONOS SILVER HANDLE  
MANETTE CHRONOS ARGENT  
MANIGLIA CHRONOS ARGENTO

---

**1928AG**



**VOLANTE CHRONOS BRONCE**  
CHRONOS BRONZE HANDLE  
MANETTE CHRONOS BRONZE  
MANIGLIA CHRONOS BRONZO

---

**1928BR**



**VOLANTE CHRONOS COBRE**  
CHRONOS COPPER HANDLE  
MANETTE CHRONOS CUIVRE  
MANIGLIA CHRONOS RAME

---

**1928CU**



**VOLANTE RHODAS CROMO**  
RHODAS CHROME HANDLE  
MANETTE RHODAS CHROME  
MANIGLIA RHODAS CROMO

---

**1929**



**VOLANTE RHODAS BRONCE**  
RHODAS BRONZE HANDLE  
MANETTE RHODAS BRONZE  
MANIGLIA RHODAS BRONZO

---

**1929BR**





















**VOLANTE INDO**  
INDO HANDLE  
MANETTE INDO  
MANIGLIA INDO











---

**1930**

	<b>VOLANTE MAYFAIR CROMO</b> MAYFAIR CHROME HANDLE MANETTE MAYFAIR CHROME MANIGLIA MAYFAIR CROMO	<b>1931</b>
	<b>VOLANTE MAYFAIR PLATA</b> MAYFAIR SILVER HANDLE MANETTE MAYFAIR ARGENT MANIGLIA MAYFAIR ARGENTO	<b>1931AG</b>
	<b>VOLANTE MAYFAIR BRONCE</b> MAYFAIR BRONZE HANDLE MANETTE MAYFAIR BRONZE MANIGLIA MAYFAIR BRONZO	<b>1931BR</b>
	<b>VOLANTE MAYFAIR COBRE</b> MAYFAIR COPPER HANDLE MANETTE MAYFAIR CUIVRE MANIGLIA MAYFAIR RAME	<b>1931CU</b>
	<b>CARTUCHO 35 SALIDA FIJA</b> 35 FLAT BASE CARTRIDGE CARTOUCHE 35 BASE PLATE CARTUCCIA 35 BASE PIATTA	<b>2001</b>
	<b>CARTUCHO 35 JUNTA SUPERIOR</b> 35 SUPERIOR JUNCTION HIGH CARTRIDGE CARTOUCHE 35 JUNTE SUPÉRIEURE BASE HAUTE CARTUCCIA 35 GIUNTA SUPERIORE BASE ALTA	<b>2003</b>
	<b>CARTUCHO 35 SALIDA FIJA D.O.</b> 35 OUTLET IN FRONT CARTRIDGE CARTOUCHE 35 BASE PLATE D.O. CARTUCCIA 35 BASE PIATTA D.O.	<b>2004</b>
	<b>CARTUCHO 40 SALIDA LIBRE</b> 40 HIGH CARTRIDGE CARTOUCHE 40 BASE HAUTE CARTUCCIA 40 BASE ALTA	<b>2005</b>
	<b>CARTUCHO 40 SALIDA FIJA</b> 40 FLAT BASE CARTRIDGE CARTOUCHE 40 BASE PLATE CARTUCCIA 40 BASE PIATTA	<b>2006</b>
	<b>CARTUCHO 35 ECO (FREGADERAS)</b> 35 ECO CARTRIDGE (SINK) CARTOUCHE ECO 35 (ÉVIER) CARTUCCIA ECO 35 (LAVELLO)	<b>2009</b>
	<b>CARTUCHO 35 SALIDA FIJA AP. EN FRÍO</b> 35 COLD WATER OPENING CARTRIDGE CARTOUCHE 35 BASE PLATE OUVERTURE FROIDE CARTUCCIA 35 BASE PIATTA APERTURA FREDDA	<b>2010</b>

	<b>CARTUCHO 35 ECO ALTO (FREGADERAS)</b> 35 HIGH ECO CARTRIDGE (SINK) CARTOUCHE ECO 35 BASE HAUTE (ÉVIER) CARTUCCIA ECO 35 BASE ALTA (LAVELLO)	<b>2011</b>
	<b>CARTUCHO 35 JUNTA SUPERIOR</b> 35 SUPERIOR JUNCTION CARTRIDGE CARTOUCHE 35 JUNTE SUPÉRIEURE CARTUCCIA 35 GIUNTA SUPERIORE	<b>2013</b>
	<b>CARTUCHO 40 ECO</b> 40 ECO CARTRIDGE CARTOUCHE ECO 40 CARTUCCIA ECO 40	<b>2014</b>
	<b>CARTUCHO 25 JUNTA SUPERIOR</b> 25 SUPERIOR JUNCTION CARTRIDGE CARTOUCHE 25 JUNTE SUPÉRIEURE CARTUCCIA 25 GIUNTA SUPERIORE	<b>2015</b>
	<b>CARTUCHO 30 SALIDA FIJA</b> 30 FLAT BASE CARTRIDGE CARTOUCHE 30 BASE PLATE CARTUCCIA 30 BASE PIATTA	<b>2016</b>
	<b>CARTUCHO 35 ROTATIVO</b> 35 ROTATIVE CARTRIDGE CARTOUCHE 35 ROTATIVE CARTUCCIA 35 ROTATIVA	<b>2017</b>
	<b>CARTUCHO TERMOSTÁTICO SIGMA</b> SIGMA THERMOSTATIC CARTRIDGE CARTOUCHE THERMOSTATIQUE SIGMA CARTUCCIA TERMOSTATICA SIGMA	<b>2101</b>
	<b>CARTUCHO TERMOSTÁTICO ARTIC</b> ARTIC THERMOSTATIC CARTRIDGE CARTOUCHE SÉLECTEUR ARTIC BAIN THERMO. CARTUCCIA TERMOSTATICA ARTIC	<b>2102</b>
	<b>CARTUCHO TERMOSTÁTICO</b> THERMOSTATIC CARTRIDGE CARTOUCHE THERMOSTATIQUE CARTUCCIA TERMOSTATICA	<b>2103</b>
	<b>CARTUCHO TERMOSTÁTICO QUARK</b> QUARK THERMOSTATIC CARTRIDGE CARTOUCHE THERMOSTATIQUE QUARK CARTUCCIA TERMOSTATICA QUARK	<b>2105</b>
	<b>CARTUCHO TERMOSTÁTICO LUXOR</b> LUXOR THERMOSTATIC CARTRIDGE CARTOUCHE THERMOSTATIQUE LUXOR CARTUCCIA TERMOSTATICA LUXOR	<b>2107</b>

	<b>CARTUCHO TERM. COLUMNAS</b> COLUMNS THERM. CARTRIDGE CARTOUCHE THERMO. COLONNES. CARTUCCIA TERMO. COLONNE.	<b>2108</b>
	<b>CARTUCHO TERM. EMP. TEMP. Y CAUDAL</b> CONCEALED THERM. CARTRIDGE TEMP. & FLOW CARTOUCHE THERMO. ENC. TEMP. ET DÉBIT CARTUCCIA TERMO. INC. TEMP. E FLUSSO	<b>2110</b>
	<b>CARTUCHO TERMOSTÁTICO QUARK</b> QUARK THERMOSTATIC CARTRIDGE CARTOUCHE THERMOSTATIQUE QUARK CARTUCCIA TERMOSTATICA QUARK	<b>2112</b>
	<b>VOLANTE NITE NEGRO + CARTUCHO TERM</b> NITE BLACK HANDLE + THERM CARTRIDGE POIGNÉE NITE NOIRE + CARTOUCHE THERM MANICO NITE NERO + CARTUCCIA TERM	<b>2115</b>
	<b>CARTUCHO TERMOSTÁTICO NITE BLANCO</b> NITE WHITE THERMOSTATIC CARTRIDGE CARTOUCHE THERMOSTATIQUE NITE BLANC CARTUCCIA TERMOSTATICA NITE BIANCO	<b>2116</b>
	<b>CARTUCHO SELECTOR LUXOR</b> LUXOR SELECTOR CARTRIDGE CARTOUCHE SÉLECTEUR LUXOR CARTUCCIA SELETTORE LUXOR	<b>2200</b>
	<b>CARTUCHO SELECTOR SIGMA</b> SIGMA SELECTOR CARTRIDGE CARTOUCHE SÉLECTEUR SIGMA CARTUCCIA SELETTORE SIGMA	<b>2201</b>
	<b>CARTUCHO SELECTOR ARTIC BAÑO TERM.</b> ARTIC THERM. BATH SELECTOR CARTRIDGE CARTOUCHE SÉLECTEUR ARTIC BAIN THERMO. CARTUCCIA SELETTORE ARTIC VASCA TERMO.	<b>2202</b>
	<b>CARTUCHO SELECTOR ARTIC DUCHA TERM.</b> ARTIC THERM. SHOWER SELECTOR CARTRIDGE CARTOUCHE SÉLECTEUR ARTIC THERMO. DOUCHE CARTUCCIA SELETTORE ARTIC TERMO. DOCCIA	<b>2203</b>
	<b>CARTUCHO SELECTOR ARTIC DUCHA MM</b> ARTIC SINGLE LEVER SHOWER SELECTOR CARTRIDGE CARTOUCHE SÉLECTEUR ARTIC MITIGEUR DOUCHE CARTUCCIA SELETTORE ARTIC MISCELATORE DOCCIA	<b>2204</b>
	<b>CARTUCHO SELECTOR ARTIC BAÑO MM</b> ARTIC SINGLE LEVER BATH SELECTOR CARTRIDGE CARTOUCHE SÉLECTEUR ARTIC MITIGEUR BAIN CARTUCCIA SELETTORE ARTIC MISCELATORE VASCA	<b>2205</b>

	<b>CARTUCHO SELECTOR ONNA MM</b> ONNA SINGLE LEVER SELECTOR CARTRIDGE CARTOUCHE SÉLECTEUR ONNA MITIGEUR CARTUCCIA SELETTORE ONNA MISCELATORE	<b>2208</b>
	<b>CARTUCHO SELECTOR MM-EMP. CUADRADO</b> SQUARE CONCEALED SINGLE LEVER CARTRIDGE SELECTOR CARTOUCHE SÉLECTEUR MITIGEUR À ENCASTREUR CARRÉ CARTUCCIA SELETTORE MISCELATORE DA INCASSO QUADRATO	<b>2214</b>
	<b>CARTUCHO SELECTOR AMBER MM</b> AMBER SINGLE LEVER CARTRIDGE SELECTOR CARTOUCHE SÉLECTEUR AMBER MITIGEUR CARTUCCIA SELETTORE AMBER MISCELATORE	<b>2216</b>
	<b>CARTUCHO SELECTOR EDNA TERM.</b> EDNA THERM. SELECTOR CARTRIDGE CARTOUCHE SÉLECTEUR EDNA THERMO. CARTUCCIA SELETTORE EDNA TERMO.	<b>2217</b>
	<b>CARTUCHO SELECTOR RIO TERM.</b> RIO THERM. SELECTOR CARTRIDGE CARTOUCHE SÉLECTEUR RIO THERMO. CARTUCCIA SELETTORE RIO TERMO.	<b>2218</b>
	<b>CARTUCHO SELECTOR MM-EMP. REDONDO</b> ROUND CONCEALED SINGLE LEVER CARTRIDGE SELECTOR CARTOUCHE SÉLECTEUR MITIGEUR À ENCASTREUR RONDE CARTUCCIA SELETTORE MISCELATORE DA INCASSO ROTONDA	<b>2219</b>
	<b>CARTUCHO SELECTOR RIO MM</b> RIO SINGLE LEVER SELECTOR CARTRIDGE CARTOUCHE SÉLECTEUR RIO MITIGEUR CARTUCCIA SELETTORE RIO MISCELATORE	<b>2220</b>
	<b>CARTUCHO SELECTOR EDNA MM</b> EDNA SINGLE LEVER SELECTOR CARTRIDGE CARTOUCHE SÉLECTEUR EDNA MITIGEUR CARTUCCIA SELETTORE EDNA MISCELATORE	<b>2221</b>
	<b>CARTUCHO SELECTOR ONNA TERM.</b> ONNA THERM. SELECTOR CARTRIDGE CARTOUCHE SÉLECTEUR ONNA THERMO. CARTUCCIA SELETTORE ONNA TERMO.	<b>2222</b>
	<b>CARTUCHO BOTÓN SELECTOR AURA</b> AURA SELECTOR BUTTON CARTRIDGE CARTOUCHE BOUTON SÉLECTEUR AURA CARTUCCIA PULSANTE SELETTORE AURA	<b>2224</b>
	<b>CARTUCHO SELECTOR NOIR MM</b> NOIR SINGLE LEVER SELECTOR CARTRIDGE CARTOUCHE SÉLECTEUR MITIGEUR NOIR CARTUCCIA SELETTORE MISCELATORE NOIR	<b>2226</b>

	<b>CARTUCHO SELECTOR NOIR TERMOSTÁTICA</b> NOIR THERMOSTATIC SELECTOR CARTRIDGE CARTOUCHE SÉLECTEUR THERMO. NOIR CARTUCCIA SELETTORE TERMO. NOIR	<b>2227</b>
	<b>CARTUCHO SELECTOR ESCADE</b> ESCADE SELECTOR CARTRIDGE CARTOUCHE SÉLECTEUR ESCADE CARTUCCIA SELETTORE ESCADE	<b>2228</b>
	<b>CARTUCHO SELECTOR NITE NEGRO</b> BLACK NITE SELECTOR CARTRIDGE CARTOUCHE SÉLECTEUR NITE NOIRE CARTUCCIA SELETTORE NITE NERO	<b>2230</b>
	<b>CARTUCHO SELECTOR NITE BLANCO</b> WHITE NITE SELECTOR CARTRIDGE CARTOUCHE SÉLECTEUR NITE BLANC CARTUCCIA SELETTORE NITE BIANCO	<b>2231</b>
	<b>INVERSOR 3C66</b> 3C66 DIVERTER DÉVIAEUR 3C66 DEVIATORE 3C66	<b>2301</b>
	<b>INVERSOR 3C60</b> 3C60 DIVERTER DÉVIAEUR 3C60 DEVIATORE 3C60	<b>2302</b>
	<b>INVERSOR ALPHA</b> ALPHA DIVERTER DÉVIAEUR ALPHA DEVIATORE ALPHA	<b>2304</b>
	<b>INVERSOR ALPHA NEGRO</b> BLACK ALPHA DIVERTER DÉVIAEUR ALPHA NOIR DEVIATORE ALPHA NERO	<b>2304NG</b>
	<b>INVERSOR COMPACTO</b> COMPACT DIVERTER DÉVIAEUR COMPACT DEVIATORE COMPATTO	<b>2305</b>
	<b>INVERSOR COMPACTO NEGRO</b> BLACK COMPACT DIVERTER DÉVIAEUR COMPACT NOIR DEVIATORE COMPATTO NERO	<b>2305NG</b>
	<b>INVERSOR 3C55</b> 3C55 DIVERTER DÉVIAEUR 3C55 DEVIATORE 3C55	<b>2311</b>

	<b>INVERSOR SPIRIT MONTURA</b> SPIRIT HEADPART DIVERTER DÉVIAEUR TÊTE CÉRAMIQUE SPIRIT DEVIATORE TESTA CERAMICA SPIRIT	<b>2312</b>
	<b>INVERSOR M3/4"x H1/2"</b> M3/4"x H1/2" DIVERTER DÉVIAEUR M3/4"x H1/2" DEVIATORE M3/4"x H1/2"	<b>2405</b>
	<b>INVERSOR M3/4"x H1/2"</b> M3/4"x H1/2" DIVERTER DÉVIAEUR M3/4"x H1/2" DEVIATORE M3/4"x H1/2"	<b>2406</b>
	<b>INVERSOR A PARED OCEAN</b> OCEAN WALL DIVERTER DÉVIAEUR MURAL OCEAN DEVIATORE A PARETE OCEAN	<b>2407</b>
	<b>INVERSOR A PARED LUXOR</b> LUXOR WALL DIVERTER DÉVIAEUR MURAL LUXOR DEVIATORE A PARETE LUXOR	<b>2408</b>
	<b>INVERSOR A PARED ARTIC</b> ARTIC WALL DIVERTER DÉVIAEUR MURAL ARTIC DEVIATORE A PARETE ARTIC	<b>2413</b>
	<b>PALANCA STUDIO</b> STUDIO LEVER LEVIER STUDIO LEVA STUDIO	<b>2508</b>
	<b>PALANCA TYPE</b> TYPE LEVER LEVIER TYPE LEVA TYPE	<b>2509</b>
	<b>PALANCA LOFT</b> LOFT LEVER LEVIER LOFT LEVA LOFT	<b>2510</b>
	<b>PALANCA ALPHA</b> ALPHA LEVER LEVIER ALPHA LEVA ALPHA	<b>2512</b>
	<b>PALANCA ALPHA NEGRO</b> BLACK ALPHA LEVER LEVIER ALPHA NOIR LEVA ALPHA NERA	<b>2512NG</b>

	<b>PALANCA ALPHA BLANCO</b> WHITE ALPHA LEVER LEVIER ALPHA BLANC LEVA ALPHA BIANCO	<b>2512BL</b>
	<b>PALANCA SOUL</b> SOUL LEVER LEVIER SOUL LEVA SOUL	<b>2513</b>
	<b>PALANCA CELINA</b> CELINA LEVER LEVIER CELINA LEVA CELINA	<b>2515</b>
	<b>PALANCA TIMES</b> TIMES LEVER LEVIER TIMES LEVA TIMES	<b>2516</b>
	<b>PALANCA ARTIC</b> ARTIC LEVER LEVIER ARTIC LEVA ARTIC	<b>2517</b>
	<b>PALANCA FLIX</b> FLIX LEVER LEVIER FLIX LEVA FLIX	<b>2518</b>
	<b>PALANCA TAUS NEGRO</b> BLACK TAUS LEVER LEVIER TAUS NOIR LEVA TAUS NERO	<b>2518NG</b>
	<b>PALANCA WINTER</b> WINTER LEVER LEVIER WINTER LEVA WINTER	<b>2521</b>
	<b>PALANCA WINTER</b> WINTER LEVER LEVIER WINTER LEVA WINTER	<b>2521</b>
	<b>PALANCA INOX TRENT</b> INOX TRENT LEVER LEVIER ACIER INOX TRENT LEVA ACCIAIO INOX TRENT	<b>2522</b>
	<b>PALANCA INOX OSMOSIS</b> S.S. OSMOSIS LEVER LEVIER ACIER INOX OSMOSIS LEVA ACCIAIO INOX OSMOSI	<b>2523</b>

	<b>PALANCA MEDICAL</b> MEDICAL LEVER LEVIER MEDICAL LEVA MEDICALE	<b>2524</b>
	<b>PALANCA LILE INVERTIDA</b> LILE REVERSED LEVER LEVIER INVERSÉ LILE LEVA INVERSA LILE	<b>2526</b>
	<b>PALANCA SALT INVERTIDA</b> SALT REVERSED LEVER LEVIER INVERSÉ SALT LEVA INVERSA SALT	<b>2527</b>
	<b>PALANCA VENT INVERTIDA</b> VENT REVERSED LEVER LEVIER INVERSÉ VENT LEVA INVERSA VENT	<b>2528</b>
	<b>PALANCA MM ONNA</b> ONNA LEVER LEVIER MITIGEUR ONNA LEVA MISCELATORE ONNA	<b>2529</b>
	<b>PALANCA MM EDNA</b> EDNA LEVER LEVIER MITIGEUR EDNA LEVA MISCELATORE EDNA	<b>2530</b>
	<b>PALANCA MM RIO</b> RIO LEVER LEVIER MITIGEUR RIO LEVA MISCELATORE RIO	<b>2531</b>
	<b>PALANCA MM CUADRADA EMPOTRAR</b> SQUARE CONCEALED LEVER LEVIER CARRÉ MITIGEUR À ENCASTRER LEVA QUADRATA MISCELATORE DA INGASSO	<b>2532</b>
	<b>PALANCA SKY</b> SKY LEVER LEVIER SKY LEVA SKY	<b>2535</b>
	<b>PALANCA LILE</b> LILE LEVER LEVIER LILE LEVA LILE	<b>2536</b>
	<b>PALANCA VENT</b> VENT LEVER LEVIER VENT LEVA VENT	<b>2537</b>





**PALANCA GALA**  
GALA LEVER  
LEVIER GALA  
LEVA GALA

2539



**PALANCA GALA INVERTIDA**  
GALA REVERSED LEVER  
LEVIER INVERSÉ GALA  
LEVA INVERSA GALA

2540



**PALANCA VANCOUVER**  
VANCOUVER LEVER  
LEVIER VANCOUVER  
LEVA VANCOUVER

2541



**PALANCA DYNAMO**  
DYNAMO LEVER  
LEVIER DYNAMO  
LEVA DYNAMO

2542



**PALANCA MINIMALISTA**  
MINIMALISTA LEVER  
LEVIER MINIMALISTA  
LEVA MINIMALISTA

2543



**PALANCA SCAPE**  
SCAPE LEVER  
LEVIER SCAPE  
LEVA SCAPE

2544



**PALANCA TUBE GRANDE**  
LARGE TUBE LEVER  
LEVIER TUBE GRAND  
LEVA TUBE GRANDE

2547



**PALANCA TUBE GRANDE NEGRO**  
BLACK LARGE TUBE LEVER  
LEVIER TUBE GRAND NOIR  
LEVA TUBE GRANDE NERA

2547NG



**PALANCA TUBE**  
TUBE LEVER  
LEVIER TUBE  
LEVA TUBE

2548



**PALANCA TUBE NEGRO**  
BLACK TUBE LEVER  
LEVIER TUBE NOIR  
LEVA TUBE NERA

2548NG



**PALANCA METROPOL**  
METROPOL LEVER  
LEVIER METROPOL  
LEVA METROPOL

2550



**PALANCA METROPOL**  
METROPOL LEVER  
LEVIER METROPOL  
LEVA METROPOL

2551

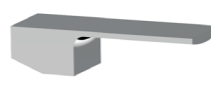

**PALANCA BOLD**  
BOLD LEVER  
LEVIER BOLD  
LEVA BOLD

2553



**PALANCA BOLD NEGRO**  
BOLD BLACK LEVER  
LEVIER BOLD NOIR  
LEVA BOLD NERO

2553NG



**PALANCA ALPHA GRANDE**  
LARGE ALPHA LEVER  
LEVIER ALPHA GRAND  
LEVA ALPHA GRANDE

2554



**PALANCA ALPHA GRANDE BLANCA**  
WHITE LARGE ALPHA LEVER  
LEVIER ALPHA GRAND BLANC  
LEVA ALPHA GRANDE BIANCA

2554BL



**PALANCA ALPHA GRANDE NEGRO**  
BLACK LARGE ALPHA LEVER  
LEVIER ALPHA GRAND NOIR  
LEVA ALPHA GRANDE NERA

2554NG



**PALANCA BETA**  
BETA LEVER  
LEVIER BETA  
LEVA BETA

2555



**PALANCA BETA NEGRO**  
BLACK BETA LEVER  
LEVIER BETA NOIR  
LEVA BETA NERA

2555NG



**PALANCA TRENT CROMO**  
TRENT CHROME LEVER  
LEVIER TRENT CHROMÉ  
LEVA TRENT CROMATA

2556



**PALANCA TRENT NEGRO**  
TRENT BLACK LEVER  
LEVIER TRENT NOIR  
LEVA TRENT NERA

2556NG



**PALANCA TRENT BLANCO**  
TRENT WHITE LEVER  
LEVIER TRENT BLANC  
LEVA TRENT BIANCA

2556BL



**PALANCA BETA GRANDE**  
LARGE BETA LEVER  
LEVIER BETA GRAND  
LEVA BETA GRANDE

2557



**PALANCA BETA GRANDE NEGRO**  
BLACK LARGE BETA LEVER  
LEVIER BETA GRAND NOIR  
LEVA BETA GRANDE NERA

2557NG



**PALANCA LUXOR**  
LUXOR LEVER  
LEVIER LUXOR  
LEVA LUXOR

2558



**PALANCA QUS**  
QUS LEVER  
LEVIER QUS  
LEVA QUS

2558NG



**PALANCA COOK**  
COOK LEVER  
LEVIER COOK  
LEVA COOK

2559



**PALANCA ALPHA INVERTIDA**  
ALPHA REVERSED LEVER  
LEVIER INVERSÉ ALPHA  
LEVA INVERSA ALPHA

2560



**PALANCA ALPHA INVERTIDA NEGRO**  
BLACK ALPHA REVERSED LEVER  
LEVIER INVERSÉ ALPHA NOIR  
LEVA INVERSA ALPHA NERA

2560NG

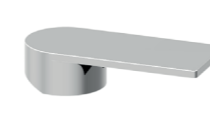

**PALANCA ALPHA GRANDE INVERTIDA**  
LARGE ALPHA REVERSED LEVER  
LEVIER INVERSÉ GRAND ALPHA  
LEVA INVERSA GRANDE ALPHA

2561



**PALANCA ALPHA BLANCO GRANDE INVERTIDA**  
LARGE WHITE ALPHA REVERSED LEVER  
LEVIER INVERSÉ GRAND ALPHA BLANC  
LEVA INVERSA GRANDE ALPHA BIANCA

2561BL



**PALANCA ALPHA GRANDE NEGRO INVERTIDA**  
BLACK LARGE ALPHA REVERSED LEVER  
LEVIER INVERSÉ GRAND ALPHA NOIR  
LEVA INVERSA GRANDE ALPHA NERA

2561NG



**PALANCA TUBE INVERTIDA**  
TUBE REVERSED LEVER  
LEVIER INVERSÉ TUBE  
LEVA INVERSA TUBE

2562



**PALANCA TUBE NEGRO INVERTIDA**  
BLACK TUBE REVERSED LEVER  
LEVIER INVERSÉ TUBE NOIR  
LEVA INVERSA TUBE NERA

2562NG



**PALANCA TUBE GRANDE INVERTIDA**  
LARGE TUBE REVERSED LEVER  
LEVIER INVERSÉ GRAND TUBE  
LEVA INVERSA GRANDE TUBE

2563



**PALANCA TUBE GRANDE NEGRO INVERTIDA**  
BLACK LARGE TUBE REVERSED LEVER  
LEVIER INVERSÉ GRAND TUBE NOIR  
LEVA INVERSA GRANDE TUBE NERA

2563NG



**PALANCA BETA GRANDE INVERTIDA**  
LARGE BETA REVERSED LEVER  
LEVIER INVERSÉ GRAND BETA  
LEVA INVERSA GRANDE BETA

2564



**PALANCA BETA GRANDE INVERTIDA NEGRO**  
BLACK LARGE BETA REVERSED LEVER  
LEVIER INVERSÉ GRAND BETA NOIR  
LEVA INVERSA GRANDE BETA NERA

2564NG



**PALANCA NOIR**  
NOIR LEVER  
LEVIER MITIGEUR NOIR  
LEVA MISCELATORE NOIR

2566

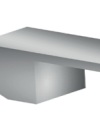

**PALANCA ARES**  
ARES LEVER  
LEVIER MITIGEUR ARES  
LEVA MISCELATORE ARES

2567



**PALANCA ARES NEGRO**  
BLACK ARES LEVER  
LEVIER MITIGEUR ARES NOIR  
LEVA MISCELATORE ARES NERO

2567NG



**PALANCA SORT**  
SORT LEVER  
LEVIER MITIGEUR SORT  
LEVA MISCELATORE SORT

2568



**PALANCA SORT NEGRO**  
BLACK SORT LEVER  
LEVIER MITIGEUR SORT NOIR  
LEVA MISCELATORE SORT NERO

2568NG



**PALANCA ONE**  
ONE LEVER  
LEVIER MITIGEUR ONE  
LEVA MISCELATORE ONE

2570

	<b>PALANCA DELTA GRANDE</b> LARGE DELTA LEVER LEVIER DELTA GRAND LEVA DELTA GRANDE	<b>2574</b>
	<b>PALANCA DELTA</b> DELTA LEVER LEVIER DELTA LEVA DELTA	<b>2576</b>
	<b>PALANCA QB GRANDE</b> LARGE QB LEVER LEVIER QB GRAND LEVA QB GRANDE	<b>2578</b>
	<b>PALANCA QB</b> DELTA QB LEVIER QB LEVA QB	<b>2583</b>
	<b>COBERTOR CARTUCHO 35</b> 35 CARTRIDGE CAP ENJOLIVEUR CARTOUCHE 35 ABBELLIMENTO CARTUCCIA 35	<b>3001</b>
	<b>COBERTOR CARTUCHO 35 NEGRO</b> BLACK 35 CARTRIDGE CAP ENJOLIVEUR CARTOUCHE 35 NOIR ABBELLIMENTO CARTUCCIA 35 NERO	<b>3001NG</b>
	<b>COBERTOR CARTUCHO 35 BLANCO</b> WHITE 35 CARTRIDGE CAP ENJOLIVEUR CARTOUCHE 35 BLANC ABBELLIMENTO CARTUCCIA 35 BIANCO	<b>3001BL</b>
	<b>COBERTOR CARTUCHO SALT</b> SALT CARTRIDGE CAP ENJOLIVEUR CARTOUCHE SALT ABBELLIMENTO CARTUCCIA SALT	<b>3002</b>
	<b>COBERTOR CARTUCHO 40</b> 40 CARTRIDGE CAP ENJOLIVEUR CARTOUCHE 40 ABBELLIMENTO CARTUCCIA 40	<b>3003</b>
	<b>COBERTOR CARTUCHO FLIX</b> FLIX CARTRIDGE CAP ENJOLIVEUR CARTOUCHE FLIX ABBELLIMENTO CARTUCCIA FLIX	<b>3005</b>
	<b>COBERTOR CARTUCHO 25 FLIX NEGRO</b> BLACK FLIX 25 CARTRIDGE CAP ENJOLIVEUR CARTOUCHE 25 FLIX NOIR ABBELLIMENTO CARTUCCIA 25 FLIX NERO	<b>3005NG</b>

	<b>COBERTOR CARTUCHO 25 FLIX BLANCO</b> WHITE FLIX 25 CARTRIDGE CAP ENJOLIVEUR CARTOUCHE 25 FLIX BLANC ABBELLIMENTO CARTUCCIA 25 FLIX BIANCO	<b>3005BL</b>
	<b>COBERTOR CARTUCHO 40 M45</b> 40 M45 CARTRIDGE CAP ENJOLIVEUR CARTOUCHE 40 M45 ABBELLIMENTO CARTUCCIA 40 M45	<b>3007</b>
	<b>COBERTOR CARTUCHO 35 INOX</b> 35 S.S.CARTRIDGE CAP ENJOLIVEUR CARTOUCHE 35 ACIER INOX ABBELLIMENTO CARTUCCIA 35 ACCIAIO INOX	<b>3010</b>
	<b>COBERTOR CARTUCHO 25 BOLD</b> BOLD 25 CARTRIDGE CAP ENJOLIVEUR CARTOUCHE 25 BOLD ABBELLIMENTO CARTUCCIA 25 BOLD	<b>3012</b>
	<b>COBERTOR CARTUCHO 25 BOLD NEGRO</b> BLACK BOLD 25 CARTRIDGE CAP ENJOLIVEUR CARTOUCHE 25 BOLD NOIR ABBELLIMENTO CARTUCCIA 25 BOLD NERO	<b>3012NG</b>
	<b>COBERTOR CARTUCHO 25 BOLD BLANCO</b> WHITE BOLD 25 CARTRIDGE CAP ENJOLIVEUR CARTOUCHE 25 BOLD BLANC ABBELLIMENTO CARTUCCIA 25 BOLD BIANCO	<b>3012BL</b>
	<b>COBERTOR MONTURA ROSCADA BRISTOL</b> BRISTOL HEADPART CAP ENJOLIVEUR TÊTE FILETÉE BRISTOL ABBELLIMENTO TESTA FILETTATA BRISTOL	<b>3013</b>
	<b>COBERTOR DISTRIBUIDOR EMP. MM</b> CONCEALED SINGLE LEVER DIVERTER CAP ENJOLIVEUR DÉVIATEUR MITIGEUR À ENCASTREUR ABBELLIMENTO DEVIATORE MISC. DA INCASSO	<b>3014</b>
	<b>COBERTOR DISTRIBUIDOR EMP. NEGRO</b> BLACK CONC. SINGLE LEVER DIVERTER CAP ENJOLIVEUR DÉVIATEUR MITIGEUR À ENC. NOIR ABBELLIMENTO DEVIATORE MISC. DA INCASSO NERO	<b>3014NG</b>
	<b>COBERTOR DISTRIBUIDOR EMP. BLANCO</b> CONC. SINGLE LEVER DIVERTER CAP WHITE ENJOLIVEUR DÉVIATEUR MITIGEUR À ENC. BLANC ABBELLIMENTO DEVIATORE MISC. DA INCASSO BIANCO	<b>3014BL</b>
	<b>POMO INVERSOR NAUTILUS</b> NAUTILUS DIVERTER KNOB POMMEAU DÉVIATEUR NAUTILUS POMELLO DEVIATORE NAUTILUS	<b>3500</b>

	<b>POMO INVERSOR SPIRIT</b> SPIRIT DIVERTER KNOB POMMEAU DÉVIATEUR SPIRIT POMELLO DEVIATORE SPIRIT	<b>3501</b>
	<b>POMO INVERSOR</b> DIVERTER KNOB POMMEAU DÉVIATEUR POMELLO DEVIATORE	<b>3506</b>
	<b>POMO INVERSOR SKY</b> SKY DIVERTER KNOB POMMEAU DÉVIATEUR SKY POMELLO DEVIATORE SKY	<b>3507</b>
	<b>POMO INVERSOR SALT</b> SALT DIVERTER KNOB POMMEAU DÉVIATEUR SALT POMELLO DEVIATORE SALT	<b>3508</b>
	<b>POMO INVERSOR SALT NEGRO</b> BLACK SALT DIVERTER KNOB POMMEAU DÉVIATEUR SALT NOIR POMELLO DEVIATORE SALT NERO	<b>3508NG</b>
	<b>POMO INVERSOR BOLD</b> BOLD DIVERTER KNOB POMMEAU DÉVIATEUR BOLD POMELLO DEVIATORE BOLD	<b>3510</b>
	<b>POMO INVERSOR BOLD NEGRO</b> BLACK BOLD DIVERTER KNOB POMMEAU DÉVIATEUR BOLD NOIR POMELLO DEVIATORE BOLD NERO	<b>3510NG</b>
	<b>POMO INVERSOR OLYMPIC</b> OLYMPIC DIVERTER KNOB POMMEAU DÉVIATEUR OLYMPIC POMELLO DEVIATORE OLYMPIC	<b>3511</b>
	<b>POMO INVERSOR OLYMPIC NEGRO</b> BLACK OLYMPIC DIVERTER KNOB POMMEAU DÉVIATEUR OLYMPIC NOIR POMELLO DEVIATORE OLYMPIC NERO	<b>3511NG</b>
	<b>POMO INVERSOR QUARK</b> QUARK DIVERTER KNOB POMMEAU DÉVIATEUR QUARK POMELLO DEVIATORE QUARK	<b>3512</b>
	<b>TUERCA CARTUCHO 35</b> 35 CARTRIDGE NUT ÉCROU DE FIXATION CARTOUCHE 35 DADO CARTUCCIA 35	<b>4001</b>

	<b>TUERCA CARTUCHO 40</b> 40 CARTRIDGE NUT ÉCROU DE FIXATION CARTOUCHE 40 DADO CARTUCCIA 40	<b>4002</b>
	<b>TUERCA SELECTOR ARTIC M35</b> M35 NUT SELECTOR ARTIC ÉCROU SÉLECTEUR ARTIC M35 DADO SELETTORE ARTIC M35	<b>4003</b>
	<b>TUERCA SELECTOR ARTIC M24</b> M24 NUT SELECTOR ARTIC ÉCROU SÉLECTEUR ARTIC M24 DADO SELETTORE ARTIC M24	<b>4004</b>
	<b>TUERCA SELECTOR ARTIC CON TÓRICA</b> NUT SELECTOR ARTIC WITH O-RING ÉCROU SÉLECTEUR ARTIC AVEC BAGUE D'ÉTANCHÉITÉ DADO SELETTORE ARTIC CON ANELLO DI TENUTA STANCA	<b>4005</b>
	<b>TUERCA CARTUCHO 35 SALT</b> SALT 35 CARTRIDGE NUT ÉCROU DE FIXATION CARTOUCHE 35 SALT DADO CARTUCCIA 35 SALT	<b>4006</b>
	<b>RACORD DUCHA SUMMER</b> SUMMER SHOWER RACORD RACCORDEMENT SUMMER DOUCHE GIUNTURA SUMMER DOCCIA	<b>4008</b>
	<b>TUERCA CARTUCHO 25 FLIX</b> FLIX 25 CARTRIDGE NUT ÉCROU DE FIXATION CARTOUCHE 25 FLIX DADO CARTUCCIA 25 FLIX	<b>4009</b>
	<b>TUERCA CARTUCHO 40 M45</b> M45 40 CARTRIDGE NUT ÉCROU DE FIXATION CARTOUCHE 40 M45 DADO CARTUCCIA 40 M45	<b>4010</b>
	<b>TUERCA SELECTOR AMBER</b> AMBER SELECTOR NUT ÉCROU SÉLECTEUR AMBER DADO SELETTORE AMBER	<b>4014</b>
	<b>TUERCA CARTUCHO 25 DOBLE ROSCA</b> DOUBLE THREAD 25 CARTRIDGE NUT ÉCROU DE FIXATION CARTOUCHE 25 DOUBLE FILETAGE DADO CARTUCCIA 25 DOPPIO FILETTO	<b>4015</b>
	<b>MACHÓN 1/2"x 1/2" PARA MIXIS</b> RACORD 1/2" x 1/2" FOR MIXIS RACCORD 1/2"x 1/2" POUR MIXIS GIUNTURA 1/2" x 1/2" PER MIXIS	<b>4017</b>

	<b>TUERCA CARTUCHO 25 DOBLE ROSCA M28M30</b> DOUBLE THREAD 25 CARTRIDGE NUT M28M30 ÉCROU DE FIXATION CARTOUCHE 25 DOUBLE FILETAGE M28M30 DADO CARTUCCIA 25 DOPPIO FILETTO M28M30		<b>CAJA ELECTRÓNICA 1 AGUA</b> ELECTONIC BOX COLD WATER BOÎTE ÉLECTRONIQUE 1 EAU SCATOLA ELETTRONICA 1 ACQUA		<b>PLACA CUADRADA MM EMPOTRAR</b> SINGLE LEVER CONCEALED SQUARE FLANGE PLAQUETTE CARRÉE MITIGEUR À ENCASTRER PIASTRA QUADRATA MISCELATORE DA INCASSO		<b>EMBELLECEDOR MM EDNA FR.</b> EDNA SINGLE LEVER FLANGE FR. ENJOLIVEUR EDNA FR. MITIGEUR ABBELLIMENTO EDNA FR. MISCELATORE
4019		4513		5009		5019	
	<b>TUERCA CARTUCHO 30 DOBLE ROSCA M28M32</b> DOUBLE THREAD 30 CARTRIDGE NUT M28M32 ÉCROU DE FIXATION CARTOUCHE 30 DOUBLE FILETAGE M28M32 DADO CARTUCCIA 30 DOPPIO FILETTO M28M32		<b>CAJA ELECTRÓNICA 2 AGUAS</b> ELECTONIC BOX COLD/HOT WATER BOÎTE ÉLECTRONIQUE 2 EAUX SCATOLA ELETTRONICA 2 ACQUE		<b>PLACA CUADRADA MM EMPOTRAR NEGRO</b> BLACK SINGLE LEVER CONCEALED SQUARE FLANGE PLAQUETTE CARRÉE MITIGEUR À ENCASTRER NOIRE PIASTRA QUADRATA MISCELATORE DA INCASSO NERA		<b>EMBELLECEDOR SELECTOR MM EDNA FR.</b> EDNA SINGLE LEVER SELECTOR FLANGE FR. ENJOLIVEUR EDNA FR. MITIGEUR ABBELLIMENTO SELETTTORE EDNA FR. MISCELATORE
4020		4514		5009NG		5020	
	<b>TUERCA 3/4" BARRA</b> 3/4" NUT BAR ÉCROU 3/4" POUR BARRE DADO 3/4" BARRA		<b>EMBELLECEDOR TERM. ONNA</b> ONNA THERMOSTATIC FLANGE ENJOLIVEUR ONNA THERMO. ABBELLIMENTO ONNA TERMO.		<b>PLACA CUADRADA MM EMPOTRAR BLANCO</b> WHITE SINGLE LEVER CONCEALED SQUARE FLANGE PLAQUETTE CARRÉE MITIGEUR À ENCASTRER BLANCHE PIASTRA QUADRATA MISCELATORE DA INCASSO BIANCA		<b>EMBELLECEDOR TERM. ONNA FR.</b> ONNA THERM. FLANGE FR. ENJOLIVEUR ONNA FR. THERMO. ABBELLIMENTO ONNA FR. TERMO.
4022		5000		5009BL		5021	
	<b>TUERCA 3/4" BARRA NEGRA</b> 3/4" BLACK NUT BAR ÉCROU 3/4" POUR BARRE NOIRE DADO 3/4" BARRA NERA		<b>EMBELLECEDOR TERM. EDNA-RIO</b> EDNA-RIO THERMOSTATIC FLANGE ENJOLIVEUR EDNA-RIO THERMO. ABBELLIMENTO EDNA-RIO TERMO.		<b>PLACA REDONDA MM EMPOTRAR</b> SINGLE LEVER CONCEALED ROUND FLANGE PLAQUETTE RONDE MITIGEUR À ENCASTRER PIASTRA ROTONDA MISCELATORE DA INCASSO		<b>EMBELLECEDOR SELECTOR TERM. ONNA FR.</b> ONNA THERM. SELECTOR FLANGE FR. ENJOLIVEUR SELECTEUR ONNA FR. THERMO. ABBELLIMENTO SELETTTORE ONNA FR. TERMO.
4022NG		5001		5010		5022	
	<b>TUERCA 3/4" BARRA BLANCO</b> 3/4" WHITE NUT BAR ÉCROU 3/4" POUR BARRE BLANC DADO 3/4" BARRA BIANCA		<b>EMBELLECEDOR SELECTOR TERM. ONNA</b> ONNA THERMOSTATIC SELECTOR FLANGE ENJOLIVEUR SELECTEUR ONNA THERMO. ABBELLIMENTO SELETTTORE ONNA TERMO.		<b>PLACA REDONDA MM EMPOTRAR</b> SINGLE LEVER CONCEALED ROUND FLANGE PLAQUETTE RONDE MITIGEUR À ENCASTRER PIASTRA ROTONDA MISCELATORE DA INCASSO		<b>FLORÓN CÓNICO</b> FLANGE ENJOLIVEUR EXCENTRIQUE CONIQUE ABBELLIMENTO ECCENTRICO CONICO
4022BL		5002		5011		5500	
	<b>ASIENTO UNIÓN BARRA</b> SEAT JOIN FOR BAR SIÈGE UNION BARRE SEDILE UNIONE BARRA		<b>EMBELLECEDOR SELECTOR TERM. EDNA-RIO</b> EDNA-RIO THERM. SELECTOR FLANGE ENJOLIVEUR SELECTEUR EDNA-RIO THERMO. ABBELLIMENTO SELETTTORE EDNA-RIO TERMO.		<b>PLACA OVALADA MM EMPOTRAR NEGRO</b> BLACK SINGLE LEVER CONCEALED OVAL FLANGE PLAQUETTE RONDE MITIGEUR À ENCASTRER NOIRE PIASTRA ROTONDA MISCELATORE DA INCASSO NERA		<b>FLORÓN REDONDO</b> ROUND FLANGE ENJOLIVEUR EXCENTRIQUE ROND ABBELLIMENTO ECCENTRICO ROTONDO
4024		5003		5011NG		5501	
	<b>PORTACADENA</b> CHAIN HOLDER PORTE-CHAÎNE PORTACATENA		<b>EMBELLECEDOR SELECTOR MM EDNA-RIO</b> EDNA-RIO SINGLE LEVER SELECTOR FLANGE ENJOLIVEUR SELECTEUR EDNA-RIO MITIGEUR ABBELLIMENTO SELETTTORE EDNA-RIO MISCELATORE		<b>EMBELLECEDOR MM RIO FR.</b> RIO SINGLE LEVER FLANGE FR. ENJOLIVEUR RIO FR. MITIGEUR ABBELLIMENTO RIO FR. MISCELATORE		<b>FLORÓN REDONDO NEGRO</b> BLACK ROUND S-COUPLING FLANGE ENJOLIVEUR EXCENTRIQUE ROND NOIR ABBELLIMENTO ECCENTRICO ROTONDO NERO
4500		5004		5012		5501NG	
	<b>PORTACADENA NEGRO</b> BLACK CHAIN HOLDER PORTE-CHAÎNE NOIR PORTACATENA NERO		<b>EMBELLECEDOR SELECTOR MM ONNA</b> ONNA SINGLE LEVER SELECTOR FLANGE ENJOLIVEUR SELECTEUR ONNA MITIGEUR ABBELLIMENTO SELETTTORE ONNA MISCELATORE		<b>EMBELLECEDOR SELECTOR MM RIO FR.</b> RIO SINGLE LEVER SELECTOR FLANGE FR. ENJOLIVEUR SELECTEUR RIO FR. MITIGEUR ABBELLIMENTO SELETTTORE RIO FR. MISCELATORE		<b>FLORÓN REDONDO BLANCO</b> WHITE ROUND S-COUPLING FLANGE ENJOLIVEUR EXCENTRIQUE ROND BLANC ABBELLIMENTO ECCENTRICO ROTONDO BIANCO
4500NG		5005		5015		5501BL	
	<b>PORTACADENA BLANCO</b> WHITE CHAIN HOLDER PORTE-CHAÎNE BLANC PORTACATENA BIANCO		<b>EMBELLECEDOR MM EDNA-RIO</b> EDNA-RIO SINGLE LEVER FLANGE ENJOLIVEUR EDNA-RIO MITIGEUR ABBELLIMENTO EDNA-RIO MISCELATORE		<b>PLACA OVALADA TERM. EMP.</b> THERM. CONCEALED OVAL FLANGE PLAQUETTE RONDE THERMO. À ENCASTRER PIASTRA ROTONDA TERMO. DA INCASSO		<b>FLORÓN CUADRADO</b> SQUARE FLANGE ENJOLIVEUR EXCENTRIQUE CARRÉ ABBELLIMENTO ECCENTRICO QUADRATO
4500BL		5006		5016		5502	
	<b>EJE PEDAL AZUL</b> BLUE FOOT LEVER LEVIER ROBINET À PÉDALE BLEU LEVA RUBINETTO A PEDALE BLU		<b>EMBELLECEDOR MM ONNA</b> ONNA SINGLE LEVER FLANGE ENJOLIVEUR ONNA MITIGEUR ABBELLIMENTO ONNA MISCELATORE		<b>PLACA OVALADA TERM. EMP.</b> THERM. CONCEALED OVAL FLANGE PLAQUETTE RONDE THERMO. À ENCASTRER PIASTRA ROTONDA TERMO. DA INCASSO		<b>FLORÓN CUADRADO NEGRO</b> BLACK SQUARE FLANGE ENJOLIVEUR EXCENTRIQUE CARRÉ NOIRE ABBELLIMENTO ECCENTRICO QUADRATO NERO
4501		5007		5017		5502NG	
	<b>EJE PEDAL ROJO</b> RED FOOT LEVER LEVIER ROBINET À PÉDALE ROUGE LEVA RUBINETTO A PEDALE ROSSA		<b>PLACA CUADRADA MM EMPOTRAR</b> SINGLE LEVER CONCEALED SQUARE FLANGE PLAQUETTE CARRÉE MITIGEUR À ENCASTRER PIASTRA QUADRATA MISCELATORE DA INCASSO		<b>PLACA OVALADA LAVABO</b> BASIN CONCEALED OVAL FLANGE PLAQUETTE OVALE MITIGEUR À ENCASTRER PIASTRA OVALE MISCELATORE DA INCASSO		<b>TAPA VOLANTE OLYMPIC</b> OLYMPIC HANDLE COVER CAPUCHON POIGNÉE OLYMPIC COPERTURA MANICO OLYMPIC
4502		5008		5018		5505	

	<b>TAPA VOLANTE NITE NEGRO</b> BLACK NITE HANDLE COVER CAPUCHON POIGNÉE NITE NOIRE COPERTURA MANICO NITE NERO	<b>5505NG</b>
	<b>TAPA VOLANTE NITE BLANCO</b> WHITE NITE HANDLE COVER CAPUCHON POIGNÉE NITE BLANC COPERTURA MANICO NITE BIANCO	<b>5505BL</b>
	<b>TAPA VOLANTE QUARK</b> QUARK HANDLE COVER CAPUCHON POIGNÉE QUARK COPERTURA MANICO QUARK	<b>5506</b>
	<b>TAPA VOLANTE QUARK BAÑO</b> QUARK BATH HANDLE COVER CAPUCHON POIGNÉE QUARK BAIN COPERTURA MANICO QUARK VASCA	<b>5507</b>
	<b>TAPA VOLANTE SIGMA</b> SIGMA HANDLE COVER CAPUCHON POIGNÉE SIGMA COPERTURA MANICO SIGMA	<b>5508</b>
	<b>TAPA VOLANTE LUXOR</b> LUXOR HANDLE COVER CAPUCHON POIGNÉE LUXOR COPERTURA MANICO LUXOR	<b>5509</b>
	<b>TAPA VOLANTE QUS</b> QUS HANDLE COVER CAPUCHON POIGNÉE QUS COPERTURA MANICO QUS	<b>5509NG</b>
	<b>SOPORTE DESLIZANTE UNIVERSAL</b> UNIVERSAL SLIDING SHOWER BRACKET GLISSEUR DOUCHE UNIVERSEL SUPPORTO SCORREVOLE UNIVERSALE	<b>5510</b>
	<b>SOPORTE DESLIZANTE UNIVERSAL BLANCO</b> WHITE UNIVERSAL SLIDING SHOWER BRACKET GLISSEUR DOUCHE UNIVERSEL BLANC SUPPORTO SCORREVOLE UNIVERSALE BIANCO	<b>5510BL</b>
	<b>SOPORTE DESLIZANTE UNIVERSAL NEGRO</b> BLACK UNIVERSAL SLIDING SHOWER BRACKET GLISSEUR DOUCHE UNIVERSEL NOIR SUPPORTO SCORREVOLE UNIVERSALE NERO	<b>5510NG</b>
	<b>SOPORTE DESLIZANTE LUXOR</b> LUXOR SLIDING SHOWER BRACKET GLISSEUR DOUCHE LUXOR SUPPORTO SCORREVOLE LUXOR	<b>5511</b>

	<b>SOPORTE DESLIZANTE LUXOR ABS</b> ABS LUXOR SLIDING SHOWER BRACKET GLISSEUR DOUCHE LUXOR ABS SUPPORTO SCORREVOLE LUXOR ABS	<b>5529</b>
	<b>SOPORTE DESLIZANTE QUS ABS NEGRO</b> BLACK QUS ABS SLIDING SHOWER BRACKET GLISSEUR DOUCHE QUS ABS NOIRE SUPPORTO SCORREVOLE QUS ABS NERO	<b>5529NG</b>
	<b>SOPORTE FIJACIÓN PACIFIC</b> PACIFIC FIXING BRACKET SUPPORT AU MUR PACIFIC SUPPORTO A PARETE PACIFIC	<b>5513</b>
	<b>SOPORTE FIJACIÓN PACIFIC NEGRO</b> BLACK PACIFIC FIXING BRACKET SUPPORT AU MUR PACIFIC NOIR SUPPORTO A PARETE PACIFIC NERO	<b>5513NG</b>
	<b>SOPORTE FIJACIÓN LUXOR</b> LUXOR FIXING BRACKET SUPPORT AU MUR LUXOR SUPPORTO A PARETE LUXOR	<b>5514</b>
	<b>SOPORTE FIJACIÓN QUS</b> QUS FIXING BRACKET SUPPORT AU MUR QUS SUPPORTO A PARETE QUS	<b>5514NG</b>
	<b>SOPORTE FIJACIÓN BERENICE</b> BERENICE FIXING BRACKET SUPPORT AU MUR BERENICE SUPPORTO A PARETE BERENICE	<b>5515</b>
	<b>SOPORTE FIJACIÓN BERENICE NEGRO</b> BLACK BERENICE FIXING BRACKET SUPPORT AU MUR BERENICE NOIRE SUPPORTO A PARETE BERENICE NERO	<b>5515NG</b>
	<b>SOPORTE FIJACIÓN BERENICE BLANCO</b> WHITE BERENICE FIXING BRACKET SUPPORT AU MUR BERENICE BLANC SUPPORTO A PARETE BERENICE BIANCO	<b>5515BL</b>
	<b>TAPA VOLANTE ESCADE</b> ESCADE HANDLE COVER CAPUCHON POIGNÉE ESCADE COPERTURA MANICO ESCADE	<b>5524</b>
	<b>TAPA VOLANTE ESCADE NEGRO</b> BLACK ESCADE HANDLE COVER CAPUCHON POIGNÉE ESCADE NOIRE COPERTURA MANICO ESCADE NERO	<b>5524NG</b>

	<b>AIREADOR M24x1</b> AERATOR M24x1 AÉRATEUR M24x1 AERATORE M24x1	<b>6000</b>
	<b>AIREADOR M24x1 COBRE</b> AERATOR M24x1 COPPER AÉRATEUR M24x1 CUIVRE AERATORE M24x1 RAME	<b>6000CU</b>
	<b>AIREADOR M28x1</b> AERATOR M28x1 AÉRATEUR M28x1 AERATORE M28x1	<b>6001</b>
	<b>AIREADOR M22x1</b> AERATOR M22x1 AÉRATEUR M22x1 AERATORE M22x1	<b>6002</b>
	<b>AIREADOR M22x1 COBRE</b> COPPER AERATOR M22x1 AÉRATEUR M22x1 CUIVRE AERATORE M22x1 RAME	<b>6002CU</b>
	<b>AIREADOR M22x1 CILINDRICO</b> AERATOR M22x1 AÉRATEUR M22x1 CYLINDRIQUE AERATORE M22x1 CILINDRICO	<b>6004</b> <b>1,94</b>
	<b>AIREADOR M24x1 INOX</b> AERATOR M24x1 STAINLESS STEEL AÉRATEUR M24x1 INOX AERATORE M24x1 INOX	<b>6005</b>
	<b>AIREADOR M18x1 INOX</b> AERATOR M18x1 STAINLESS STEEL AÉRATEUR M18x1 INOX AERATORE M18x1 INOX	<b>6006</b>
	<b>AIREADOR M22x1 CILINDRICO INOX</b> AERATOR M22x1 STAINLESS STEEL AÉRATEUR M22x1 CYLINDRIQUE INOX AERATORE M22x1 CILINDRICO INOX	<b>6007</b>
	<b>LLAVE AIREADOR OCULTO</b> HIDDEN AERATOR KEY CLÉ D'AÉRATEUR CACHÉE CHIAVE AERATORE NASCOSTA	<b>6008</b>
	<b>AIREADOR MAYFAIR CROMO</b> MAYFAIR AERATOR CHROME AÉRATEUR MAYFAIR CHROME AERATORE MAYFAIR CROMO	<b>6009</b>

	<b>AIREADOR MAYFAIR PLATA</b> MAYFAIR AERATOR SILVER AÉRATEUR MAYFAIR ARGENT AERATORE A MAYFAIR ARGENTO	<b>6009AG</b>
	<b>AIREADOR MAYFAIR BRONCE</b> MAYFAIR AERATOR BRONZE AÉRATEUR MAYFAIR BRONZE AERATORE MAYFAIR BRONZO	<b>6009BR</b>
	<b>AIREADOR MAYFAIR COBRE</b> MAYFAIR AERATOR COPPER AÉRATEUR MAYFAIR CUIVRE AERATORE MAYFAIR RAME	<b>6009CU</b>
	<b>AIREADOR M24x1 OCULTO</b> HIDDEN AERATOR M24x1 AÉRATEUR M24x1 CACHE AERATORE M24x1 NASCOSTO	<b>6010</b>
	<b>ROTULA BIDÉ CON AIREADOR M24x24</b> BIDET SWIVEL WITH AERATOR M24x24 ROTULE BIDET AVEC AÉRATEUR M24x24 SNODO SFERICO BIDET CON AERATORE M24x24	<b>6011</b>
	<b>ROTULA BIDÉ CON AIREADOR M24xM24 COBRE</b> COPPER BIDET SWIVEL WITH AERATOR M24x24 ROTULE BIDET AVEC AÉRATEUR M24xM24 CUIVRE SNODO SFERICO BIDET CON AERATORE M24xM24 RAME	<b>6011CU</b>
	<b>AIREADOR M20x1 INOX</b> AERATOR M20x1 STAINLESS STEEL AÉRATEUR M20x1 INOX AERATORE M20x1 INOX	<b>6012</b>
	<b>ROTULA BIDÉ CON AIREADOR M24xM20</b> BIDET SWIVEL WITH AERATOR M24xM20 ROTULE BIDET AVEC AÉRATEUR M24xM20 SNODO SFERICO BIDET CON AERATORE M24xM20	<b>6013</b>
	<b>AIREADOR M24x1 DOS FUNCIONES WOLLOBY</b> WOLLOBY 2 FUNCTIONS AERATOR M24x1 AÉRATEUR M24x1 DEUX FONCTIONS WOLLOBY AERATORE M24x1 DUE FUNZIONI WOLLOBY	<b>6014</b>
	<b>AIREADOR M20x1</b> AERATOR M20x1 AÉRATEUR M20x1 AERATORE M20x1	<b>6015</b>
	<b>ROTULA BIDÉ CON AIREADOR M18xM16</b> BIDET SWIVEL WITH AERATOR M18xM16 ROTULE BIDET AVEC AÉRATEUR M18xM16 SNODO BIDET CON AERATORE M18xM16	<b>6016</b>

	<b>ROTULA BIDÉ CON AIREADOR M18xM16 NEGRO</b> BLACK BIDET SWIVEL WITH AERATOR M18xM16 ROTULE BIDET AVEC AÉRATEUR M18xM16 NOIR SNODO BIDET CON AERATORE M18xM16 NERO
<b>6016NG</b>	
	<b>ROTULA BIDÉ CON AIREADOR M18xM16 BLANCO</b> WHITE BIDET SWIVEL WITH AERATOR M18xM16 ROTULE BIDET AVEC AÉRATEUR M18xM16 BLANC SNODO BIDET CON AERATORE M18xM16 BIANCO
<b>6016BL</b>	
	<b>AIREADOR M18x1 OCULTO</b> HIDDEN AERATOR M18x1 AÉRATEUR M18x1 CACHÉ AERATORE M18x1 NASCOSTO
<b>6017</b>	
	<b>ROTULA BIDÉ CON AIREADOR 18x20</b> BIDET SWIVEL WITH AERATOR M18xM20 ROTULE BIDET AVEC AÉRATEUR M18xM20 SNODO BIDET CON AERATORE M18xM20
<b>6020</b>	
	<b>ROTULA BIDÉ CON AIREADOR 18x20 NEGRO</b> BLACK BIDET SWIVEL WITH AERATOR M18xM20 ROTULE BIDET AVEC AÉRATEUR M18xM20 NOIRE SNODO BIDET CON AERATORE M18xM20 NERO
<b>6020NG</b>	
	<b>AIREADOR M24x1 OCULTO UNIVERSAL</b> UNIVERSAL HIDDEN AERATOR M24x1 AÉRATEUR M24x1 CACHÉ UNIVERSEL AERATORE M24x1 NASCOSTO UNIVERSALE
<b>6021</b>	
	<b>ROTULA BIDÉ RECTANGULAR</b> RECTANGULAR BIDET SWIVEL ROTULE BIDET RECTANGULAIRE SNODO BIDET RETTANGOLARE
<b>6026</b>	
	<b>ROTULA BIDÉ CON AIREADOR 24x22</b> BIDET SWIVEL WITH AERATOR 24x22 ROTULE BIDET AVEC AÉRATEUR 24x22 SNODO BIDET CON AERATORE 24x22
<b>6028</b>	
	<b>PEANA UNIVERSAL</b> UNIVERSAL BASE BASE UNIVERSEL BASE UNIVERSALE
<b>6500</b>	
	<b>PEANA BASE</b> BASE BASE BASE BASE BASE BASE
<b>6503</b>	
	<b>PEANA MINIMALISTA</b> MINIMALIST BASE BASE MINIMALISTA BASE MINIMALISTA
<b>6504</b>	

	<b>PEANA SOUL</b> SOUL BASE BASE SOUL BASE SOUL
<b>6505</b>	
	<b>PEANA GALA EXTRAIBLE</b> GALA PULL OUT BASE BASE GALA EXTRACTIBLE BASE GALA RIMOVIBILE
<b>6506</b>	
	<b>PEANA GALA GIRAT. OVAL</b> GALA SINK MIXER BASE BASE GALA RONDE ROTATIVE BASE GALA ROTONDA GIREVOLE
<b>6507</b>	
	<b>PEANA CELINA</b> CELINA BASE BASE CELINA BASE CELINA
<b>6508</b>	
	<b>PEANA GALA FRONTAL EXTRAIBLE</b> GALA PULL OUT BASE BASE GALA FRONTALE EXTRACTIBLE BASE GALA FRONTALE RIMOVIBILE
<b>6509</b>	
	<b>PEANA CUADRADA METROPOL</b> METROPOL SQUARE BASE BASE CARRÉE METROPOL BASE QUADRATA METROPOL
<b>6511</b>	
	<b>PEANA CUADRADA ALPHA</b> ALPHA SQUARE BASE BASE CARRÉE ALPHA BASE QUADRATA ALPHA
<b>6512</b>	
	<b>PEANA CUADRADA ALPHA NEGRO</b> BLACK ALPHA SQUARE BASE BASE CARRÉE ALPHA NOIRE BASE QUADRATA ALPHA NERA
<b>6512NG</b>	
	<b>PEANA CUADRADA ALPHA BLANCO</b> WHITE ALPHA SQUARE BASE BASE CARRÉE ALPHA BLANCHE BASE QUADRATA ALPHA BIANCO
<b>6512BL</b>	
	<b>PEANA REDONDA TUBE</b> TUBE ROUND BASE BASE RONDE TUBE BASE ROTONDA TUBE
<b>6513</b>	
	<b>PEANA REDONDA TUBE NEGRO</b> BLACK TUBE ROUND BASE BASE RONDE TUBE NOIRE BASE ROTONDA TUBE NERA
<b>6513NG</b>	

	<b>PEANA CUADRADA BOLD</b> BOLD SQUARE BASE BASE CARRÉE BOLD BASE QUADRATA BOLD
<b>6514</b>	
	<b>PEANA CUADRADA BOLD NEGRO</b> BLACK BOLD SQUARE BASE BASE CARRÉE BOLD NOIRE BASE QUADRATA BOLD NERO
<b>6514NG</b>	
	<b>PEANA CUADRADA DELTA</b> DELTA SQUARE BASE BASE CARRÉE DELTA BASE QUADRATA DELTA
<b>6515</b>	
	<b>PEANA REDONDA SORT</b> SORT ROUND BASE BASE RONDE SORT BASE ROTONDA SORT
<b>6516</b>	
	<b>PEANA REDONDA SORT NEGRO</b> BLACK SORT ROUND BASE BASE RONDE SORT NOIRE BASE ROTONDA SORT NERA
<b>6516NG</b>	
	<b>JUNTA FILTRO TERMOSTÁTICAS</b> THERMOSTATIC FILTER JOINT JOINT FILTRE THERMOSTATIQUE GIUNTO FILTRO TERMOSTATICO
<b>7000</b>	
	<b>JUNTA FILTRO TERM. ARTIC</b> ARTIC THERMOSTATIC FILTER JOINT JOINT FILTRE THERMOSTATIQUE ARTIC GIUNTO FILTRO TERMOSTATICO ARTIC
<b>7001</b>	
	<b>JUNTA PLANA 1/2"</b> 1/2" FLAT JOINT JOINT PLAT 1/2" GIUNTO PIATTO 1/2"
<b>7002</b>	
	<b>JUNTA PLANA 3/4"</b> 3/4" FLAT JOINT JOINT PLAT 3/4" GIUNTO PIATTO 3/4"
<b>7003</b>	
	<b>LATIGUILLO M10 x 3/8" x 350</b> 350 FLEXIBLE CONNECTOR M10x3/8" FLEXIBLE DE RACCORDEMENT M10x3/8" x 350 FLESSIBILE DI RACCORDO M10x3/8" x 350
<b>7500</b>	
	<b>LATIGUILLO M8 x 3/8" x 350</b> 350 FLEXIBLE CONNECTOR M8x3/8" FLEXIBLE DE RACCORDEMENT M8x3/8" x 350 FLESSIBILE DI RACCORDO M8x3/8" x 350
<b>7501</b>	

	<b>LATIGUILLO M10 x 3/8" x 400 L75</b> 400 L75 FLEXIBLE CONNECTOR M10x3/8" FLEXIBLE DE RACCORDEMENT M10x3/8" x 400 L75 FLESSIBILE DI RACCORDO M10x3/8" 400 L75
<b>7502</b>	
	<b>PROLONGACIÓN CONEXIÓN 140 MM</b> CONNECTION EXTENSION 140 MM EXTENSION CONNEXION 140 MM ESTENSIONE CONNESSIONE 140 MM
<b>7503</b>	
	<b>LATIGUILLO M12 x 1/2" x 400</b> 400 FLEXIBLE CONNECTOR M12x1/2" FLEXIBLE DE RACCORDEMENT M12x1/2" x 400 FLESSIBILE DI RACCORDO M12x1/2" 400
<b>7506</b>	
	<b>LATIGUILLO M10 x 3/8" x 400</b> 400 FLEXIBLE CONNECTOR M10x3/8" FLEXIBLE DE RACCORDEMENT M10x3/8" x 400 FLESSIBILE DI RACCORDO M10x3/8" 400
<b>7507</b>	
	<b>PROLONGACIÓN CONEXIONES 110 MM</b> CONNECTION EXTENSION 110 MM EXTENSION CONNEXIONS 110 ESTENSIONE CONNESSIONI 110 MM
<b>7508</b>	
	<b>LATIGUILLO M10 x 3/8" x 450</b> 450 FLEXIBLE CONNECTOR M10x3/8" FLEXIBLE DE RACCORDEMENT M10x3/8" x 450 FLESSIBILE DI RACCORDO M10x3/8" 450
<b>7509</b>	
	<b>CONJUNTO FIJACIÓN M6</b> M6 FIXING KIT KIT DE FIXATION M6 KIT DI FISSAGGIO M6
<b>8000</b>	
	<b>CONJUNTO FIJACIÓN M8</b> M8 FIXING KIT KIT DE FIXATION M8 KIT DI FISSAGGIO M8
<b>8001</b>	
	<b>CONJUNTO FIJACIÓN M32</b> M32 FIXING KIT KIT DE FIXATION M32 KIT DI FISSAGGIO M32
<b>8002</b>	
	<b>CONJUNTO FIJACIÓN EXTRAIBLE</b> PULL-OUT FIXING KIT KIT DE FIXATION EXTRAIBLE KIT DI FISSAGGIO RIMOVIBILE
<b>8003</b>	
	<b>CONTRAPESO</b> COUNTERWEIGHT CONTREPOIDS CONTRAPPESO
<b>8004</b>	



**TRIÁNGULO**  
TRIANGLE  
TRIANGLE  
TRIANGOLO

8005



**FLEJO 1,2m REFORZADO PARA BIDÉ NEGRO**  
1,2m BIDET REINFORCED FLEXIBLE HOSE BLACK  
FLEXIBLE BIDET RENFORCÉ 1,2m NOIRE  
FLESSIBILE BIDET RINFORZATO 1,2m NERO

8506NG



**CAÑO DE GOMA WOLOBBY GRIS**  
RUBBER SPOUT WOLOBBY GRAY  
BEC CAOUTCHOUC WOLOBBY GRIS  
COLLO DI CIGNO IN GOMMA WOLOBBY GRIGIO

9504



**EXCÉNTRICA**  
S-COUPLING  
ECCENTRIQUE  
ECCENTRICA

8006



**FLEJO 1,2m FREG. EXTRAIBLE**  
1,2m PULL-OUT FLEXIBLE HOSE  
FLEXIBLE EXTRACTION 1,2m  
FLESSIBILE RIMOVIBILE 1,2m

8507



**CAÑO DE GOMA WOLOBBY NEGRO**  
RUBBER SPOUT WOLOBBY BLACK  
BEC CAOUTCHOUC WOLOBBY NOIRE  
COLLO DI CIGNO IN GOMMA WOLOBBY NERO

9506



**CONJUNTO FIJACIÓN M32xM37 INOX OSMOSIS**  
OSMOSIS SS M32xM37 FIXING KIT  
KIT DE FIXATION M32xM37 INOX OSMOSE  
KIT DI FISSAGGIO M32xM37 OSMOSI

8007



**CASCADA NOIR (MM-TERM)**  
NOIR WATERFALL  
CASCADE NOIRE (MITIGEUR THERMOSTATIQUE)  
CASCATA NOIR (MISCELATORE TERMOSTATICO)

8511



**CAÑO DE GOMA WOLOBBY BLANCO**  
RUBBER SPOUT WOLOBBY WHITE  
BEC CAOUTCHOUC WOLOBBY BLANC  
COLLO DI CIGNO IN GOMMA WOLOBBY BIANCO

9505



**CONJUNTO FIJACIÓN M42xM32**  
M42xM32 FIXING KIT  
KIT DE FIXATION M42xM32  
KIT DI FISSAGGIO M42xM32

8008



**ROCIADOR NOIR**  
NOIR SHOWER HEAD  
DOUCHE DE TÊTE NOIR  
SOFFIONE NOIR

8512



**CASCADA RIO-EDNA**  
RIO-EDNA WATERFALL  
CASCADE RIO-EDNA  
CASCATA RIO-EDNA

8500



**DUCHA FREG. EXTRAIBLE LOFT**  
LOFT PULL-OUT SPRAY  
DOUCHE ÉVIER. EXTRACTION LOFT  
DOCCIA LAVELLO RIMOVIBILE LOFT

8701



**JET LATERAL RIO-EDNA**  
RIO-EDNA SIDE JET  
JET LATÉRAL RIO-EDNA  
GETTO LATERALE RIO-EDNA

8501



**DUCHA FREG. EXTRAIBLE INOX**  
S.S. PULL-OUT SPRAY  
DOUCHE ÉVIER. EXTRACTION INOX  
DOCCIA LAVELLO RIMOVIBILE INOX

8702



**JET LATERAL ONNA**  
ONNA SIDE JET  
JET LATÉRAL ONNA  
GETTO LATERALE ONNA

8502



**DUCHA FREG. EXTRAIBLE**  
PULL-OUT SPRAY  
DOUCHE ÉVIER EXTRACTION  
DOCCIA LAVELLO RIMOVIBILE

8703



**FLEJO CORTO INOX. 0,7 m**  
SHORT S.S. FLEXIBLE HOSE 0,7m  
FLEXIBLE COURT INOX. 0,7 m  
FLESSIBILE CORTO INOX 0,7m

8503



**DUCHA FREG. EXTRAIBLE SORT**  
SORT PULL-OUT SPRAY  
DOUCHE ÉVIER EXTRACTION SORT  
DOCCIA LAVELLO RIMOVIBILE SORT

8704



**FLEJO CORTO PVC PLATEADO 0,7 m**  
SHORT SILVER FLEXIBLE HOSE 0,7m  
FLEXIBLE COURT PVC ARGENTÉ 0,7 m  
FLESSIBILE CORTO ARGENTATO 0,7m

8504



**DUCHA FREG. EXTRAIBLE SORT NEGRO**  
BLACK SORT PULL-OUT SPRAY  
DOUCHE ÉVIER EXTRACTION SORT NERO  
DOCCIA LAVELLO RIMOVIBILE SORT NOIRE

8704NG



**FLEJO 1,2m NYLON CONEX. RÁPIDA**  
1,2m FLEXIBLE HOSE FAST CONNECTOR  
FLEXIBLE NYLON RACCORDEMENT RAPIDE 1,2m  
FLESSIBILE NYLON RACCORDO RAPIDO 1,2m

8505



**CAÑO TUBO HOMERO**  
HOMERO TUBE SPOUT  
COL DE CYGNE HOMERO  
COLLO DI CIGNO HOMERO

9500



**FLEJO 1,2m REFORZADO PARA BIDÉ**  
1,2m BIDET REINFORCED FLEXIBLE HOSE  
FLEXIBLE BIDET RENFORCÉ 1,2m  
FLESSIBILE BIDET RINFORZATO 1,2m

8506



**CAÑO TIMES**  
TIMES SPOUT  
COL DE CYGNE TIMES  
COLLO DI CIGNO TIMES

9501



**PUNTO DE VENTA**  
**POINT OF SALE**  
**POINT DE VENTE**  
**PUNTO DI VENDITA**

EXPOSITOR DE SOBREMESA PARA GRIFERÍA / DESKTOP DISPLAY FOR FAUCETS  
PRÉSENTOIR DE COMPTOIR POUR ROBINETTERIE / ESPOSITORE DA BANCO PER RUBINETTERIA



Expositor para monomando de lavabo \*  
Display for single lever basin faucet \*  
Présentoir pour mitigeur de lavabo \*  
Espositore per miscelatore per lavabo \*  
**7 x 2 x 18 cm**

901002

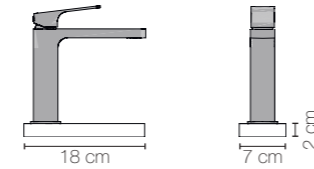

Expositor para grifería de baño \*  
Display for bathroom faucets \*  
Présentoir pour robinets de salle de bain \*  
Espositore per rubinetti da bagno \*  
**36 x 2 x 14 cm**

901001

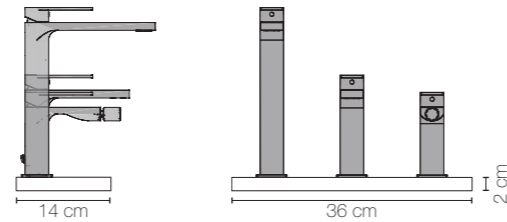

Expositor para grifería de cocina \*  
Display for kitchen faucets \*  
Présentoir pour robinets de cuisine \*  
Espositore per rubinetti da cucina \*  
**36 x 2 x 14 cm**

901001

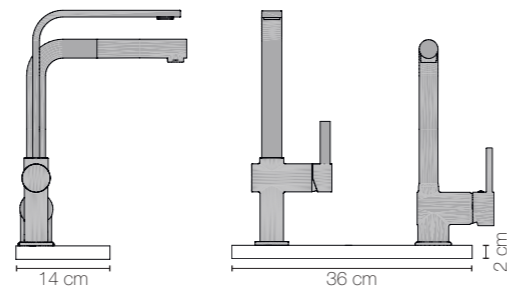

EXPOSITOR PARA CONJUNTOS HIGIÉNICOS Y KITS DE BIDET / DISPLAY FOR HYGIENIC SETS AND BIDET KITS  
PRÉSENTOIR POUR KITS HYGIÉNIQUES ET KITS DE BIDET / ESPOSITORE PER SET IGIENICI E KIT BIDET



Expositor para conjunto higiénico y kit para sustituir el bidet \*  
Display for hygienic sets and kits to replace the bidet \*  
Présentoir pour kit hygiénique et kit d'hygiène pour remplacer le bidet \*  
Présentoir pour kit hygiénique et kit pour remplacer le bidet \*  
**30 x 38 x 14 cm**

905001

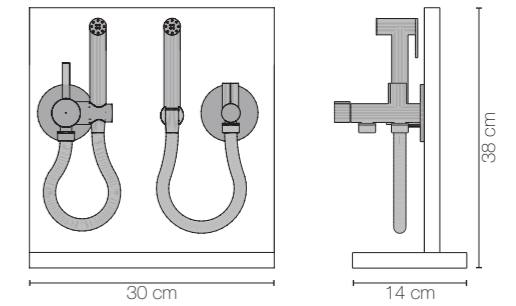

EXPOSITOR PARA PROGRAMA DE DUCHA Y ACCESORIOS / DISPLAY FOR SHOWER PROGRAMME AND ACCESSORIES  
PRÉSENTOIR POUR PROGRAMME DE DOUCHE ET ACCESSOIRES / ESPOSITORE PER PROGRAMMA DI DOCCIA E ACCESSORI



Expositor para programa de ducha y accesorios \*  
Display for shower programme and accessories \*  
Présentoir pour programme de douche et accessoires \*  
Espositore per programma di doccia e accessori \*  
**192 x 70 x 45 cm**

903001

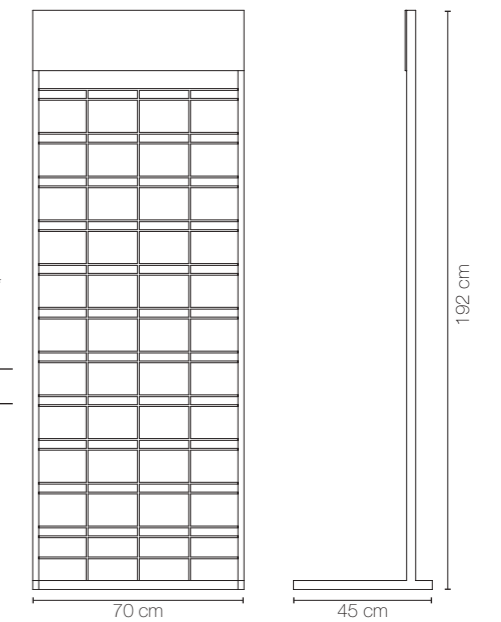

\* Se servirá con los herrajes correspondientes para su montaje. Para mas información y condiciones consulte por favor con el comercial de su zona.

\* Fittings will be provided for the assembly. For further information and conditions please contact the representative of your area

\* Livré avec les raccords correspondants pour son assemblage. Pour plus d'informations et conditions veuillez consulter le représentant de votre région.

\* Viene consegnato con i raccordi corrispondenti per il suo assemblaggio. Per ulteriori informazioni e condizioni si prega di consultare il rappresentante di vendita nella vostra zona.



EXPOSITOR PARA GRIFERÍA / DISPLAY FOR FAUCETS  
PRÉSENTOIR POUR ROBINETTERIE / ESPOSITORE PER RUBINETTERIA



Expositor para grifería de baño y cocina \*  
Display for bathroom and kitchen faucets \*  
Présentoir pour robinets de salle de bain et de cuisine \*  
Espositore per rubinetti da bagno e cucina \*  
**40 x 90 x 40 cm**

904002

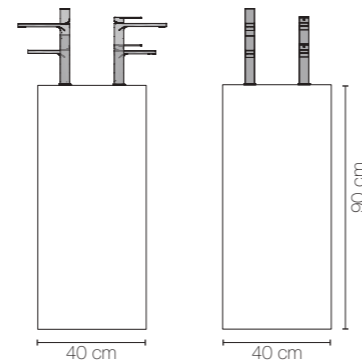

Expositor para grifería de baño y cocina  
compuesto por 2 unidades \*  
Display for bathroom and kitchen faucets  
composed by 2 units \*  
Présentoir pour robinets de salle de bain et de  
cuisine composé par 2 unités \*  
Espositore per rubinetti da bagno e cucina  
composto da 2 unità \*  
**40 x 90 x 80 cm**

904002D

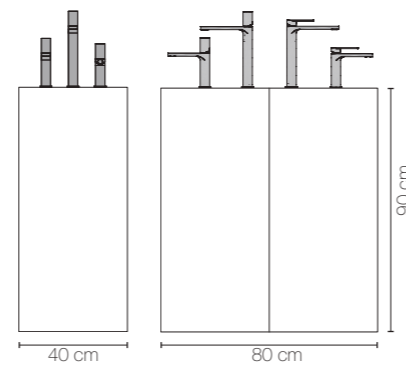

Expositor rotatorio para grifería de baño \*  
Rotative display for bathroom faucets \*  
Présentoir rotatoire pour robinets de salle de  
bain \*  
Espositore rotatorio per rubinetti da bagno \*  
**40 x 90 x 40 cm**

904001

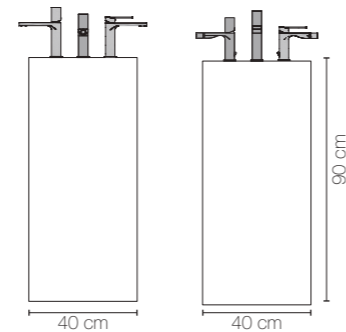

PANEL EXPOSITOR PARA PARED E ISLA / WALL-MOUNTED DISPLAY PANEL  
PRÉSENTOIR MURAL ET D'ÎLE / PANNELLO ESPOSITORE A PARETE E ISOLA

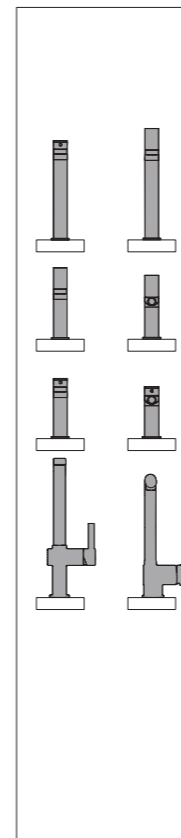

Panel expositor para grifería de baño y  
cocina \*  
Display panel for bathroom and kitchen  
faucets \*  
Présentoir pour robinets de salle de  
bain et de cuisin \*  
Pannello espositore per rubinetti da bagno e  
cucina \*  
**210 x 45 cm**

9020004

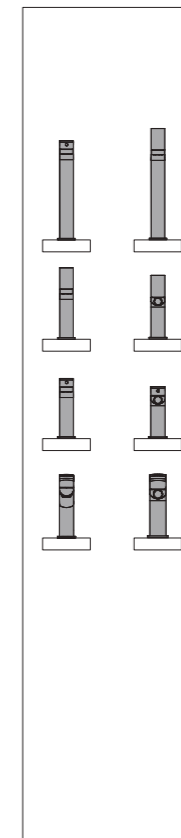

Panel expositor para grifería de baño \*  
Display panel for bathroom faucets \*  
Présentoir pour robinets de salle de bain \*  
Pannello espositore per rubinetti da bagno \*  
**210 x 45 cm**

9020004

\* Se servirá con los herrajes correspondientes para su montaje. Para mas información y condiciones consulte por favor con el comercial de su zona.

\* Fittings will be provided for the assembly. For further information and conditions please contact the representative of your area

\* Livré avec les raccords correspondants pour son assemblage. Pour plus d'informations et conditions veuillez consulter le représentant de votre région.

\* Viene consegnato con i raccordi corrispondenti per il suo assemblaggio. Per ulteriori informazioni e condizioni si prega di consultare il rappresentante di vendita nella vostra zona.

\* Se servirá con los herrajes correspondientes para su montaje. Para mas información y condiciones consulte por favor con el comercial de su zona.

\* Fittings will be provided for the assembly. For further information and conditions please contact the representative of your area

\* Livré avec les raccords correspondants pour son assemblage. Pour plus d'informations et conditions veuillez consulter le représentant de votre région.

\* Viene consegnato con i raccordi corrispondenti per il suo assemblaggio. Per ulteriori informazioni e condizioni si prega di consultare il rappresentante di vendita nella vostra zona.

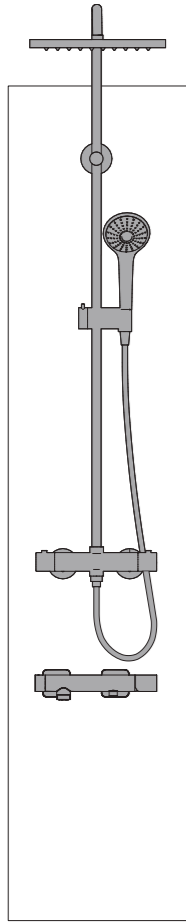

**Panel expositor para sistemas de ducha y grifería de baño \***  
Display panel for shower systems and bathroom faucets \*  
Présentoir pour systèmes de douche et robinets de salle de bain \*  
Pannello espositore per sistemi doccia e rubinetti da bagno \*  
**210 x 45 cm**

9020001



**Panel expositor para sistemas de ducha y grifería de baño \***  
Display panel for shower systems and bathroom faucets \*  
Présentoir pour systèmes de douche et robinets de salle de bain \*  
Pannello espositore per sistemi doccia e rubinetti da bagno \*  
**210 x 45 cm**

9020005

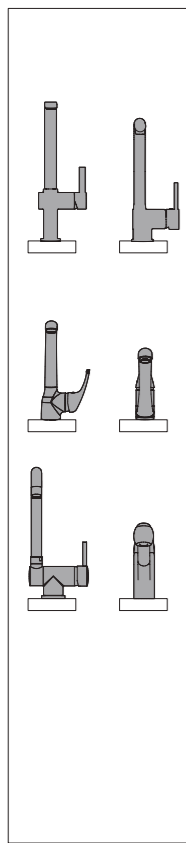

**Panel expositor para grifería de cocina \***  
Display panel for kitchen faucets \*  
Présentoir pour robinets de cuisine \*  
Pannello espositore per rubinetti da cucina \*  
**210 x 45 cm**

9020003

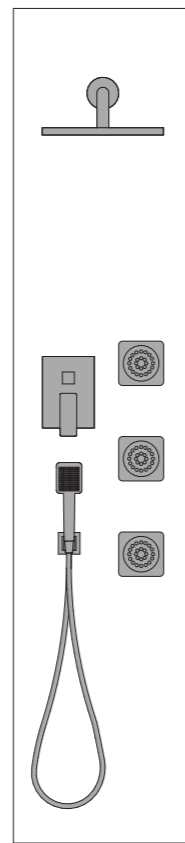

**Panel expositor para kits de empotrar \***  
Display panel for concealed sets \*  
Présentoir pour ensembles à encastrer \*  
Pannello espositore per insiemi da incasso \*  
**210 x 45 cm**

9020001

**EXPOSITOR DE PIE / PANEL DISPLAY**  
PRÉSENTOIR SUR PIED / ESPOSITORE IN PIEDI



**Expositor de pie formado por cuatro paneles. Composición a elegir \***  
Display composed by four panels. Choose your panel display composition \*  
Présentoir sur pied composé de quatre panneaux. Composition à choisir \*  
Espositore in piedi composto da quattro pannelli. Composizione da scegliere \*  
**210 x 45 x 50 cm**

9020400

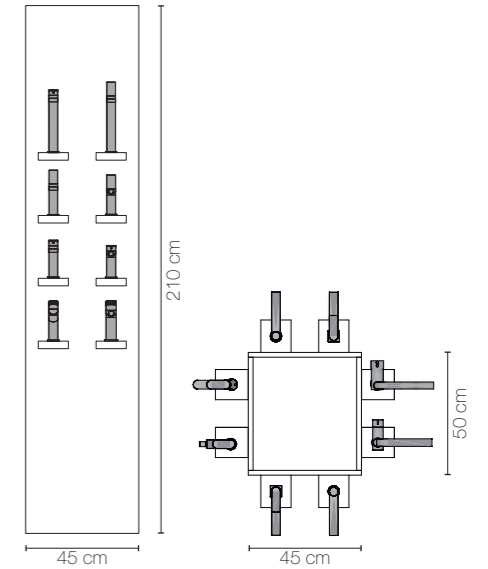

**Expositor de pie formado por tres paneles. Composición a elegir \***  
Display composed by three panels. Choose your panel display composition \*  
Présentoir sur pied composé de trois panneaux. Composition à choisir \*  
Espositore in piedi composto da tre pannelli. Composizione da scegliere \*  
**210 x 45 x 42 cm**

9020300

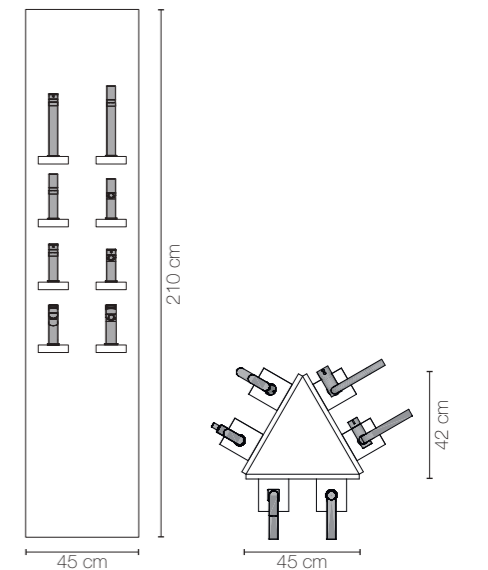

\* Se servirá con los herrajes correspondientes para su montaje. Para mas información y condiciones consulte por favor con el comercial de su zona.

\* Fittings will be provided for the assembly. For further information and conditions please contact the representative of your area

\* Livré avec les raccords correspondants pour son assemblage. Pour plus d'informations et conditions veuillez consulter le représentant de votre région.

\* Viene consegnato con i raccordi corrispondenti per il suo assemblaggio. Per ulteriori informazioni e condizioni si prega di consultare il rappresentante di vendita nella vostra zona.

\* Se servirá con los herrajes correspondientes para su montaje. Para mas información y condiciones consulte por favor con el comercial de su zona.

\* Fittings will be provided for the assembly. For further information and conditions please contact the representative of your area

\* Livré avec les raccords correspondants pour son assemblage. Pour plus d'informations et conditions veuillez consulter le représentant de votre région.

\* Viene consegnato con i raccordi corrispondenti per il suo assemblaggio. Per ulteriori informazioni e condizioni si prega di consultare il rappresentante di vendita nella vostra zona.

**Precios:**

Los precios de nuestra tarifa se consideran precios recomendados de venta al público antes de impuestos. Los precios de venta aplicados en factura serán aquellos de la tarifa vigente en el momento de la recepción del pedido.

Estos precios pueden estar sujetos a cambios por motivos de diversa consideración, en cuyo caso se notificará oportunamente.

**Diseño:**

Nuestros productos podrán ser modificados total o parcialmente, sin previo aviso, en beneficio del artículo. La documentación de este catálogo, fotografías, descripciones y esquemas técnicos, tienen un valor indicativo, por lo que el cliente no se podrá acoger a ellos en caso de disconformidad con el producto suministrado.

**Condiciones de pago:**

Las facturas serán pagadas en los plazos establecidos por la Ley 15/2010, de 5 de julio, de modificación de la Ley 3/2004, de 29 de diciembre, por la que se establecen las medidas de lucha contra la morosidad en operaciones comerciales.

**Plazos de entrega:**

Nuestros plazos de entrega son aproximados y no podrán ser objeto de ninguna reclamación.

**Expedición de mercancía:**

El destinatario deberá comprobar la mercancía a la recepción de la misma, verificando su estado e indicando en el albarán del transportista las posibles incidencias (daños, ya sea en los artículos o en el embalaje de los mismos a causa del transporte, así como discrepancias en el número de bultos, etc.). El cliente deberá informar en un plazo máximo de 24 horas, límite máximo fijado por las agencias para la comunicación de incidencias, enviando correo electrónico adjuntando la información y el material gráfico pertinente. En caso contrario nuestra empresa no se podrá hacer cargo de ninguna reclamación al respecto.

**Garantía AQUAGRIF, S.L.**

Todos nuestros productos están garantizados, ante eventuales defectos de fabricación, durante un período de 3 años, con las siguientes excepciones que disfrutan de una garantía ampliada:

- Grifería de baño y cocina cromadas: 5 años (a excepción de la grifería electrónica que son 3 años)
- Grifería termostática: 5 años
- Productos con sello AISI 304: 5 años



Para ejercer los derechos que ofrece esta garantía será imprescindible por parte del cliente, la presentación del comprobante de compra emitido al usuario final en la fecha de venta del producto. Nuestra responsabilidad se limitará a la reparación o sustitución total o parcial del artículo (una vez analizado y aceptado el defecto por nuestro departamento de calidad) y en ningún caso cubre gastos adicionales (gastos ocasionados por los trabajos de reparación, instalación, ...).

Quedan excluidos de esta garantía los daños producidos por los productos de limpieza, el uso inadecuado, montaje incorrecto, desgaste natural, mantenimiento inadecuado, así como los producidos por impurezas del agua (acumulación de suciedad, cal, ...).

La eventual reparación o sustitución de componentes del producto afectado no extiende la ampliación de la Garantía. En caso de que en el momento de la aplicación de la garantía el producto ya no se fabrique, se suministrará un producto similar de igual calidad.

**Devoluciones:**

1. No se aceptarán devoluciones de mercancía sin que estas hayan sido previamente autorizadas por parte de nuestro departamento comercial. En caso de no estar autorizadas, la mercancía será devuelta al remitente.
2. No se admitirá ninguna devolución de mercancía que esté fuera de garantía.
3. Solo se admitirán devoluciones de materiales que presenten defectos imputables al proceso de fabricación y que no se puedan solucionar con recambios originales de AQQ.
4. En el caso de aceptación y posterior recepción de mercancía, esta deberá estar adecuadamente encajada y sufrirá una depreciación en factura de:
  - 10% si es de hace menos de un año
  - 25% en el caso de más de un año
  - 40% en el caso de más de dos años

No se aceptará ninguna devolución que no se ajuste a las especificaciones descritas anteriormente.

**Cambios:**

Los cambios deberán ser autorizados previamente por nuestro departamento comercial. Todo el material expedido por nuestra empresa, incluido el destinado a cambios, será remitido con cargo en factura sin perjuicio de la emisión del correspondiente abono a la recepción por nuestra parte de la mercancía objeto de cambio.

**Aceptación de condiciones:**

Todo pedido recibido, implica la aceptación de estas condiciones, salvo en el caso de que se hayan pactado otras por escrito.

**Propiedad intelectual:**

Todas las imágenes e ilustraciones contenidas en este catálogo son propiedad de Aquagrif, s.l. o de sus respectivos propietarios. No se permite el uso de las mismas a terceras personas sin la autorización expresa de nuestra empresa o de los respectivos propietarios de los contenidos.

**Prices:**

The prices of our price list are retail prices before taxes. The retail prices applied in the invoice will be those that appear in the price list in force in the moment of the reception of the order.

These prices may be subject to modification because of changes of different consideration, in which case will be notified in due course.

**Design:**

Our products could be modified because of design requirements, without notice, for the benefit of the product. The documentation of this catalogue, photographic, technical drawings, have an indicative value, consequently, the customer will not be able to present it as disconformity with the product supplied.

**Payment conditions:**

The invoices will be paid in the deadlines established in Law 15/2010, 5th July, modification of Law 3/2004, 29th December, where the measures against default in the commercial transactions are established.

**Delivery terms:**

Our delivery terms are approximate and will not be subject to any claim.

**Dispatching goods:**

The consignee will have to verify the merchandise when receiving the goods, check the status and indicate in the transport document the possible incidents (damages in the products or in the packaging due to the transport, discrepancies in the number of boxes, etc.). The client must inform within 24 hours, maximum allowable by the transport agency for the communication of incidents, sending an email enclosing the information as well as the appropriate graphic material. Otherwise, our company will not be in charge of any reclamation.

**Guarantee:**

All our products are guaranteed against possible defects which are attributable to the production process during a period of 3 years, with the following exceptions which have an extended guarantee:

- Bath and kitchen faucets chromed: 5 years (except electronic faucets which is 3 years)
- Thermostatic mixers: 5 years
- Products with seal AISI 304: 5 years



To exercise the right that offers this guarantee is necessary that the client presents the purchase receipt issued to the end user with the date which the product was bought. Our liability will be limited only and exclusively to substitute the defective product and in no case will cover additional expenses (costs related to repair works, installation, etc.), which will be in charge of the consumer.

**Returns:**

1. Aquagrif SL, will not accept any return of merchandise, unless it has been previously approved by our sales department. In case of not being approved, the merchandise will be returned to the sender.
2. Any return of merchandise will not be accepted if the product is out of guarantee.
3. Aquagrif SL, will only accept returns of merchandise that present defects attributable to the manufacturing process and that cannot be solved with original spare parts
4. In case of acceptance and after receiving the merchandise, this will have to be perfectly packaged and will suffer a depreciation in invoice of:
  - Less than one year: 10% depreciation
  - More than one year: 25% depreciation
  - More than two years: 40% depreciation

No returns will be accepted if they do not comply with the requirements abovementioned.

**Changes:**

All the changes must be approved by our sales department. All the merchandise issued by Aquagrif, including those with modifications, will be referred with charge on the invoice without prejudice in the issuance of the credit note once the merchandise subject to modification is received.

**Acceptance of conditions:**

All orders received means the acceptance of these conditions, unless something else has been accorded by written.

**Intellectual properties:**

All the pictures and illustrations contained in this catalogue are property of Aquagrif S.L. or of their respective owners. It is not allowed its use to third parties without the express authorization of our company or of the respective owners of the contents.

**Les prix :**

Les prix de notre tarif sont considérés comme des prix de vente recommandés au public + TVA légale éventuelle. Les prix de vente appliqués sur facture sont ceux du tarif en vigueur au moment de la réception de la commande.

Ces prix peuvent être modifiés pour des raisons diverses, Ces prix peuvent être sujets à changement pour des raisons de considération différente, auquel cas vous serez informé en temps voulu.

**Design :**

Nos produits peuvent être modifiés totalement ou partiellement, sans préavis, au bénéfice de l'article. La documentation de ce catalogue, photographies, descriptions et schémas techniques, ont une valeur indicative, de sorte que le client ne pourra pas en faire usage en cas de non-conformité avec le produit fourni.

**Conditions de paiement :**

Les factures seront payées dans les délais établis par la Loi 15/2010, du 5 juillet, de modification de la Loi 3/2004, du 29 décembre, établissant des mesures de lutte contre le retard de paiement au cours d'opérations commerciales.

**Délais de livraison :**

Nos délais de livraison sont approximatifs et ne pourront faire l'objet d'aucune réclamation.

**Expédition de marchandise :**

Le destinataire doit vérifier la marchandise à la réception de celle-ci en vérifiant son état et en indiquant sur le bon de livraison du transporteur les éventuels incidents (endommagement des articles ou de leur emballage dû au transport, ainsi que des divergences dans le nombre de colis, etc.). Le client doit faire un rapport dans un délai maximum de 24 heures, limite maximale fixée par les agences pour la communication des incidents, en envoyant un courrier électronique en joignant les informations et le matériel graphique pertinents. Dans le cas contraire, notre société ne pourra prendre en charge aucune réclamation à ce sujet.

**Garantie AQUAGRIF, S.L.**

Tous nos produits sont garantis, en cas d'éventuels défauts imputables au processus de fabrication du produit, pendant une période de 3 ans, avec les exceptions suivantes, pour lesquelles Aquagrif, S.L. s'engage à une prolongation de cette période :

- Robinetterie de bain et de cuisine chromées : 5 ans (à l'exception de la robinetterie électronique pour laquelle celle-ci est de 3 ans)
- Robinetterie thermostatique : 5 ans
- Produits avec label AISI 304 : 5 ans



Pour exercer les droits offerts par cette garantie, le client devra impérativement présenter la preuve d'achat émise à l'utilisateur final à la date de vente du produit. Notre responsabilité se limitera à la réparation ou au remplacement total ou partiel de l'article (après analyse et acceptation du défaut par notre département qualité) et ne couvrira en aucun cas des frais supplémentaires (frais occasionnés par les travaux de réparation, d'installation, ...).

Sont exclus de cette garantie les dommages causés par les produits de nettoyage, une mauvaise utilisation, assemblage incorrect, l'usure naturelle, un entretien inadéquat, ainsi que ceux produits par les impuretés de l'eau (accumulation de saleté, calcaire, ...)

La réparation ou le remplacement éventuel de composants du produit concerné ne s'étend pas à l'extension de la garantie. Si le produit n'est plus fabriqué au moment de l'application de la garantie, un produit similaire de même qualité sera fourni.

**Retours :**

1. Les retours de marchandises ne seront pas acceptés sans autorisation préalable de notre département commercial. En cas de retour non autorisés, la marchandise sera renvoyée à l'expéditeur
2. Aucun retour de marchandise hors garantie n'est admis.
3. Seuls les matériaux présentant des défauts imputables au processus de fabrication et qui ne peuvent être réparés par des pièces de rechange d'origine AQG sont autorisés.
4. En cas d'acceptation et de réception ultérieure de la marchandise, celle-ci doit être correctement emballée et subira une dépréciation sur facture de :
  - 10% si celle-ci à moins d'un an.
  - 25% si celle-ci à plus d'un an.
  - 40% si celle-ci à plus de 2 ans.

Aucun retour ne pourra être accepté s'il n'est pas conforme aux spécifications décrites ci-dessus.

**Changements :**

Les changements doivent être préalablement autorisés par notre service commercial. Tout le matériel expédié par notre société, y compris le matériel destiné à être échangé, sera envoyé avec facture, nonobstant le fait de l'émission de la note de crédit correspondant à la réception de la marchandise échangée.

**L'acceptation des conditions:**

Toute commande reçue, implique l'acceptation de ces conditions à moins qu'il n'en ait été convenu autrement par écrit.

**Propriété Intellectuelle :**

Toutes les images et illustrations contenues dans ce catalogue sont la propriété d'Aquagrif, s.l. ou de leurs propriétaires respectifs. L'utilisation de ces contenus par des tiers n'est pas autorisée sans l'autorisation expresse de notre société ou de leurs propriétaires respectifs.

**Prezzi:**

I prezzi nella nostra tariffa sono considerati prezzi al dettaglio consigliati al lordo delle tasse + eventuale IVA di legge. I prezzi di vendita applicati in fattura saranno quelli della tariffa in vigore al momento della ricezione dell'ordine.

Tali prezzi possono subire variazioni per ragioni di varia natura, nel qual caso ne sarà data tempestiva comunicazione.

**Design:**

I nostri prodotti possono essere totalmente o parzialmente modificati, senza preavviso, a beneficio dell'articolo. La documentazione contenuta in questo catalogo, fotografie, descrizioni e schemi tecnici, hanno valore indicativo, pertanto il cliente non potrà accettarli in caso di disaccordo con il prodotto fornito.

**Condizioni di pagamento:**

Le fatture saranno pagate nei termini stabiliti dalla Legge 15/2010, del 5 luglio, modificando la Legge 3/2004, del 29 dicembre, che stabilisce le misure di contrasto ai ritardi di pagamento nelle operazioni commerciali.

**Tempi di consegna:**

I nostri tempi di consegna sono approssimativi e non possono essere oggetto di alcun reclamo.

**Spedizione della merce:**

Il destinatario è tenuto a controllare la merce al ricevimento, verificandone lo stato e segnalando sulla bolla di consegna del vettore eventuali inconvenienti (danni, dovuti al trasporto, agli articoli o al loro imballo, nonché difformità nel numero dei colli, ecc.). Il cliente è tenuto a segnalare, entro un termine massimo di 24 ore, il limite massimo fissato dalle agenzie per la comunicazione degli incidenti, inviando una mail allegando le informazioni e il relativo materiale grafico. In caso contrario, la nostra azienda non potrà farsi carico di alcun reclamo al riguardo.

**Garanzia AQUAGRIF, S.L.**

Tutti i nostri prodotti sono garantiti, contro eventuali difetti di fabbricazione, per un periodo di 3 anni, con le seguenti eccezioni che godono di una garanzia estesa:

- Rubinetti cromati per bagno e cucina: 5 anni (tranne i rubinetti elettronici, che sono 3 anni)
- Rubinetto termostatico: 5 anni
- Prodotti con guarnizione in AISI 304: 5 anni



Per esercitare i diritti offerti dalla presente garanzia, sarà indispensabile che il cliente presenti la prova d'acquisto rilasciata all'utente finale alla data di vendita del prodotto. La nostra responsabilità sarà limitata alla riparazione o sostituzione totale o parziale dell'articolo (una volta che il difetto è stato analizzato e accettato dal nostro ufficio qualità) e in nessun caso copre le spese aggiuntive (spese causate da lavori di riparazione, installazione, ...)

Sono esclusi da questa garanzia i danni causati da prodotti per la pulizia, uso improprio, montaggio errato, usura naturale, manutenzione inadeguata, nonché quelli causati da impurità nell'acqua (accumulo di sporco, calcare, ...)

L'eventuale riparazione o sostituzione di componenti del prodotto interessato non estende l'estensione della Garanzia. Nel caso in cui al momento dell'applicazione della garanzia il prodotto non sia più fabbricato, verrà fornito un prodotto simile di pari qualità.

**Resi:**

1. Non saranno accettati resi di merce senza previa autorizzazione del nostro ufficio commerciale. In caso di mancata autorizzazione, la merce verrà rispedita al mittente
2. Non saranno accettati resi di merce fuori garanzia.
3. Saranno accettati esclusivamente resi di materiali che presentino difetti imputabili al processo produttivo e che non siano risolvibili con ricambi originali AQG.
4. In caso di accettazione e successivo ricevimento della merce, questa dovrà essere adeguatamente imballata e subirà un deprezzamento in fattura di:
  - a. 10% se ha meno di un anno
  - B. 25% in caso di più di un anno
  - C. 40% in caso di più di due anni

Qualsiasi reso non conforme alle specifiche sopra descritte non sarà accettato.

**I cambiamenti:**

Le modifiche devono essere preventivamente autorizzate dal nostro ufficio commerciale. Tutto il materiale emesso dalla nostra azienda, compreso quello destinato al cambio, verrà spedito con addebito in fattura, fermo restando l'emissione del relativo pagamento al ricevimento da parte nostra della merce oggetto di cambio.

**Accettazione delle condizioni:**

Qualsiasi ordine ricevuto implica l'accettazione delle presenti condizioni, salvo diverso accordo scritto.

**Proprietà intellettuale:**

Tutte le immagini e le illustrazioni contenute in questo catalogo sono di proprietà di Aquagrif, s.l. o i rispettivi proprietari. L'utilizzo degli stessi da parte di terzi non è consentito senza l'espressa autorizzazione della nostra società o dei rispettivi proprietari dei contenuti.



