

MINIMA  
MINIMA PLUS  
MEDIA  
MASSIMA  
SURFACE METALLI  
NICCHIE E BOTOLE  
ARMADI  
BATTISCOPA

5



---

SISTEMI FILOMURO



MINIMA  
DOUBLÉ  
BIDIREZIONALE  
PLUS  
MEDIA  
MASSIMA  
CRYSTAL  
CRYSTAL BI  
ALASKA  
BATTISCOPA  
NICCHIE / BOTOLE / ARMADI

---

SEZIONE TECNICA / TECHNICAL DETAILS	204
FINITURE / FINISHES	222
MANIGLIE / HANDLES	230
ACCESSORI / ACCESSORIES	238
CERTIFICAZIONI / CERTIFICATIONS	244

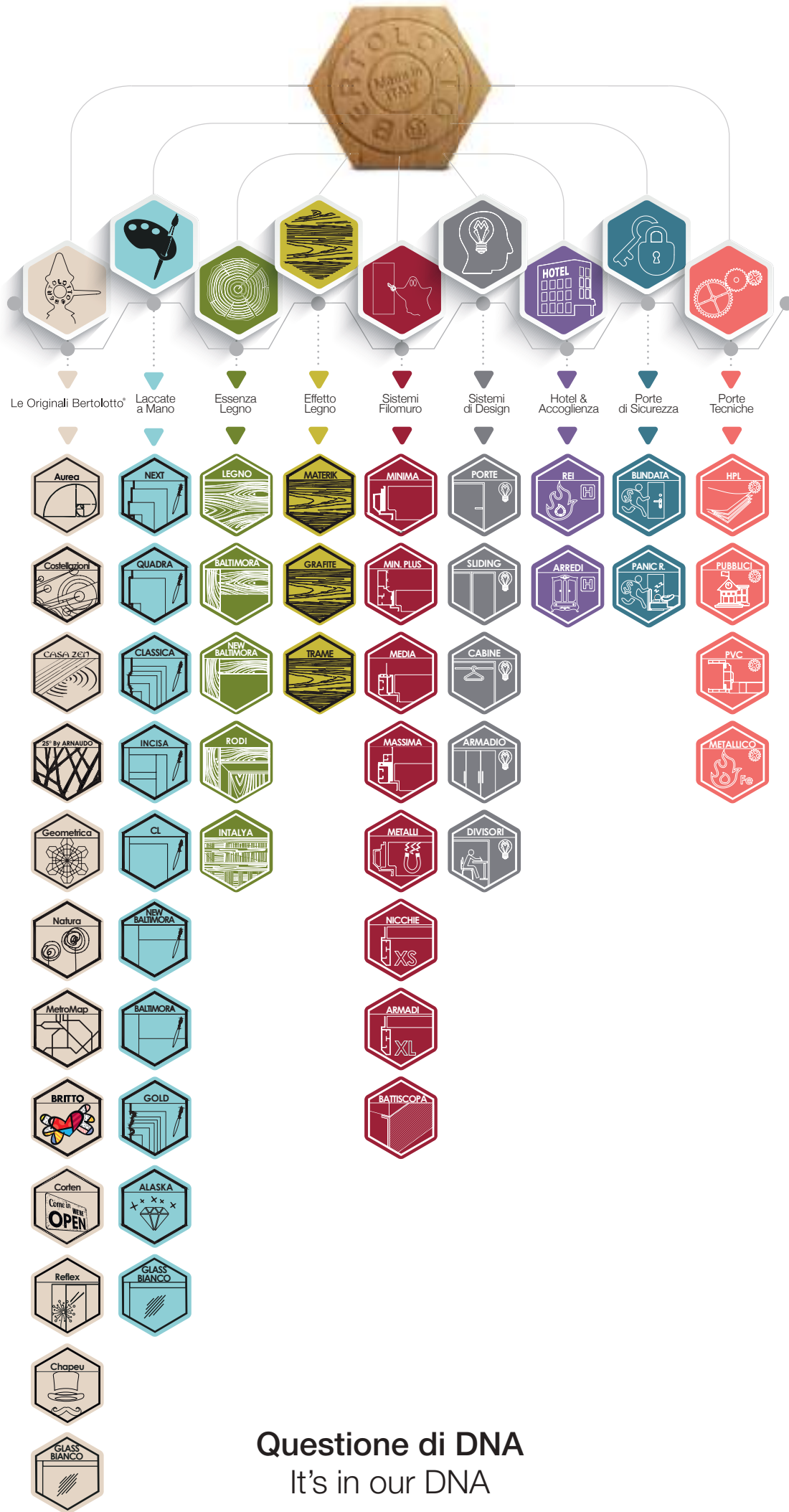

**Questione di DNA**  
It's in our DNA

## 1 Le Originali Bertolotto®

- |   |                           |                 |
|---|---------------------------|-----------------|
| 1 Aurea, Slim e Bold                        | 5 Geometrica              | 10 Reflex       |
| 2 Costellazioni                             | 6 Natura                  | 11 Chapeau      |
| 3 Casa Zen                                  | 7 MetroMap                | 12 Glass Bianco |
| 4 25° By ARNAUDO:<br>Boulevard, Avenue, Mag | 8 Britto Loves Bertolotto |                 |
|   | 9 Corten                  |                 |

## 2 Laccate a Mano

- |                 |                         |
|-----------------|-------------------------|
| 1 PantoNext     | 6 Glass Bianco          |
| 2 PantoQuadra   | 7 Laccate Baltimora New |
| 3 PantoClassica | 8 Laccate Baltimora     |
| 4 Pantolncisa   | 9 Laccate Gold          |
| 5 CL            | 10 Vetri Alaska         |

## 3 Essenza Legno

- |   |                                 |
|---|---------------------------------|
| 1 Tranciato: CL, Doga, Doga Hori,<br>N2, N4, S3, S5 | 3 Legno Baltimora New           |
| 2 Legno Baltimora                                   | 4 Massello Rodi: Antikè, Electa |
|   | 5 Intalya                       |

## 4 Effetto Legno

- 1 **Materik**, Materik Vetro
- 2 **Grafite**, Grafite Profilo, Grafite Glass
- 3 **Trame**, Trame Profilo

## 5 Sistemi Filomuro

- |               |                    |
|---------------|--------------------|
| 1 Minima      | 5 Surface Metalli  |
| 2 Minima Plus | 6 Nicchie e Botole |
| 3 Media       | 7 Armadi           |
| 4 Massima     | 8 Battiscopa       |

## 6 Sistemi di Design

- 1 Porte
- 2 Sistemi Scorrevoli
- 3 Cabine Armadio
- 4 Armadi
- 5 Pareti Divisorie

## 7 Hotel & Accoglienza

- 1 Porte Tagliafuoco
- 2 Arredi

## 8 Porte di Sicurezza

- 1 Porte Blindate
- 2 Panic Room

## 9 Porte Tecniche

- 1 Porte Laminato HPL
- 2 Porte Enti Pubblici
- 3 Porte PVC
- 4 Tagliafuoco Metallico



<b>ALBERI SALVATI</b>	<b>8.470</b>
<b>AREA VERDE</b>	<b>31,40 ETTARI</b>
<b>RECUPERO CO<sub>2</sub></b>	<b>507,27 t</b>
<b>LEGNAME</b>	<b>11.550 M<sup>3</sup></b>

*“Credo che avere la terra e non rovinarla sia la più bella forma d’arte che si possa desiderare.”  
 “I think having land and not ruining it is the most beautiful art that anybody could ever want.”*

ANDY WARHOL



Bertolotto Green si pone come obiettivo quello di minimizzare l’impatto ambientale, nella consapevolezza che se non si preserva la nostra amata terra non preserveremo noi stessi. Seguendo questa filosofia, l’azienda ha voluto ottenere per i suoi materiali i certificati FSC® - Carb Epa - VOC. I processi produttivi sono autoalimentanti con energia elettrica e termica, attraverso innovativi impianti fotovoltaici e una centrale a biomassa. Nell’arco di un anno, mediamente Bertolotto salva 8.470 alberi che corrispondono ad un’area di 31,40 ettari di terreno - e recupera 507,27 tonnellate di CO<sub>2</sub>. Da questo impegno derivano prodotti da noi utilizzati per produrre le nostre porte - MDF, LSB, Listellare, Legname per un totale di circa 11.550 metri cubi di materia prima. Numeri così significativi esprimono concretamente la nostra filosofia green. Lavorare in modo responsabile è un impegno costante e imprescindibile per noi, la qualità del prodotto finito è fatta anche di rispetto e tutela dell’ambiente e ci piace pensare che contribuiamo a mantenere verde la terra e pulite acqua e aria. Ci piace anche pensare che in ognuna delle nostre porte sia custodito un pezzetto del mondo di cui ci prendiamo cura, e che questo piccolo pezzo di mondo si sia trasformato in un oggetto di design che ci accoglie e ci protegge ogni giorno nell’ambiente più caro a ciascuno: la casa. Così, nella nostra quotidianità un pezzo di albero diventa parte della storia delle nostre vite, mentre una nuova pianta cresce per far parte della vita di tutti e di domani. / Mindful that if we don’t work to save our planet we cannot save ourselves, Bertolotto Green aims to minimize its environmental impact. This philosophy has led the company to obtain FSC® - Carb Epa - VOC certification for its materials. Moreover our manufacturing processes are powered by electrical and thermal energy produced by our own photovoltaic system and a biomass thermal power plant. On average, over a one year period, Bertolotto saves 8.470 trees, which corresponds to an area of 31.40 hectares of terrain, and recovers 507.27 tonnes of CO<sub>2</sub>. The products we use to make our doors are the result of this commitment - MDF, LSB, slats and timber for a total of about 11,550 cubic meters of raw material. Such significant numbers are a true expression of our green philosophy. Working in a responsible way is both an essential and constant commitment for us. Respecting and safeguarding the environment contributes to the quality of the finished product and we like to think that we play our part in keeping the earth green and the air and water clean. We also like to think that a part of the world we are caring for can be found in each of our doors, and that this little part is transformed into a design object that welcomes us and protects us in the place we most care about: our home. So part of a tree, transformed into an everyday object, becomes part of the story of our lives, while a new plant grows to become part of everyone’s lives and of the future.



Il sigillo Bertolotto è il nostro marchio che garantisce l'autenticità di un prodotto Made in Italy da filiera certificata di elevata qualità, supportato da 96 brevetti internazionali depositati, oltre a centinaia di certificati di prodotto. / The Bertolotto seal is our Trademark, it guarantees the authenticity of a Made in Italy product, ensuring high quality manufacturing processes, supported by 96 international deposited patents and hundreds of product certifications.



## COLLEZIONE FILOMURO

La collezione Filomuro di Bertolotto Porte è declinata in diversi modelli, tipologie e sistemi d'apertura: battente, scorrevole interno muro, Doublé, Bidirezionale. Filomuro propone le soluzioni ideali per la casa contemporanea. / The Filomuro collection comes in a range of different models, types and opening systems: hinged, pocket, Doublé and Bidirezionale. Filomuro provides ideal solutions for contemporary homes.





Le Originali Bertolotto®

COSTELLAZIONI  
ANDROMEDA

Apertura / Opening  
Battente / Hinged

Tipologia / Typology  
Minima

Finitura / Finish  
Laccato opaco Avorio /  
Avorio matt lacquered

Maniglia / Handle  
Dada









Le Originali Bertolotto®

COSTELLAZIONI  
AURIGA

Apertura / Opening  
Battente / Hinged

Tipologia / Typology  
Minima

Finitura / Finish  
Laccato opaco RAL /  
RAL matt lacquered

Maniglia / Handle  
Must

Le Originali Bertolotto®

ALASKA 3153

Apertura / Opening  
Battente / Hinged

Tipologia / Typology  
Minima Alaska

Vetro / Glass  
Satinato Grigio Inciso

Maniglia / Handle  
Must

BATTISCOPIA  
FILOMURO PRIMER

## COSTELLAZIONI

La collezione Costellazioni propone motivi geometrici ispirati alle orbite celesti. Una caratterizzazione originale di segni grafici incisi sulle porte, che vengono successivamente laccate in finitura opaca. / The Costellazioni collection has geometric patterns inspired by the night sky. An original feature with designs engraved directly on the door which is subsequently lacquered with opaque or gloss finishes.











Le Originali Bertolotto®

---

COSTELLAZIONI  
VEGA

---

Apertura / Opening  
Doppio battente /  
Double hinged

---

Tipologia / Typology  
Media

---

Finitura / Finish  
Laccato opaco Bianco /  
Bianco matt lacquered

---

Maniglione / Handle  
Linear

---

Le Originali Bertolotto®

---

COSTELLAZIONI  
VEGA

---

Tipologia / Typology  
Boiserie a parete /  
Wall panelling

---

Finitura / Finish  
Laccato opaco Bianco  
/ Bianco matt  
lacquered

## COSTELLAZIONI: BOISERIE COORDINATE

Il motivo Costellazioni inciso sui pannelli che compongono le boiserie valorizza la parete, un perfetto coordinamento di finiture tra le soluzioni creative di porte e pareti. / The Costellazioni pattern engraved on panelling enhances the wall giving you perfectly coordinated finishes from our creative solutions for doors and walls.

Costellazioni: matching panelling

FILOMURO MEDIA DOPPIA A SPINGERE /  
DOUBLE HINGED PUSH VERSION

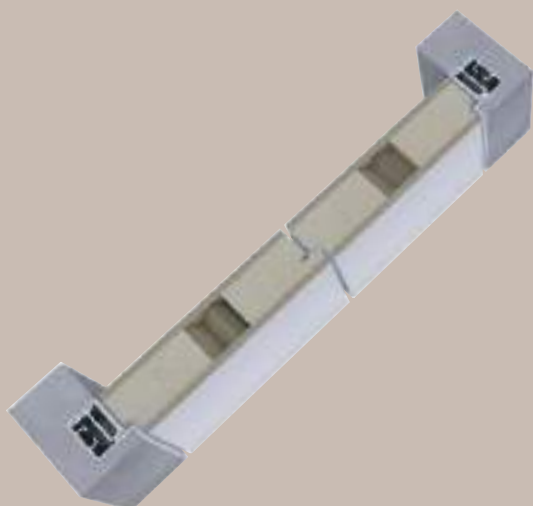







Le Originali Bertolotto®

COSTELLAZIONI  
ALTAIR

Apertura / Opening  
Battente / Hinged

Tipologia / Typology  
Plus

Finitura / Finish  
Laccato opaco Bianco /  
Bianco matt lacquered

Maniglia / Handle  
Bilbao

FILOMURO PLUS PER MURATURA / MASONRY

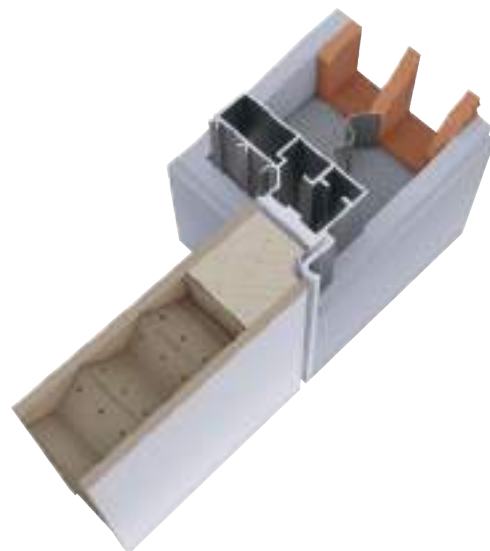

## DESIGN ESCLUSIVO

Un decoro originale e dal design esclusivo. La geometria del disegno alterna linee rette e curve ispirate alle orbite celesti, un segno distintivo in grado di valorizzare qualsiasi ambiente contemporaneo. / An exclusively designed original decoration. The geometry of the pattern alternates straight and curved lines inspired by the night sky, a distinctive design that adds value to any contemporary environment.

Exclusive design





Le Originali Bertolotto®

COSTELLAZIONI  
AURIGA

Apertura / Opening  
Scorrevole  
a scomparsa /  
Pocket door

Finitura / Finish  
Laccato opaco Rosso  
Rosso matt lacquered

Maniglia / Handle  
Unghiata Kuader

Le Originali Bertolotto®

COSTELLAZIONI  
AURIGA

Apertura / Opening  
Battente / Hinged

Tipologia / Typology  
Minima

Vetro / Glass  
Laccato opaco Rosso  
Rosso matt lacquered

Maniglia / Handle  
Bilbao

BATTISCOPIA  
FILOMURO PRIMER









Le Originali Bertolotto®

---

AVENUE

---

Apertura / Opening  
Battente / Hinged

---

Tipologia / Typology  
Plus

---

Finitura / Finish  
Laccato opaco Avorio /  
Avorio matt lacquered

---

Maniglia / Handle  
Bilbao

---

Sistemi di Design

---

CRYSTAL 3258  
Boulevard

---

Apertura / Opening  
Battente / Hinged

---

Tipologia / Typology  
Minima Crystal

---

Profilo / Frame  
Argento

---

Vetro / Glass  
Trasparente sabbiato

---

Maniglia / Handle  
Bilbao

---

## AVENUE

Da un'idea dell'architetto e designer Gianni Arnaudo prende forma la collezione Avenue ispirata ai viali alberati, realizzata con incisioni dal tratto deciso e netto. / From an idea by the architect and designer Gianni Arnaudo the Avenue collection took shape. It was inspired by tree lined avenues and created using clear and decisive engravings.

FILOMURO PLUS PER MURATURA / MASONRY

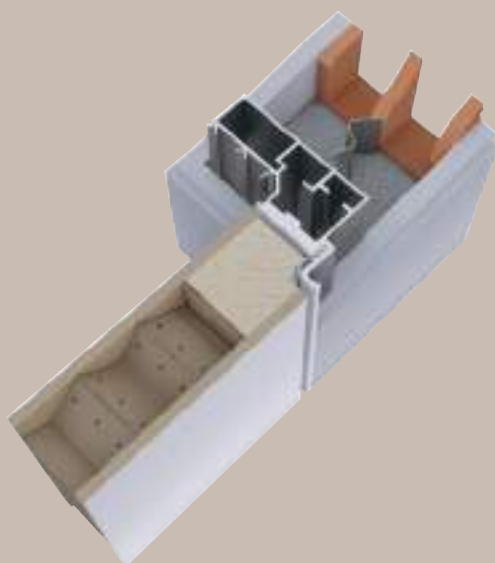

Le preziose incisioni di Avenue valorizzano le porte per un progetto d'interior di grande fascino espressivo. Design lineare e stile per una porta dalla personalità distintiva. / The precious Avenue engravings enhance the doors, adding real interest to an interior design project. Linear designs and style for a door with a distinctive personality.









Le Originali Bertolotto®

AVENUE

Apertura / Opening  
Battente / Hinged

Tipologia / Typology  
Plus

Telaio / Frame  
Laccato opaco Bianco /  
Bianco matt lacquered

Maniglia / Handle  
Bilbao

FILOMURO PLUS PER CARTONGESSO / DRYWALL



Laccate a Mano

PANTOINCISA  
BP 1036

Apertura / Opening  
Battente / Hinged

Tipologia / Typology  
Plus

Finitura / Finish  
Laccato opaco Bianco /  
Bianco matt lacquered

Maniglia / Handle  
Bilbao





## PANTOINCISA FILOMURO

Eleganti tratti orizzontali valorizzano il disegno delle porte Pantolncise Filomuro che il gioco di superfici in bassorilievo rimarca. / Elegant horizontal engravings appreciate the design of the Filomuro Pantolncise doors, which is enhanced by the play in bas-relief on the surfaces.

Filomuro engraved



Laccate a Mano

---

CL

Apertura / Opening

Double

Finitura / Finish

Laccato lucido colore RAL /  
RAL colour gloss lacquered

Maniglia / Handle

Bilbao

Laccate a Mano

---

CL

Apertura / Opening

Battente / Hinged

Tipologia / Typology

Plus

Finitura / Finish

Laccato lucido colore RAL /  
RAL colour gloss lacquered

Maniglia / Handle

Bilbao





## CL FILOMURO

La collezione Filomuro propone il modello CL, elegante ed essenziale, in cui le finiture di grande pregio come il laccato lucido, proposto anche come colore al campione RAL, rappresentano scelte di forte personalità. / The collection includes the elegant and minimalist CL model, with its high quality finishes, such as the gloss lacquer also available in colours from the RAL chart, it provides a choice with real personality.









Laccate a Mano

---

CL

Apertura / Opening  
Battente / Hinged

---

Tipologia / Typology  
Media

---

Finitura / Finitura  
Laccato lucido colore  
RAL / RAL colour  
gloss lacquered

---

Maniglia / Handle  
Bilbao

---

Laccate a Mano

---

ALASKA 3409

Apertura / Opening  
Battente / Hinged

---

Tipologia / Typology  
Minima Alaska

---

Vetro / Glass  
Satinato sabbaiato  
con Acquerelli

---

Maniglia / Handle  
Bilbao

## ALASKA FILOMURO

Alaska è una collezione di porte in vetro dal design rigoroso ed essenziale. Sono proposti vetri trasparenti, satinati, Stop-sol, Materik e decorati con motivi sabbiati o incisi. / Alaska is a collection of glass doors with a precise, minimalist design. Available with the following glass: transparent, opaque, Stop-sol, Materik and decorated with sandblasted or engraved patterns.

---

FILOMURO MINIMA ALASKA PER MURATURA / MASONRY

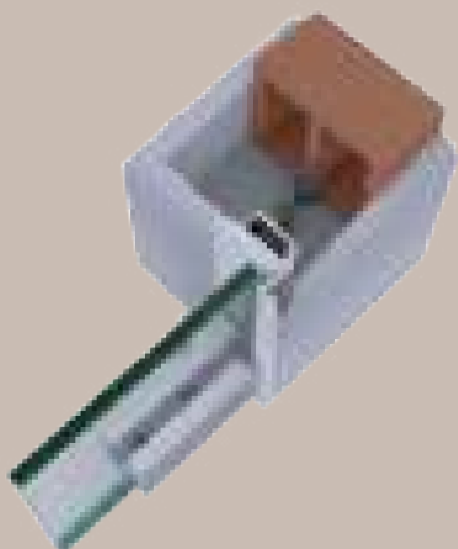



Laccate a Mano

---

PANTOINCISA  
BP 1034

---

Apertura / Opening  
Battente / Hinged

---

Tipologia / Typology  
Minima

---

Finitura / Finish  
Laccato opaco Bianco  
Bianco matt lacquered

---

Maniglia / Handle  
Carol

---











Essenza Legno

DOGA HORI

Apertura / Opening  
Scorrevole a  
scomparsa /  
Pocket door

Finitura / Finish  
Noce Canaletto

Maniglia / Handle  
Unghiata Kuader

Essenza Legno

DOGA HORI

Apertura / Opening  
Battente / Hinged

Tipologia / Typology  
Minima

Finitura / Finish  
Noce Canaletto

Maniglia / Handle  
Mondrian

## IL LEGNO PROTAGONISTA

Il vero legno è un importante plus della collezione Essenza Legno. Sono proposti legni pregiati ed attuali come il Rovere laccato a poro aperto e il Noce Canaletto, qui rappresentato con una venatura importante, un unicum sempre diverso, originale e raffinato.

/ Real wood is an important extra in the Essenza Legno collection.

Available in quality, contemporary woods such as Rovere laccato a poro aperto and Noce Canaletto, shown here with a pronounced grain, giving you unique doors that are both original and refined.



Essenza Legno

---

DOGA HORI

---

Apertura / Opening  
Battente / Hinged

---

Tipologia / Typology  
Media

---

Finitura / Finish  
Rovere Sbiancato

---

Maniglia / Handle  
Bilbao

---









Essenza Legno

---

DOGA HORI  
ALL 1

---

Apertura / Opening  
Battente / Hinged

---

Tipologia / Typology  
Media

---

Finitura / Finish  
Rovere Sbiancato

---

Maniglia / Handle  
Dada

---

## ESSENZA LEGNO FILOMURO

Le versioni ALL presentano raffinati intarsi in alluminio complanari: semplici, lineari geometrie che definiscono campiture in essenza dalle armoniose tonalità. / ALL Models with refined, seamless aluminium inlays: simple geometric lines that outline timber panels in harmonious tones.

Filomuro timber panels

### INSERTI ALL / ALL INSERTS



ALL 1



ALL 2

Le porte della collezione Filomuro possono essere personalizzate con gli inserti orizzontali in alluminio. / Doors in the Filomuro collection can be customized with the horizontal aluminum inserts.







Laccate a Mano

---

PANTOINCISA  
BP 1006

---

Apertura / Opening  
Battente / Hinged

---

Tipologia / Typology  
Plus

---

Finitura / Finish  
Laccato opaco Quarzo  
Quarzo matt lacquered

---

Maniglia / Handle  
Dada

---

BATTISCOPIA  
FILOMURO

---

Finitura / Finish  
Laccato opaco Quarzo  
Quarzo matt lacquered

Laccate a Mano

CL

Apertura / Opening  
Battente / Hinged

Tipologia / Typology  
Bidirezionale

Finitura / Finish  
Laccato lucido Quarzo  
Quarzo glossy lacquered

Maniglia / Handle  
Tiempo

FILOMURO BIDIREZIONALE PER CARTONGESSO /  
DRYWALL





Laccate a Mano

PANTOQUADRA  
LP8

Apertura / Opening  
Battente / Hinged

Tipologia / Typology  
Bidirezionale

Finitura / Finish  
Laccato Ghiaia

Maniglia / Handle  
Chef



## APERTURA BIDIREZIONALE



Porta modello LP8 Bidirezionale con apertura a spinta e a tirare. La tecnologia applicata ai sistemi di apertura consente soluzioni innovative e funzionali. / Bidirectional opening - LP8 model bidirectional door, push or pull opening. The technology applied to the opening system allows for innovative and functional solutions.

## NATURA

Una collezione creativa che riporta nel living contemporaneo un'idea di naturalità. Così il "paesaggio" domestico assume nuove forme espressive e grafiche. / A creative collection that brings the idea of nature into contemporary living, so your domestic 'landscape' takes on new expressive shapes and design.









Le Originali Bertolotto®

NATURA  
TREE

Apertura / Opening  
Battente / Hinged

Tipologia / Typology  
Minima

Finitura / Finish  
Laccato colore RAL /  
RAL lacquered colour

Maniglia / Handle  
Bilbao

Sistemi di Design

CRYSTAL 3255  
TREE

Apertura / Opening  
Battente / Hinged

Tipologia / Typology  
Minima Crystal

Profilo / Frame  
Brown

Vetro / Glass  
Stop-sol Bronzo  
Sabbiato

Maniglia / Handle  
Toledo

BATTISCOPIA  
FILOMURO PRIMER





Le Originali Bertolotto®

NATURA  
SOFFI

Apertura / Opening  
Battente / Hinged

Tipologia / Typology  
Minima

Finitura / Finish  
Laccato opaco RAL/  
RAL matt lacquered

Maniglia / Handle  
Chef

Le Originali Bertolotto®

ALASKA 3245  
SOFFI

Apertura / Opening  
Battente / Hinged

Tipologia / Typology  
Minima Alaska

Vetro / Glass  
Trasparente Extrachiaro  
sabbaiato

Maniglia / Handle  
Chef

Le Originali Bertolotto®

---

NATURA  
ULIVO

---

Apertura / Opening  
Battente / Hinged

---

Tipologia / Typology  
Massima

---

Telaio / Frame  
Laccato opaco Bianco /  
Bianco matt lacquered

---

Maniglia / Handle  
Ara

---

BATTISCOPIA  
FILOMURO

---

Finitura / Finish  
Laccato opaco  
Bianco / Bianco matt  
lacquered





## NATURA FILOMURO

La collezione Natura 3D, proposta con decorazioni a rilievo, è un'altra originale interpretazione del design di una porta. Segni che creano un gioco di luce e ombra sulle superfici. / The Natura 3D collection, with patterns in relief, is another original interpretation of door design with graphics that create a play of light and shadow on the surfaces.









Le Originali Bertolotto®

---

NATURA 3D  
ORCHIDEA

---

Apertura / Opening  
Battente / Hinged

---

Tipologia / Typology  
Media

---

Finitura / Finish  
Laccato opaco Bianco  
Bianco matt lacquered

---

Maniglia / Handle  
Bilbao

---

Effetto Legno

---

111 M

---

Apertura / Opening  
Battente / Hinged

---

Tipologia / Typology  
Plus

---

Finitura / Finish  
Cemento

---

Maniglia / Handle  
Ara

Filomuro presenta finiture di pregio come le essenze lignee oppure i laccati lisci o poro aperto in tutta la cartella RAL / NCS, ma sono anche proposte finiture più tecniche come i laminati ad alta resistenza della collezione Effetto Legno. / Filomuro has quality finishes in timber and either smooth or open pore lacquers from the entire RAL/NCS chart, as well as more technical finishes such as high resistance laminates from the Effetto Legno collection.



Effetto Legno

---

111 M

---

Apertura / Opening

Battente / Hinged

---

Tipologia / Typology

Plus

---

Finitura / Finish

Materik Bianco

---

Maniglia / Handle

Ara



## FILOMURO METROMAP

Metromap è un'idea ispirata all'underground style per personalizzare la porta, per riportare all'interno degli ambienti un riferimento ai percorsi metropolitani. Il segno può essere inciso su legno o su vetro. / Metromap is an idea inspired by the style of the underground to customise your doors, bringing an allusion to metro routes into your home. The designs can be cut into wood or glass.









Le Originali Bertolotto®

METROMAP  
LONDON

Apertura / Opening  
Scorrevole a  
scomparsa /  
Pocket door

Tipologia / Typology  
Vetro inciso /  
Engraved glass

Finitura / Finish  
Satinato Extrachiaro

Maniglia / Handle  
Slide



Le Originali Bertolotto®

---

METROMAP  
BERLIN

---

Apertura / Opening  
Battente / Hinged

---

Tipologia / Typology  
Minima

---

Finitura / finish  
Laccato opaco Bianco /  
Bianco matt lacquered

---

Maniglia / Handle  
Tiempo

---

Le Originali Bertolotto®

BRITTO LOVES BERTOLOTTO  
FRIENDSHIP BEAR

Apertura / Opening  
Battente / Hinged

Tipologia / Typology  
Media

Maniglia / Handle  
Dada

FILOMURO MEDIA PER MURATURA / MASONRY





## BRITTO LOVES BERTOLOTTI FILOMURO

La Pop Art ed il colore sono gli elementi identificativi dello stile “Britto”: l’allegria che traspare dalle sue grafiche sta invadendo il mondo del design e dell’arte. Il linguaggio utilizzato dall’artista è trasversale, e ben si presta alla decorazione. / Pop Art and colors are the identifying features of Britto’s style: the joy that shines through his artwork is conquering the world of art and design. The artist’s language is transversal and well suited to decoration.









Le Originali Bertolotto®

CASA ZEN

---

Apertura / Opening  
Battente / Hinged

---

Tipologia / Typology  
Media

---

Finitura / Finish  
Takla

---

Maniglia / Handle  
Parrot





---

Laccate a Mano

ALASKA 3604

---

Apertura / Opening  
Battente / Hinged

---

Tipologia / Typology  
Minima Alaska

---

Finitura / Finish  
Extrachiario Acidato

---

Maniglia / Handle  
Basco

## SURFACE METALLI FILOMURO

Nuove finiture che appartengono alla contemporaneità sono proposte per allargare gli orizzonti progettuali della collezione Filomuro. Sono finiture metalliche come il Ferro Ruggine o l'Ottone Ossidato di grande personalità. / New contemporary finishes are available to extend the design range of the Filomuro collection. Metal finishes such as Ferro Ruggine (rusted iron) or Ottone Ossidato (oxidised brass) have plenty of character.



Sistemi Filomuro

SURFACE  
METALLI

Apertura / Opening  
Battente / Hinged

Tipologia / Typology  
Minima

Finitura / Finish  
Ferro Ruggine

Maniglia / Handle  
Basco







## SURFACE

Queste superfici dal design ricercato e attuale sono proposte originali per l'interior decoration, nel segno di una personalità distintiva. / The refined and contemporary style of these surfaces are an original idea for interior decoration and a sign of a distinctive personality.







Sistemi Filomuro

SURFACE

Apertura / Opening  
Battente / Hinged

Tipologia / Typology  
Minima

Finitura / Finish  
Ottone Ossidato

Maniglia / Handle  
Bilbao

Sistemi Filomuro

SURFACE

Apertura / Opening  
Scorrevole a  
scomparsa /  
Pocket door

Finitura / Finish  
Ottone Ossidato

Maniglia / Handle  
Unghiata Kuader

BATTISCOPIA  
FILOMURO PRIMER



Sistemi Filomuro

---

SURFACE

---

Apertura / Opening  
Battente / Hinged

---

Tipologia / Typology  
Media

---

Finitura / Finish  
Stagno Ossidato

---

Maniglia / Handle  
Basco

---

BATTISCOPA  
FILOMURO PRIMER

---



## SURFACE METALLI

Finiture metalliche e ossidate cercano un punto di contrasto creato ad arte con gli altri materiali fanno parte del mood dell'ambientazione contemporanea. / Metal and rusted finishes give a purposely created point of contrast with other materials and help set the mood for a contemporary ambience.





# METALLI / SURFACE



RAME



RAME OSSIDATO



STAGNO

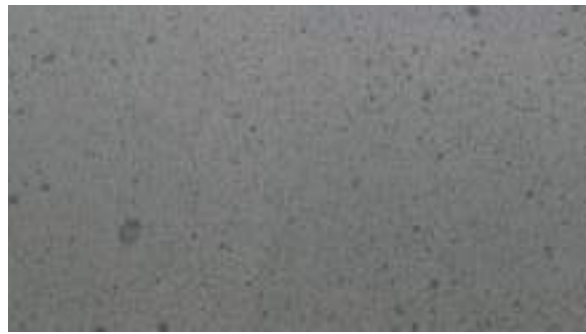

STAGNO OSSIDATO



OTTONE

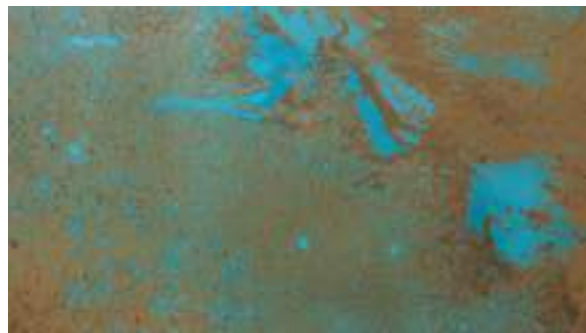

OTTONE OSSIDATO



FERRO



FERRO RUGGINE



BRONZO



BRONZO OSSIDATO







Effetto Legno

---

MATERIK

---

Apertura / Opening  
Battente / Hinged

---

Tipologia / Typology  
Minima

---

Finitura / Finish  
Cemento

---

Maniglia / Handle  
Basco

---

## FINITURA MATERIK CEMENTO

L'attualissima finitura Materik Cemento si affianca alle finiture Effetto Legno, Laccate e Surface per un planning di sicuro pregio estetico. / The ultra-contemporary Materik Cemento finish is added to the Effetto Legno (wood-effect), lacquered and Surface treated range for a project of real aesthetic value.



Effetto Legno

GRAFITE

Apertura / Opening  
Battente / Hinged

Tipologia / Typology  
Media

Finitura / Finish  
Grano

Maniglia / Handle  
Dada

I decorativi della collezione Grafite si sviluppano sull'anta in senso orizzontale per tutte le misure standard. In caso di porte fuori misura con altezza da 211 a 270 cm la venatura Effetto Legno si sviluppa in senso verticale. / The textured patterns of Grafite collection decorate the door panel horizontally for all standard sizes, with non-standard size doors with a height from 211 to 270 cm the wood grain effect is in a vertical pattern.







## FINITURA GRAFITE GRANO

Raffinate finiture Effetto Legno si armonizzano in ogni contesto d'arredo donando un senso di naturalità all'habitat contemporaneo. / Refined wood-effect finishes harmonise in any interior design context bringing a feeling of nature into a contemporary habitat.

Grafite Grano finish







Effetto Legno

MATERIK

Apertura / Opening  
Battente / Hinged

Tipologia / Typology  
Minima

Finitura / Finish  
Bruno

Maniglia / Handle  
Dada

I decorativi della collezione Materik si sviluppano sull'anta in senso orizzontale per tutte le misure standard. In caso di porte fuori misura con altezza da 211 a 270 cm la venatura Effetto Legno si sviluppa in senso verticale. / The textured patterns of the Materik collection decorate the door panel horizontally for all standard sizes, with non-standard size doors with a height from 211 to 270 cm the wood grain effect is in a vertical pattern.

## FINITURA MATERIK BRUNO

Materik propone un effetto legno ottenuto con venature marcate, tattili e resistenti all'urto e all'abrasione. Diverse tonalità del legno interpretano il living contemporaneo. / Materik is a wood effect with a marked grain, it is pleasant to touch, scratch and shock proof. Different shades of wood interpret contemporary living.

Materik bruno finish



## MATERIK VETRO ACIDATO E 3D

Materik propone versioni in vetro acidato su base satinato extrachiaro associate a porte scorrevoli o battenti. Un ulteriore, raffinata possibilità di progetto per architetti e interior designers. / Materik includes models in etched glass on an extra clear opaque base for sliding or hinged doors. A further, refined design option for architects and interior designers.

Materik etched and 3D glass





Effetto Legno

MATERIK VETRO

---

Apertura / Opening  
Scorrevole a  
scomparsa /  
Pocket door

---

Tipologia / Typology  
Vetro / Glazing

---

Finitura / Finish  
Acidato base  
Satinato Extrachiario

---

Maniglia / Handle  
Slide





## CRISTALLI PREZIOSI

Il disegno del legno Materik è proposto acidato su vetro Satinato Extrachiaro oppure 3D effetto rilievo. Materiali di assoluto pregio valorizzano l'habitat contemporaneo. / The Materick wood pattern is available etched on opaque extra clear glass or in a 3D relief effect. High quality materials that do justice to contemporary habitats.







## FILOMURO CRYSTAL

---

Porta battente Filomuro  
con struttura in alluminio  
Hinged flush-fitting door  
with aluminium frame

Le porte a battente Filomuro sono frutto dell'esperienza progettuale e realizzativa del gruppo Bertolotto. Grazie a questa sinergia di expertise, è stato possibile riunire in un'unica collezione i valori e le idee del design contemporaneo a cui è stata data una "veste" tecnologica di grande fascino espressivo. Le porte Filomuro sono proposte a misura anche in altezze esasperate, per soddisfare ogni esigenza di interior design.

Hinged flush doors are the fruit of the Bertolotto group's years of experience in designing and manufacturing doors. This synergy of expertise has allowed us to unite the values and ideas of contemporary design with the charm of technology in one unique collection. Filomuro flush doors are also available made to measure, even for extremely high doorways, to satisfy your every interior design need.

## CRYSTAL BI DOPPIO BATTENTE

La tecnologia applicata ai sistemi di apertura consente la configurazione di porte a doppio battente con chiusura magnetica, per un perfetto allineamento dei battenti, lasciando il disegno della porta pulito ed essenziale. / The technology used on the opening systems allows you to fit double doors with magnetic pull closing, for perfectly aligned doors with clean minimalist lines.

Crystal BI double hinged version

FILOMURO CRYSTAL BI DOPPIO BATTENTE /  
DOUBLE HINGED

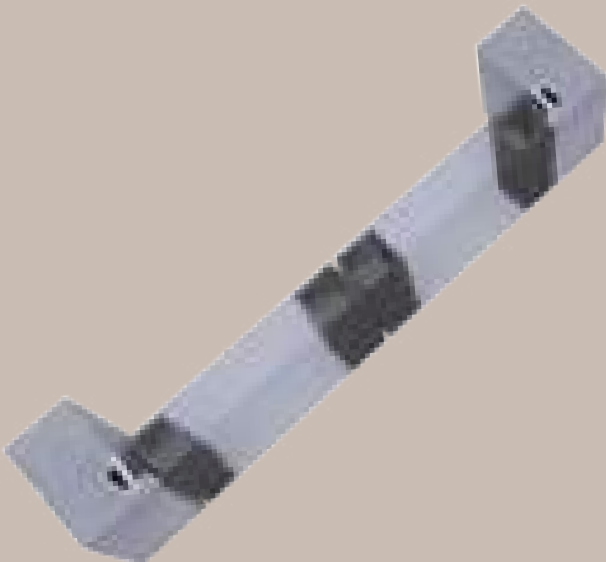





Sistemi di Design

---

CRYSTAL BI  
FILOMURO

---

Apertura / Opening  
Doppio battente /  
Double hinged

---

Tipologia / Typology  
Minima Crystal BI

---

Profilo / Frame  
Antracite

---

Vetro / Glazing  
Stop-sol trasparente

---

Maniglia / Handle  
Toledo

---

BATTISCOPIA  
FILOMURO PRIMER





## COLLEZIONE FILOMURO: DESIGN E RIGORE ESTETICO

La collezione Filomuro presenta un design rigoroso ed essenziale che si armonizza con ogni tipologia di arredo. Le Filomuro si “eclissano” all’interno della parete oppure sorprendono con le loro finiture di pregio. / The Filomuro collection presents a precise and basic design that harmonises with any type of furnishing. The Filomuro flush doors blend into the wall or surprise with their quality finishes.



Sistemi di Design

CRYSTAL  
FILOMURO

Apertura / Opening  
Battente / Hinged

Tipologia / Typology  
Minima Crystal

Profilo / Frame  
Brown

Vetro / Glazing  
Trasparente  
Extrachiario

Maniglia / Handle  
Basco

Sistemi di Design

CRYSTAL  
FILOMURO

Apertura / Opening  
Scorrevole a  
scomparsa /  
Pocket door

Profilo / Frame  
Brown

Vetro / Glazing  
Laccato Canapa /  
Canapa Lacquered

Maniglia / Handle  
Link















Sistemi di Design

---

CRYSTAL  
FILOMURO

---

Apertura / Opening  
Battente / Hinged

---

Tipologia / Typology  
Minima

---

Profilo / Frame  
Brown

---

Vetro / Glazing  
Stop-sol

---

Maniglia / Handle  
Basco

---

## CRYSTAL BATTENTE

La porta Crystal battente presenta un'anta con profilo in alluminio nelle finiture Argento, Antracite, Brown e Bianco. Crystal è monovetro, mentre Crystal BI presenta un doppio vetro. / The hinged Crystal door has a leaf with an aluminum profile and is available in the following finishes: Argento, Antracite, Brown and Bianco. Crystal is single glazed while Crystal BI has double glazing.

Crystal hinged version



Sistemi di Design

CRYSTAL  
FILOMURO

Apertura / Opening  
Scorrevole a  
scomparsa /  
Pocket door

Profilo / Frame  
Brown

Vetro / Glazing  
Satinato Extrachiaro

Maniglia / Handle  
Link





## CRYSTAL SCORREVOLE A SCOMPARSA

La porta Crystal è proposta sia nella versione battente che nella versione scorrevole a scomparsa anta singola oppure doppia. Tipologie di vetro: trasparente, satinato, a specchio, Stop-sol, Reflex, Lino, Metal e vetri laccati in un'esclusiva selezione di colori. / The Crystal door is available in the hinged or pocket version with a single or double leaf. Types of glass: transparent, opaque, mirrored, Stop-sol, Reflex, Lino, Metal and lacquered glass in an exclusive selection of colours.

Crystal pocket version









Sistemi di Design

---

CRYSTAL  
FILOMURO

---

Apertura / Opening  
Battente / Hinged

---

Tipologia / Typology  
Minima Crystal

---

Profilo / Frame  
Argento

---

Vetro / Glazing  
Reflex Bronzo

---

Maniglia / Handle  
Geneve

---

## CRYSTAL / CRYSTAL BI

Il design della porta Crystal e Crystal BI si caratterizza da una struttura perimetrale in alluminio in diverse finiture celata da un vetro in luce con maniglia a incasso. Le porte sono realizzate a misura, dimensioni massime larghezza mm 1500 x 3000 altezza. / The doors Crystal and Crystal BI are manufactured with an aluminum perimeter structure in different finishes, concealed by a glass leaf with a recessed handle plate. The doors are made to measure, maximum width 1500 mm x 3000 mm height.



## CRYSTAL

Un ambiente dal carattere “nuovo classico” in cui boiserie ed elementi in stile sono associati ad una porta vetro dal design moderno: un tocco contemporaneo ideale per ambienti senza tempo. / An environment with a “new classic” feel where panelling and classic furnishings are combined with a modern design glass door: a contemporary touch ideal for creating timeless style.



Sistemi di Design

---

CRYSTAL  
FILOMURO

---

Apertura / Opening  
Battente / Hinged

---

Tipologia / Typology  
Minima Crystal

---

Profilo / Frame  
Antracite

---

Vetro / Glazing  
Satinato Extrachiaro

---

Maniglia / Handle  
Bilbao

---







Laccate a Mano

ALASKA 3002

Apertura / Opening  
Battente / Hinged

Tipologia / Typology  
Minima Alaska

Vetro / Glazing  
Trasparente Bronzo

Maniglia / Handle  
Vertigo

Laccate a Mano

CL

Apertura / Opening  
Battente / Hinged

Tipologia / Typology  
Minima

Finitura / Finish  
Laccato opaco Acciaio  
Acciaio matt lacquered

Maniglia / Handle  
Vertigo

BATTISCOPIA  
FILOMURO

Finitura / Finish  
Laccato opaco Acciaio  
Acciaio matt lacquered









Laccate a Mano

---

CL

Apertura / Opening  
Battente / Hinged

---

Tipologia / Typology  
Minima

---

Finitura / Finish  
Laccato opaco Bianco  
Bianco matt lacquered

---

Maniglia / Handle  
Vertigo

Sistemi di Design

---

CRYSTAL

Apertura / Opening  
Battente / Hinged

---

Tipologia / Typology  
Minima Crystal

---

Profilo / Frame  
Brown

---

Vetro / Glazing  
Trasparente Extrachiario

---

Maniglia / Handle  
Vertigo





Sistemi di Design

---

CRYSTAL

---

Apertura / Opening  
Battente / Hinged

---

Tipologia / Typology  
Minima Crystal

---

Profilo / Frame  
Antracite

---

Vetro / Glazing  
Stop-sol Grigio

---

Maniglia / Handle  
Vertigo

---

Laccate a Mano

---

CL

---

Apertura / Opening  
Battente / Hinged

---

Tipologia / Typology  
Minima

---

Finitura / Finish  
Laccato opaco Tortora /  
Tortora matt lacquered

---

Maniglia / Handle  
Vertigo

---







Laccate a Mano

---

CL

Apertura / Opening  
Battente / Hinged

---

Tipologia / Typology  
Minima

---

Finitura / Finish  
Laccato opaco Bianco  
Bianco matt lacquered

---

Maniglia / Handle  
Vertigo

Sistemi di Design

---

CRYSTAL

Apertura / Opening  
Battente / Hinged

---

Tipologia / Typology  
Minima Crystal

---

Profilo / Frame  
Brown

---

Vetro / Glazing  
Reflex satinato  
Bronzo

---

Maniglia / Handle  
Vertigo





Sistemi di Design

---

CRYSTAL

---

Apertura / Opening  
Battente / Hinged

---

Tipologia / Typology  
Minima Crystal

---

Profilo / Frame  
Antracite

---

Vetro / Glazing  
Stop-sol Fumè

---

Maniglia / Handle  
Toledo

---

## PORTE FILOMURO

Le porte Filomuro sono proposte in versione a battente oppure a scomparsa interno muro, a Tuttaltezza e a misura. Struttura in alluminio a vista, con superfici in diversi materiali: legno, cristallo, laminati Effetto Legno o laccati. / Our flush-fitting Filomuro doors are purchasable in hinged or pocket versions, made to measure and floor-to-ceiling. Visible aluminium structure, with door surfaces in a range of different materials: wood, glass, Effetto Legno (wood-effect) laminates or lacquered.



## LA FILOMURO CHE SI VEDE

Crystal: la Filomuro che si vede! In alternativa alle porte integrate nella parete, con carta da parati, rivestimenti tessili o tinteggiature, le porte Crystal si manifestano nel loro design essenziale ed elegante con superfici in vetro dai colori esclusivi / Crystal: the flush door you can see! An alternative to the Filomuro doors that blend into the wall with wallpaper, fabric coverings or paint, our Crystal doors reveal their minimalist and elegant design with glass surfaces in exclusive colours.

The flush door you can see



Sistemi di Design

---

CRYSTAL

---

Apertura / Opening  
Battente / Hinged

---

Tipologia / Typology  
Minima Crystal

---

Profilo / Frame  
Argento

---

Vetro / Glazing  
Trasparente Fumè

---

Maniglia / Handle  
Bilbao

---

Laccate a Mano

---

CL

---

Apertura / Opening  
Battente / Hinged

---

Tipologia / Typology  
Minima

---

Finitura / Finish  
Laccato lucido colore  
RAL / RAL colour  
gloss lacquered

---

Maniglia / Handle  
Bilbao







## PORTE FILOMURO DAL DESIGN ESCLUSIVO

Crystal presenta finiture in cristallo riflettente, satinato, trasparente oppure laccato in una vasta gamma di colori. I profili in alluminio sono disponibili nelle finiture Antracite, Brown, Argento e Bianco./ Crystal has finishes in reflective, satin, transparent or lacquered glass in a wide range of colors. The aluminium frames are available in the finishes Antracite, Brown, Argento and Bianco.



Sistemi di Design

CRYSTAL

Apertura / Opening  
Battente / Hinged

Tipologia / Typology  
Minima Crystal

Profilo / Frame  
Brown

Vetro / Glazing  
Reflex Satinato  
Bronzo

Maniglia / Handle  
Basco

Sistemi di Design

CRYSTAL

Apertura / Opening  
Scorrevole a  
scomparsa /  
Pocket door

Profilo / Frame  
Brown

Vetro / Glazing  
Reflex Satinato  
Bronzo

Maniglia / Handle  
Link





## FILOMURO

Porte Filomuro realizzabili a Tuttaltezza, su misura. Telaio iglobato alla parete, struttura dell'anta in alluminio, cristalli in diverse finiture: trasparenti, satinati, Stop-sol, riflettenti o laccati in un'esclusiva selezione di colori. / Filomuro doors can be made-to-measure, floor-to-ceiling. The frame is embedded in the wall, the door perimeter structure is in aluminium with a glass leaf available in different finishes: transparent, frosted, Stop-sol, reflective or lacquered in an exclusive selection of colours.









---

Sistemi di Design

CRYSTAL

---

Apertura / Opening  
Battente / Hinged

---

Tipologia / Typology  
Minima Crystal

---

Profilo / Frame  
Argento

---

Vetro / Glazing  
Laccato Grigio Nuvola /  
Grigio Nuvola Lacquered

---

Maniglia / Handle  
Basco

## CARTA DA PARATI PROTAGONISTA DELL'ARREDO

Con la collezione di porte Sistemi Filomuro è possibile personalizzare la parete con rivestimento murale coordinato alla finitura delle porte per ottenere un effetto decorativo di sicuro impatto. / With Sistemi Filomuro doors collection you can customize the wall with a wall covering that matches the finish of the doors, to have an overall decorative effect on the wall.

Wallpaper as a protagonist of the interior design







Sistemi Filomuro

---

PRIMER

---

Apertura / Opening  
Battente / Hinged

---

Tipologia / Typology  
Plus

---

Finitura / Finish  
Carta da parati /  
Wallpaper

---

Maniglione / Handle  
Todo

---

Sistemi Filomuro

---

PRIMER

---

Apertura / Opening  
Doppio Battente /  
Double Hinged

---

Tipologia / Typology  
Plus

---

Finitura / Finish  
Carta da parati /  
Wallpaper

---

Maniglione / Handle  
Todo

---

## DOPPIO BATTENTE FINITURA CEMENTO

Una porta a doppio battente può essere accostata ad una singola per il composé ideale. Il grande maniglione in acciaio satinato consente una presa ergonomica e sicura. / A double hinged door can be combined with a single door, for an ideal match. The large satin steel handle provides an ergonomic and safe grip.

Double hinged door with Cemento finish

Effetto Legno

---

111 M

Apertura / Opening  
Battente / Hinged

---

Tipologia / Typology  
Massima

---

Finitura / Finish  
Cemento

---

Maniglione / Handle  
Todo

Effetto Legno

---

111 M

Apertura / Opening  
Doppio Battente /  
Double Hinged

---

Tipologia / Typology  
Massima

---

Finitura / Finish  
Cemento

---

Maniglione / Handle  
Todo

BATTISCOPIA  
FILOMURO PRIMER









Sistemi Filomuro

---

PRIMER

---

Apertura / Opening  
Battente / Hinged

---

Tipologia / Typology  
Minima

---

Finitura / Finish  
Pittura muraria /  
Wall paint

---

Maniglia / Handle  
Arya

---

Sistemi Filomuro

---

PRIMER

---

Apertura / Opening  
Battente / Hinged

---

Tipologia / Typology  
Minima

---

Finitura / Finish  
Carta da parati /  
Wallpaper

---

Maniglia / Handle  
Arya

---





## LE FILOMURO INTEGRATE A PARETE

Le porte Filomuro proposte con battuta Sky oppure con bordi nella finitura della porta, possono essere tinteggiate o rivestite con carta parati o tessuti. La porta scompare, diviene quasi invisibile, perfettamente integrata alla parete. / Filomuro doors are available with a Sky rabbet or with borders on the door edge, they can be painted or covered with wallpaper or fabric. The door disappears, becoming almost invisible, integrating perfectly into the wall.

Filomuro integrated into the wall



Sistemi Filomuro

PRIMER

Apertura / Opening

Double

Finitura / Finish

Pittura muraria /  
Wall painting

Maniglia / Handle

Dada

FILOMURO DOUBLÈ PER MURATURA / MASONRY

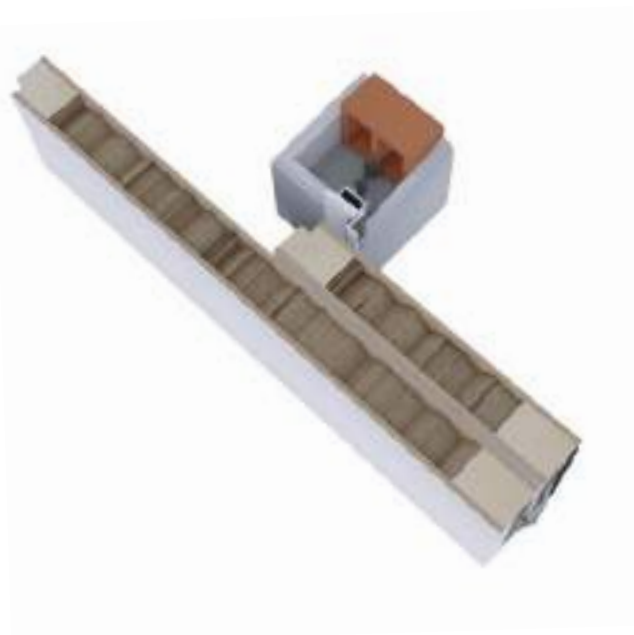



## IL COMPLANARE ALLA PARETE

Filomuro propone un moderno battiscopa dal design contemporaneo, incassato a filo parete, realizzato in finitura primer. Questa soluzione è particolarmente funzionale e crea la perfetta complanarità delle superfici.  
/ Filomuro presents a modern skirting board with a contemporary design, recessed flush to the wall and made with a primer finish. This solution is particularly useful and creates a perfectly smooth line between wall and skirting board.

Flush to the wall





## LUCI LED INTEGRATE



Con l'impiego di battiscopa complanari dotati di luci Led si possono delineare percorsi in sicurezza sia per scale che per zone rialzate. Questa particolare applicazione conferisce all'ambiente un look decisamente contemporaneo e accattivante. / INTEGRATED LED LIGHTS - By using flush skirting boards with integrated LED lights, you can outline safe paths both for stairs and raised areas. This distinctive configuration gives the room a definitely appealing and contemporary look.



## VANI / NICCHIE / ARMADI

Sistema di chiusura ad ante per piccoli vani, grandi cavedi di servizio ispezionabili, frontali di armadi ricavati nel muro. Questo sistema costituito da quattro elementi (telaio incassato, anta, cerniere e sistema di chiusura push-pull) garantisce la complanarità dell'apertura sulla parete e la continuità in termini cromatici e materici, grazie alla tinteggiabilità degli elementi a vista. / Closing systems for small spaces, large inspection hatches, built-in cupboard doors. This system consists of four components (recessed frame, leaf, hinge and push-pull closing system) ensuring a flush opening on the wall and continuity in terms of colour and material since the visible elements can be painted.

Wall spaces

Ribassando verso l'interno le ante portandole a filo muro con il rivestimento complanare è anche possibile applicare lastre di ceramica, specchi molati o altri materiali. Le ante vengono prodotte in pannelli di MDF idrofugo che non teme umidità ed acqua; sui lati delle ante è applicato un primer tinteggiabile. / **By inserting the leaf to lie flush with the wall and the surrounding décor it can also be clad in tiles, mirrors or other materials. The leaf is made of water and damp proof MDF panels, which are coated in paintable primer.**



## VANI / NICCHIE / ARMADI

Piccoli vani, nicchie e spazi contenitori possono essere ricavati nel muro con chiusure push-pull con ante a filo effetto "invisibile". / Cupboards, niches and storage spaces can be incorporated into the wall with push pull closing and flush leaves for an "invisible" effect.









Filomuro armadi anta doppia, telaio a tre lati, maniglia Pomolo Quadro Spingi-tira cromo satinato. / Filomuro double door cupboard, three sided frame, Pomolo Quadro recessed push-pull handle in satin chrome.

## VANI / NICCHIE / ARMADI

Le nicchie Filomuro con chiusura push-pull consentono di celare all'interno del muro piccoli vani ispezionabili con facile accesso. / The Filomuro niches with push-pull closing allows you to conceal small, easy access spaces in the wall.



Wall spaces



## NICCHIE ISPEZIONABILI

Il telaio in alluminio scatolare è stato progettato per essere incassato nella partizione muraria sia in muratura che in cartongesso con anta singola oppure anta doppia. Il perimetro é sempre rifinito e le ante possono essere coordinate alle porte. / The aluminium frame has been designed to be embedded in partition walls both for masonry and drywall, with single or double doors. The perimeter is always carefully finished and the leaf surface can be matched to the doors.



Inspection hatches



# FILOMURO / MINIMA

Porta complanare con telaio perimetrale estruso in finitura bianca, trattabile con pitture murali e predisposto per l'ancoraggio sia su muratura tradizionale che su cartongesso. Il sistema viene fornito anche nella versione scorrevole a scomparsa. L'anta Filomuro Minima è di tipo tamburato di spessore mm 44 nella versione standard. / Flush door with white finish extruded perimeter frame, suitable for wall paint and set up to be anchored to drywall or masonry. The system can also be supplied in the pocket version. The standard Filomuro Minima leaf has a 44mm thick honeycomb core.

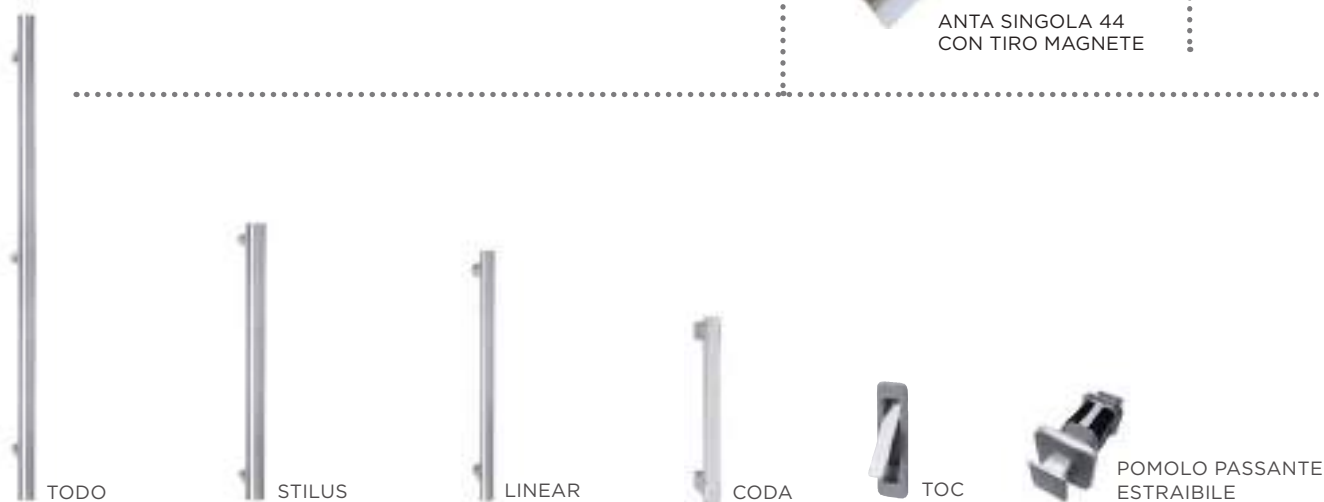

Su richiesta il sistema viene fornito con i modelli: Costellazioni, Arnaudo, Geometrica, Natura, Metromap, Britto, Casa Zen, Reflex, PantoNext, PantoQuadra, PantoClassica, PantoIncisa, CL, Glass, Alaska, Tranciato, Materik, Grafite, Surface e Primer. / On request on doors form the BP models: Costellazioni, Arnaudo, Geometrica, Natura, Metromap, Britto, Casa Zen, Reflex, Metal, Reflex, PantoNext, PantoQuadra, PantoClassica, PantoIncisa, CL, Fashion, Glass, Baltimora New, Alaska, Tranciato, Materik, Grafite, Surface, Primer can be supplied with the system.

FILOMURO MINIMA PER CARTONGESSO / DRYWALL  
Versione a spingere  
Push version



Versione a tirare  
Pull version



FILOMURO MINIMA PER MURATURA / MASONRY  
Versione a spingere  
Push version



Versione a tirare  
Pull version



FILOMURO MINIMA  
Versione doppio battente  
Double hinged version



DETTAGLIO FILOMURO MINIMA  
Versione doppio battente  
Double hinged version

Tiromagnete intermedio  
Intermediate thyromagnet



Tiromagnete superiore  
Upper thyromagnet



# FILOMURO / DOUBLÉ

Il sistema prevede l'utilizzo di un'anta di spessore 44 mm, asimmetrica 2/3, 1/3. La porta è costituita da telaio perimetrale in massello di legno pregiato essiccato netto di nodi, con battuta a bordo quadro e struttura interna di serie in alveolare pressato a caldo con fogli di MDF idro. Doublé è l'anta che si apre dividendosi, ideale per l'ambiente dove risparmiare lo spazio diventa necessario. Un design che sposa il concetto di tecnologia. / The system uses a leaf with a 44 mm thickness, asymmetrical 2/3, 1/3. The door is made of a perimeter frame in high-quality solid dried wood without knots, with a squared rabbet and a standard internal honeycomb structure made with hot-pressed waterproof MDF sheets. Doublé is the leaf that opens by folding in two, ideal for saving space. A design coupled with the concept of technology.



MAGNETICA  
CON CHIAVE UTILIZZATA  
ANCHE SU BATTENTI NO  
FORO CHIAVE



CERNIERE DI  
UNIONE



MAGNETICA  
CON CHIAVE



MAGNETICA  
CON YALE



MAGNETICA CON  
LIBERO OCCUPATO



CILINDRO  
CHIAVE/CHIAVE



CILINDRO  
CHIAVE/PENDENTE



Su richiesta il sistema viene fornito con i modelli: Natura, PantoNext (LP1, LP8, LP9, LP29, LP88), PantoQuadra, (LP1, LP7, LP8, LP9, LP28, LP29, LP33), PantoClassica (LP1, LP7, LP8, LP9, LP28, LP29, LP33), CL, Tranciato, Materik, Grafite, Surface e Primer. / On request on doors form the BP models: Natura, PantoNext (LP1, LP8, LP9, LP29, LP88), PantoQuadra, (LP1, LP7, LP8, LP9, LP28, LP29, LP33), PantoClassica (LP1, LP7, LP8, LP9, LP28, LP29, LP33), CL, Tranciato, Materik, Grafite, Surface, Primer can be supplied with the system.



FILOMURO DOUBLÉ PER CARTONGESSO / DRYWALL  
Versione anta chiusa  
Closed door version



Versione anta aperta  
Open door version



FILOMURO DOUBLÉ PER MURATURA / MASONRY  
Versione anta chiusa  
Closed door version



Versione anta aperta  
Open door version



# FILOMURO / BIDIREZIONALE

La soluzione Filomuro con apertura Bidirezionale è un sistema che unisce l'essenzialità di una porta a filo parete, senza telaio e coprifili a vista con la praticità del doppio movimento nelle due direzioni, a spingere e tirare. Il telaio in alluminio bianco è inglobato nella parete di muratura o cartongesso, rifinito con una base sovraverniciabile, che scompare alla vista. L'anta di spessore 44 mm è collegata al telaio con un sistema a pivot. / The Filomuro solution with Bi-directional opening is a system that unites the minimalism of a flush door without a visible frame or trim, with the practicality of a swing movement in both directions, push or pull. The white aluminium frame is incorporated into masonry or drywall and finished with a paintable base, to make it disappear from sight. The 44 mm thick leaf is connected to a frame with a pivot system.



MAGNETICA CON  
CHIAVE UTILIZZATA ANCHE  
SU BIDIREZIONALE  
NO FORO CHIAVE



CERNIERE PIVOT



MAGNETICA  
CON CHIAVE



MAGNETICA  
CON YALE



MAGNETICA CON  
LIBERO OCCUPATO



CILINDRO  
CHIAVE/CHIAVE



CILINDRO  
CHIAVE/PENDENTE



Su richiesta il sistema viene fornito con i modelli: Costellazioni, Arnaudo, Geometrica, Natura, Metromap, Britto, Casa Zen, Reflex, PantoNext, PantoQuadra, PantoClassica, PantoIncisa, CL, Tranciato, Materik, Grafite, Surface, Primer. / On request on doors form the BP models: Costellazioni, Arnaudo, Geometrica, Natura, Metromap, Britto, Casa Zen, Reflex, PantoNext, PantoQuadra, PantoClassica, PantoIncisa, CL, Tranciato, Materik, Grafite, Surface, Primer can be supplied with the system.

---

FILOMURO BIDIREZIONALE PER CARTONGESSO / DRYWALL



---

FILOMURO BIDIREZIONALE PER MURATURA / MASONRY



# FILOMURO / PLUS

Il nuovo sistema prevede un fissaggio idoneo per muratura e uno semplificato per cartongesso: per quest'ultimo è sufficiente avvitare il telaio alla struttura metallica della parete, senza l'utilizzo di staffe applicate o altri elementi aggiuntivi. La nuova struttura Plus, rigida e resistente alla torsione, garantisce maggiore stabilità e compattezza al sistema. La sagoma maggiorata del profilo telaio consente di realizzare più velocemente le angolature e le spigolature sia della muratura che del cartongesso. È disponibile a Tuttaltezza, il telaio Plus si può installare senza traverso superiore, per un effetto minimale e contemporaneo molto elegante e dinamico. La porta Filomuro Plus ha uno spessore di 44 mm. / The new system is available with installation suitable for masonry and a simplified system for drywall: for the latter you simply attach the frame to the metal structure of the wall without using applied rods or other added elements. The new Plus structure, rigid and structured, ensures greater stability and compactness to the system. The enlarged shape of the frame profile allows you to create corners and edges more quickly both in masonry and drywall. Available in full-height, the plus frame can be installed without the upper cross-beam for a minimalist and contemporary effect that is both elegant and dynamic. The Filomuro Plus doors features a 44 mm thick leaf.



MAGNETICA  
CON CHIAVE  
UTILIZZATA  
ANCHE SU  
BATTENTI NO  
FORO CHIAVE

MAGNETICA  
CON YALE

MAGNETICA CON  
LIBERO OCCUPATO

CILINDRO  
CHIAVE/CHIAVE



CILINDRO  
CHIAVE/PENDENTE



TIRO MAGNETE



ANTA SINGOLA 44  
CON TIRO MAGNETE



CERNIERE  
A SCOMPARSA  
REGOLABILI



TODO



STILUS



LINEAR



CODA



TOC



POMOLO PASSANTE

Su richiesta il sistema viene fornito con i modelli: Costellazioni, Arnaudo, Geometrica, Natura, Metromap, Britto, Casa Zen, Reflex, PantoNext, PantoQuadra, PantoClassica, PantoIncisa, CL, Tranciato, Materik, Grafite, Surface e Primer. / On request on doors form the BP models: Costellazioni, Arnaudo, Geometrica, Natura, Metromap, Britto, Casa Zen, Reflex, PantoNext, PantoQuadra, PantoClassica, PantoIncisa, CL, Tranciato, Materik, Grafite, Surface, Primer can be supplied with the system.

FILOMURO PLUS PER CARTONGESSO / DRYWALL  
Versione a spingere  
Push version



Versione a tirare  
Pull version



FILOMURO PLUS PER MURATURA / MASONRY  
Versione a spingere  
Push version

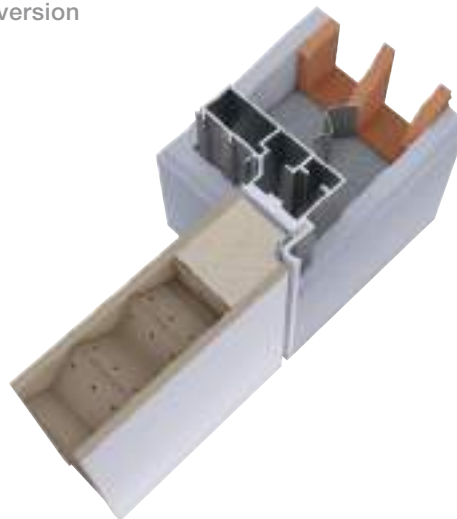

Versione a tirare  
Pull version



FILOMURO PLUS  
Versione doppio battente  
Double hinged version



DETTAGLIO FILOMURO PLUS  
Versione doppio battente  
Double hinged version

Tiromagnete intermedio  
Intermediate Tiromagnete



Tiromagnete superiore  
Upper Tiromagnete



# FILOMURO / MEDIA

Rappresenta una novità ad alte prestazioni: è caratterizzata da un anta di 58 mm di spessore. In fase di montaggio non occorre apportare tagli perimetrici sul cartongesso poichè quest'ultimo aderisce perfettamente nella sede ad angolo retto dedicata. / A new high-performance door: the Filomuro Media features a 58mm thick leaf. There is no need to cut the perimeter of the drywall during installation because it will adhere perfectly to the purpose built right-angled recess.

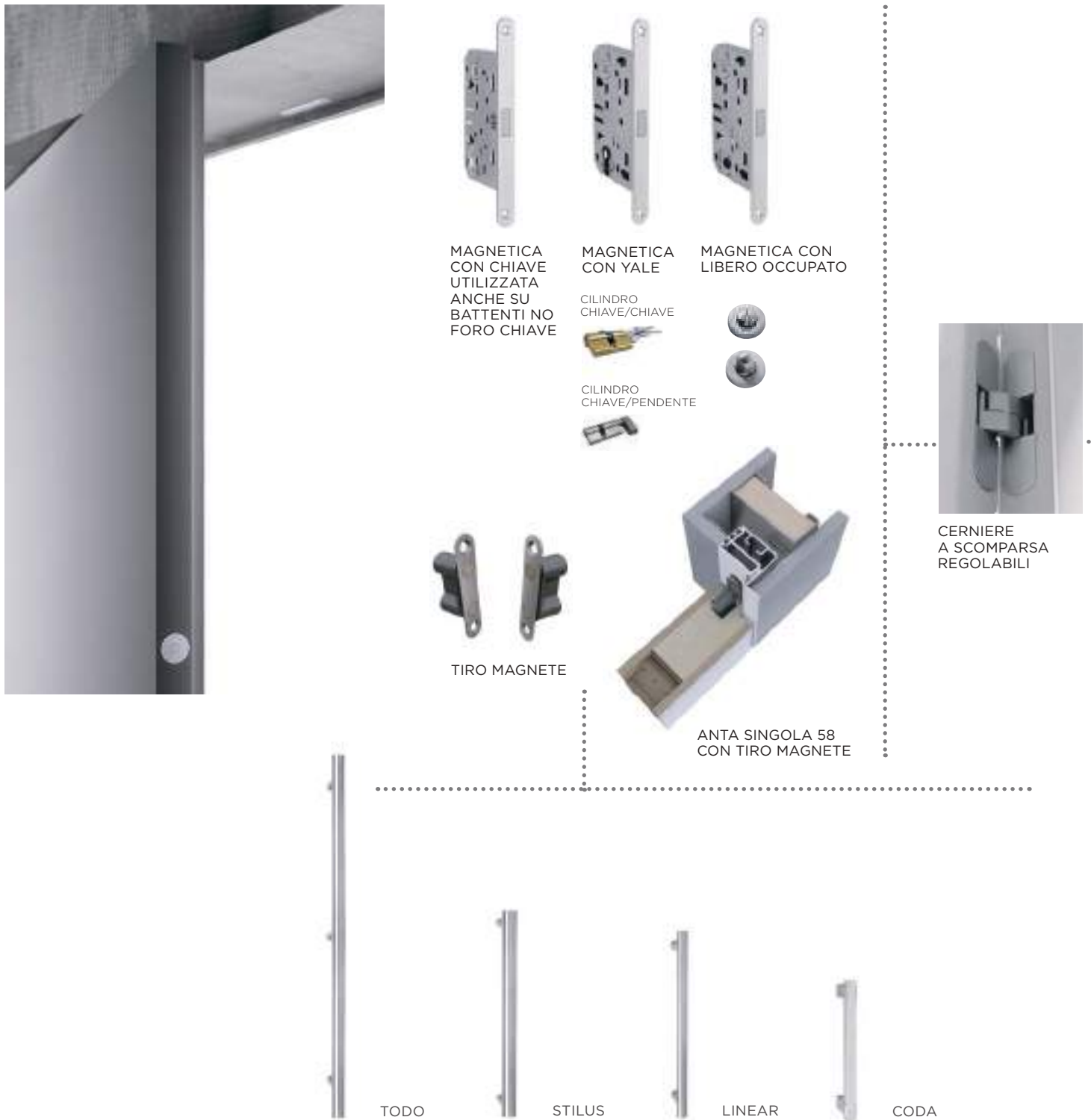

Su richiesta il sistema viene fornito con i modelli: Costellazioni, Arnaudo, Geometrica, Natura, Metromap, Britto, Casa Zen, Reflex, PantoNext, PantoQuadra, PantoClassica, PantoIncisa, CL, Tranciato, Surface e Primer. / On request on doors form the BP models: Costellazioni, Arnaudo, Geometrica, Natura, Metromap, Britto, Casa Zen, Reflex, PantoNext, PantoQuadra, PantoClassica, PantoIncisa, CL, Tranciato, Surface, Primer can be supplied with the system.

FILOMURO MEDIA PER CARTONGESSO / DRYWALL  
Versione a spingere  
Push version



Versione a tirare  
Pull version



FILOMURO MEDIA PER MURATURA / MASONRY  
Versione a spingere  
Push version



Versione a tirare  
Pull version



FILOMURO MEDIA  
Versione doppio battente  
Double hinged version



DETTAGLIO FILOMURO MEDIA  
Versione doppio battente  
Double hinged version

Tiromagnete intermedio  
Intermediate Tiromagnete



Tiromagnete superiore  
Upper Tiromagnete



# FILOMURO / MASSIMA

L'anta Massima di serie presenta uno spessore di 58 mm. Il sistema complanare a differenza degli altri modelli è corredato da una serie di allargamenti di differenti misure per coprire le principali dimensioni delle porzioni murarie standard presenti sul mercato. / The standard Massima leaf is 58 mm thick. The flush system differs from other models because it comes with a series of enlargements of different sizes to cover the main dimensions of standard wall elements present on the market.

Su richiesta il sistema viene fornito con i modelli: Costellazioni, Arnaudo, Geometrica, Natura, Metromap, Britto, Casa Zen, Reflex, PantoNext, PantoQuadra, PantoClassica, PantoIncisa, CL, Tranciato, Surface e Primer. / On request on doors form the BP models: Costellazioni, Arnaudo, Geometrica, Natura, Metromap, Britto, Casa Zen, Reflex, PantoNext, PantoQuadra, PantoClassica, PantoIncisa, CL, Tranciato, Surface, Primer can be supplied with the system.



MAGNETICA CON CHIAVE UTILIZZATA ANCHE SU BATTENTI NO FORO CHIAVE

MAGNETICA CON YALE

MAGNETICA CON LIBERO OCCUPATO

CILINDRO CHIAVE/CHIAVE

CILINDRO CHIAVE/PENDENTE



TIRO MAGNETE



CERNIERE A SCOMPARSA REGOLABILI



ANTA SINGOLA 58 CON TIRO MAGNETE



TODO



STILUS



LINEAR



CODA

## ALLARGAMENTI DISPONIBILI / ALLARGAMENTI DISPONIBILI





FILOMURO MASSIMA PER CARTONGESSO / DRYWALL  
Versione a spingere  
Push version



Versione a tirare  
Pull version



FILOMURO MASSIMA PER MURATURA / MASONRY  
Versione a spingere  
Push version



Versione a tirare  
Pull version



FILOMURO MASSIMA  
Versione doppio battente  
Double hinged version



DETTAGLIO FILOMURO MASSIMA  
Versione doppio battente  
Double hinged version

Tiromagnete intermedio  
Intermediate Tiromagnete



Tiromagnete superiore  
Upper Tiromagnete



# FILOMURO / CRYSTAL

---

Porta complanare in alluminio con vetro a filo temperato Monofacciale. Rappresenta l'unione ideale del design contemporaneo a cui è stata data una "veste" Tecnologica di grande fascino espressivo. realizzabile a Tuttaltezza, la struttura in alluminio e il cristallo di cui è composta l'anta sono disponibili in molteplici finiture a completa scelta del cliente. / Flush door in aluminium with single glazed tempered glass. This represents the perfect union between contemporary design and technology, resulting in an interesting and expressive solution. Available in full-height the structure in aluminium and the glass leaf are available in a variety of finishes at the choice of the client.



CERNIERE A SCOMPARSA  
CRYSTAL



MAGNETICA  
CON LO



MAGNETICA  
CON YALE



CILINDRO  
CHIAVE/CHIAVE



CILINDRO  
CHIAVE/PENDENTE

Su richiesta è possibile realizzare sabbiature relative ai modelli: Costellazioni, Arnaudo, Geometrica (BP1042, BP1013, BP1044, BP1045, BP1046, BP1047, BP1048), Natura, Metromap o altri decori su disegno di fattibilità. / On request it is possible to do sandblasted decorations on the models: Costellazioni, Arnaudo, Geometrica (BP1042, BP1013, BP1044, BP1045, BP1046, BP1047, BP1048), Natura, Metromap or others custom designs.

FILOMURO CRYSTAL PER CARTONGESSO / DRYWALL  
Versione a spingere  
Push version



Versione a tirare  
Pull version



FILOMURO CRYSTAL PER MURATURA / MASONRY  
Versione a spingere  
Push version

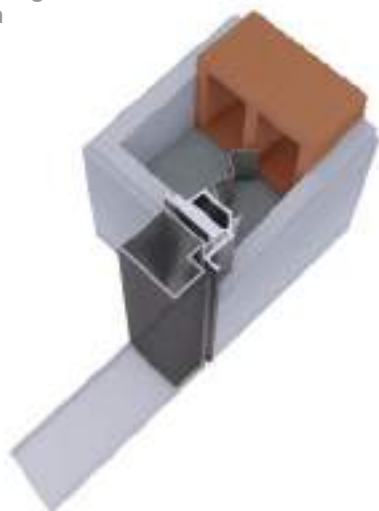

Versione a tirare  
Pull version



FILOMURO CRYSTAL  
Versione doppio battente  
Double hinged version



# FILOMURO / CRYSTAL BI

---

Porta complanare in alluminio con vetro a filo temperato Bifacciale. Rappresenta l'unione ideale del design contemporaneo a cui è stata data una "veste" Tecnologica di grande fascino espressivo. realizzabile a Tuttaltezza, la struttura in alluminio e il cristallo di cui è composta l'anta sono disponibili in molteplici finiture a completa scelta del cliente. / Flush door in aluminium with double glazed tempered glass. This represents the perfect union between contemporary design and technology, resulting in an interesting and expressive solution. Available in full-height the structure in aluminium and the glass leaf are available in a variety of finishes at the choice of the client.



CERNIERE A SCOMPARSA  
CRYSTAL



MAGNETICA  
CON LO



MAGNETICA  
CON YALE



CILINDRO  
CHIAVE/CHIAVE



CILINDRO  
CHIAVE/PENDENTE

Su richiesta è possibile realizzare sabbiature relative ai modelli: Costellazioni, Arnaudo, Geometrica (BP1042, BP1013, BP1044, BP1045, BP1046, BP1047, BP1048), Natura, Metromap o altri decori su disegno di fattibilità. / On request it is possible to do sandblasted decorations on the models: Costellazioni, Arnaudo, Geometrica (BP1042, BP1013, BP1044, BP1045, BP1046, BP1047, BP1048), Natura, Metromap or others custom designs.

FILOMURO CRYSTAL BI PER CARTONGESSO / DRYWALL  
Versione a spingere  
Push version



Versione a tirare  
Pull version



FILOMURO CRYSTAL BI PER MURATURA / MASONRY  
Versione a spingere  
Push version

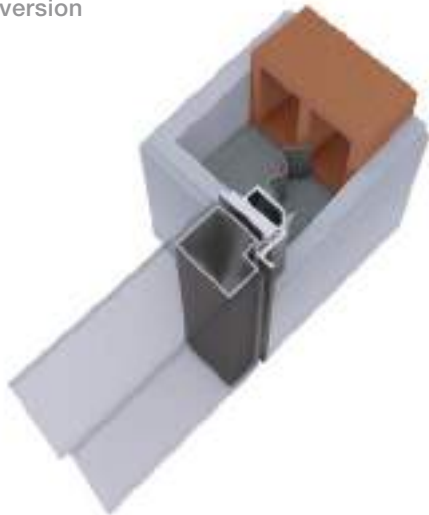

Versione a tirare  
Pull version

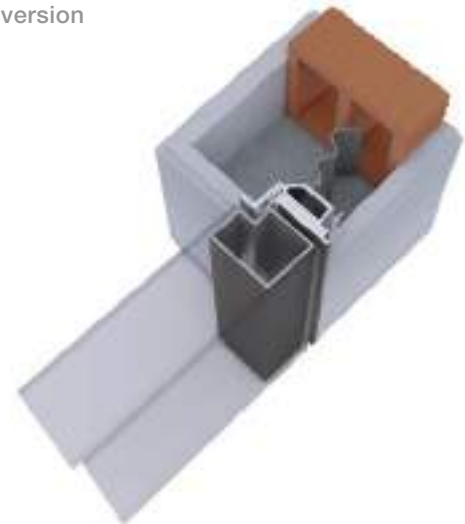

FILOMURO CRYSTAL BI  
Versione doppio battente  
Double hinged version



## FILOMURO / ALASKA

---

Il sistema prevede l'utilizzo di un'anta in vetro temperato di spessore 8 mm. La porta è disponibile nelle configurazioni battente o scorrevole a scomparsa. Disponibile unicamente nella versione anta singola a spingere, fino a dimensionamento massimo di 1200x2900 mm. / The system uses a door leaf in 8mm thick tempered glass. The door is available in the hinged or sliding pocket versions. Only available in the single door push version up to a maximum size of 1200x2900 mm.



CERNIERE ALASKA



MAGNETICA  
CON YALE

CILINDRO  
CHIAVE/CHIAVE



MAGNETICA



MAGNETICA CON  
LIBERO OCCUPATO



FILOMURO ALASKA PER CARTONGESSO / DRYWALL  
Disponibile nella versione a spingere  
Push version only

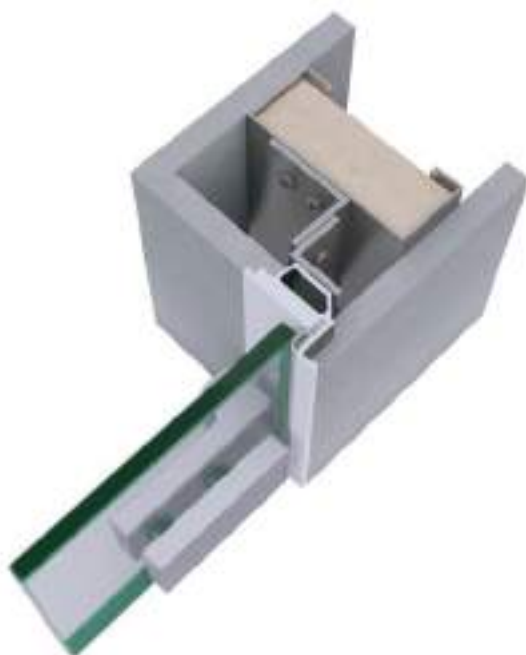

FILOMURO ALASKA PER CARTONGESSO / DRYWALL  
Disponibile nella versione a spingere  
Push version only

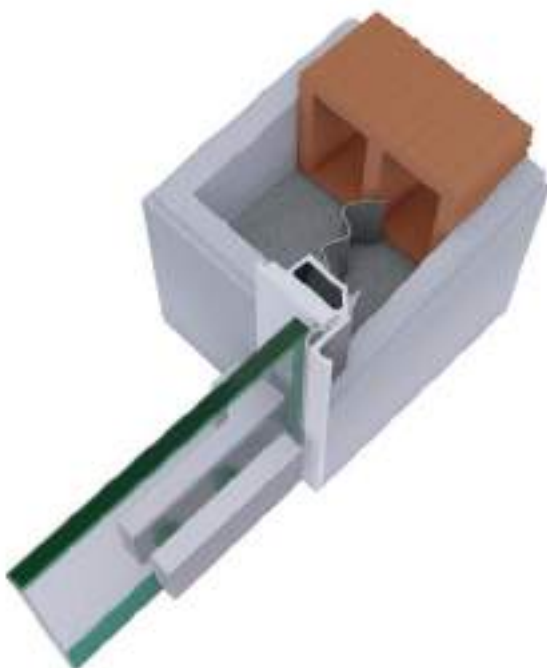

# FILOMURO / FINITURE FINISHES

**MINIMA**  
Muratura / Masonry



Cartongesso / Drywall



**DOUBLÈ**  
Muratura / Masonry



Cartongesso / Drywall



**BIDIREZIONALE**  
Muratura / Masonry



Cartongesso / Drywall



## LACCATI BP

BIANCO

SABBIA

TORTORA

FANGO

AVORIO

CIPRIA

GHIAIA

SETA

## PRIMER VERNICIABILE

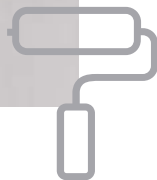



PLUS  
Muratura / Masonry



MEDIA  
Muratura / Masonry



MASSIMA  
Muratura / Masonry



Cartongesso / Drywall



Cartongesso / Drywall



Cartongesso / Drywall



FORESTA

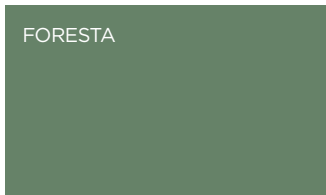

ACCIAIO

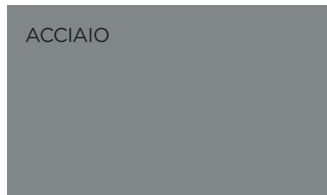

ROSSO

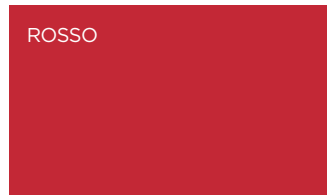

LACCATI RAL



QUARZO

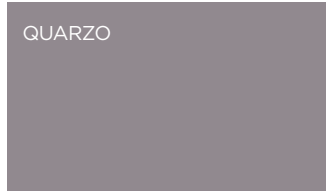

TURCHESE

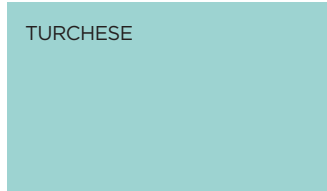

LACCATI NCS



**SURFACE**

RAME

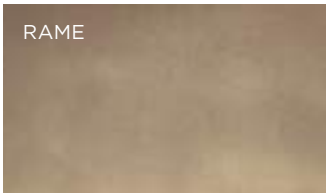

RAME OSSIDATO



STAGNO

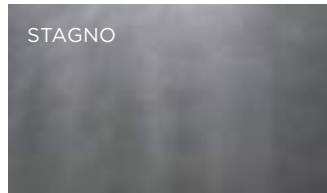

STAGNO OSSIDATO

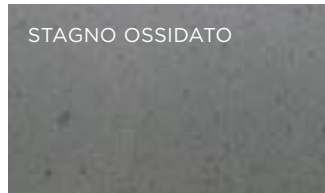

OTTONE

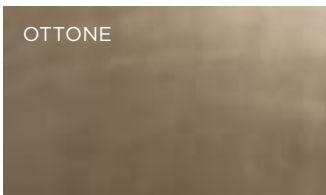

OTTONE OSSIDATO

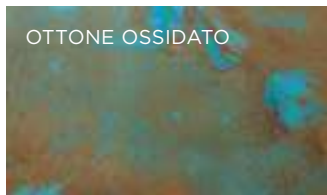

FERRO

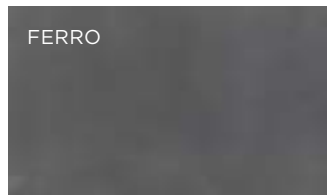

FERRO RUGGINE

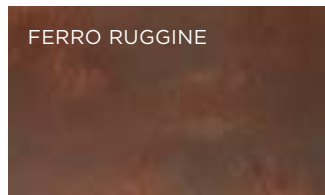

BRONZO

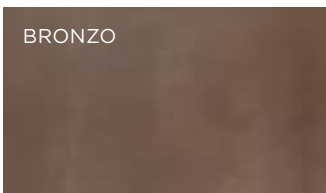

BRONZO OSSIDATO

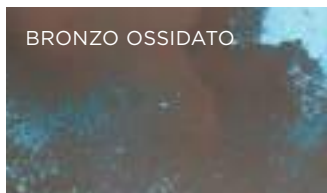

# FILOMURO / FINITURE FINISHES

**MINIMA**  
Muratura / Masonry



Cartongesso / Drywall



**DOUBLÈ**  
Muratura / Masonry



Cartongesso / Drywall



**BIDIREZIONALE**  
Muratura / Masonry



Cartongesso / Drywall



## ESSENZE LEGNO

TANGANICA MIELE



TANGANICA MEDIO

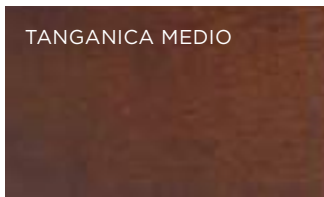

TANGANICA CILIEGIATO

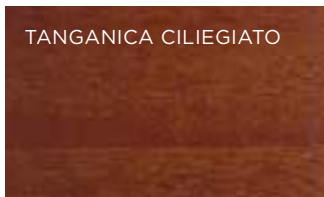

TANGANICA GRIGIO

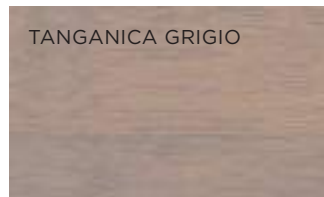

TANGANICA CANYON

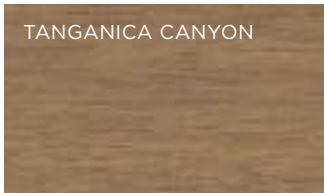

NOCE NAZIONALE  
STANDARD

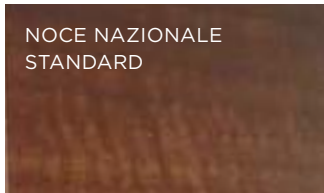

NOCE CANALETTO

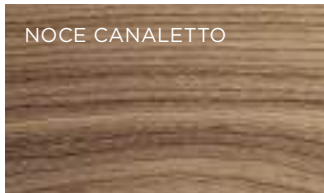

ROVERE MIELE



ROVERE NOCE

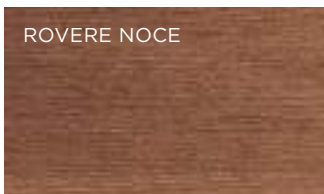

ROVERE SBIANCATO



ROVERE GREY

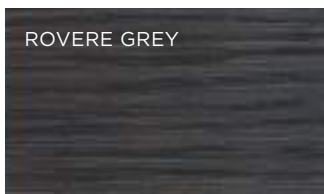

ROVERE CENERE

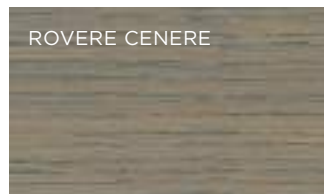

ROVERE TABACCO

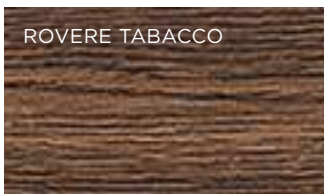

ROVERE SONOMA

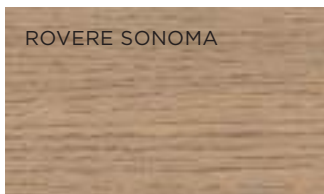

ROVERE OLIO OLIVO

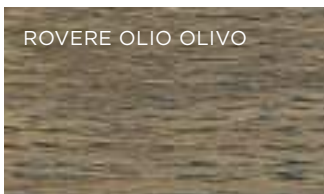

ROVERE OLIO NATURALE

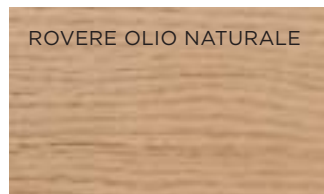

ROVERE OLIO CUOIO

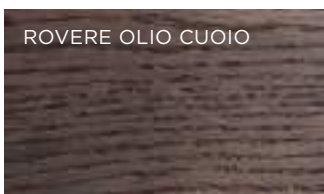

ROVERE OLIO ANTRACITE

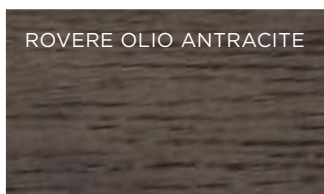

PLUS  
Muratura / Masonry



MEDIA  
Muratura / Masonry



MASSIMA  
Muratura / Masonry



Cartongesso / Drywall



Cartongesso / Drywall



Cartongesso / Drywall



**MATERIK**

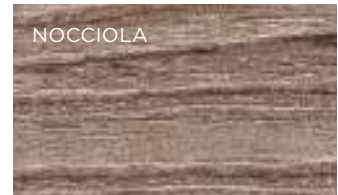

**GRAFITE**

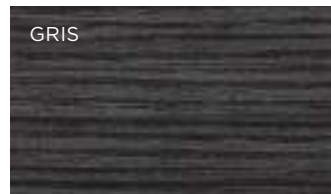
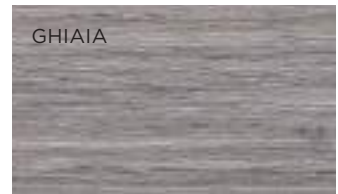

# CRYSTAL / FINITURE FINISHES

CRYSTAL  
Muratura / Masonry



CRYSTAL BI  
Muratura / Masonry



Cartongesso / Drywall



Cartongesso / Drywall



## PROFILO IN ALLUMINIO

BIANCO

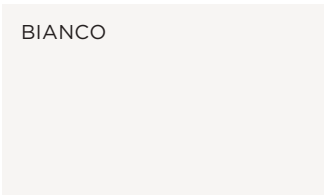

ALLUMINIO



ANTRACITE

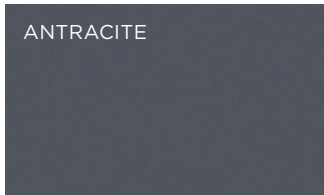

BROWN

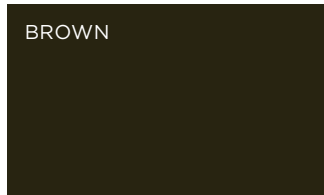

## FINITURE VETRI

BIANCO

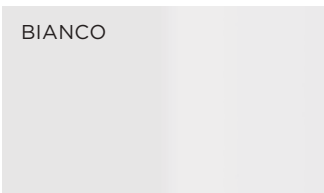

GRIGIO LUCE

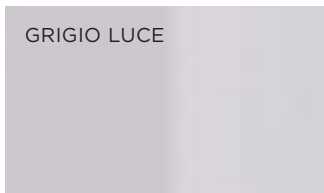

GRIGIO NUVOLA



MAGNOLIA

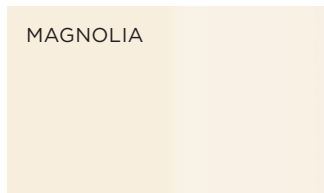

CANAPA

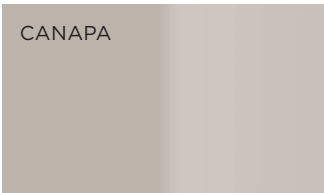

TERRA

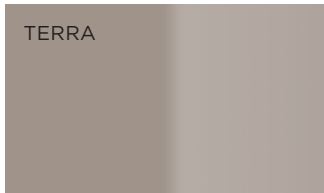

CENERE

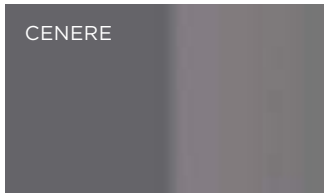

TORTORA

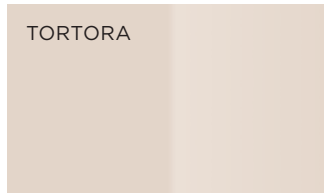

MARINA



PETROLIO

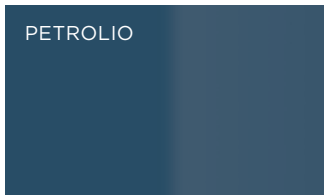

GRAFITE

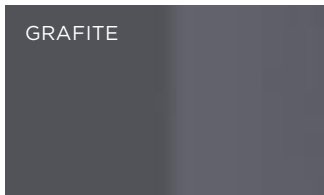

NERO

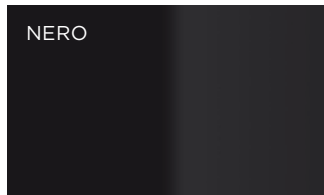

SATINATO BIANCO  
EXTRACHIARO



SATINATO BIANCO

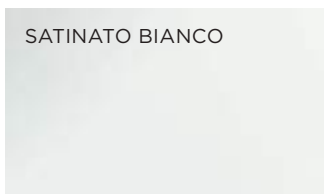

SATINATO GRIGIO

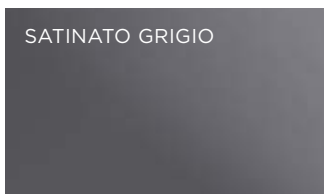

SATINATO BRONZO

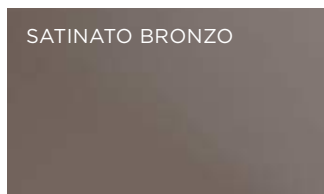

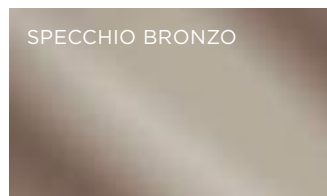
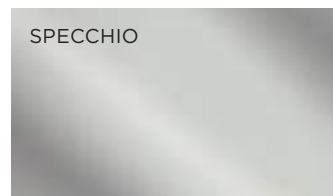
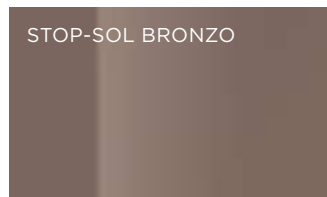
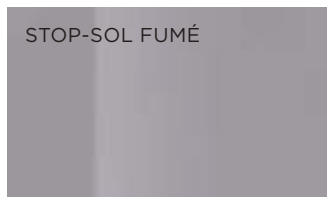
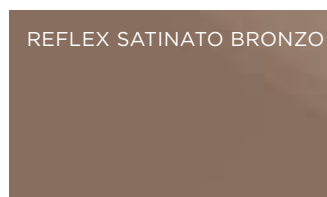
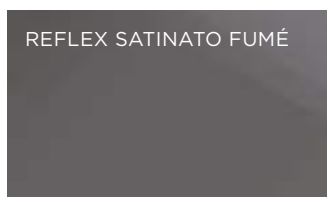
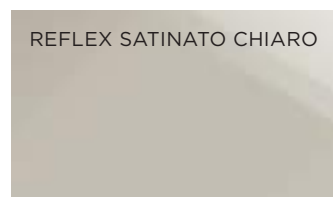
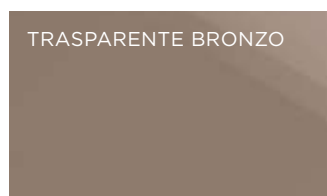

# ALASKA / FINITURE FINISHES

ALASKA  
Muratura / Masonry



Cartongesso / Drywall



## FINITURE ALASKA

TRASPARENTE  
EXTRACHIARO



TRASPARENTE GRIGIO



TRASPARENTE BRONZO

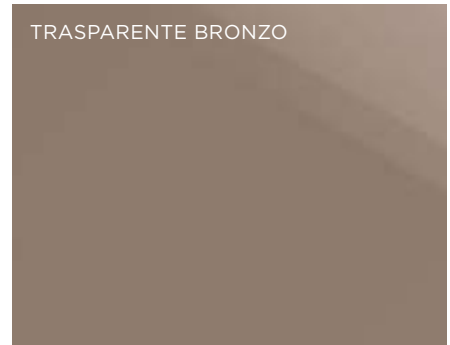

SATINATO BIANCO  
EXTRACHIARO



SATINATO GRIGIO



SATINATO BRONZO



STOP-SOL GRIGIO

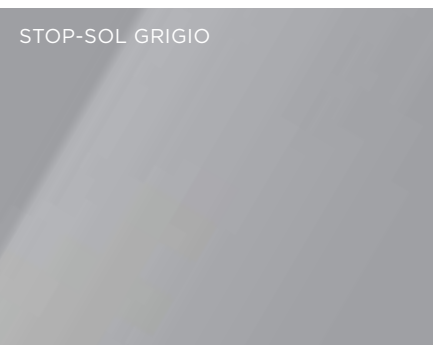

STOP\_SOL BRONZO

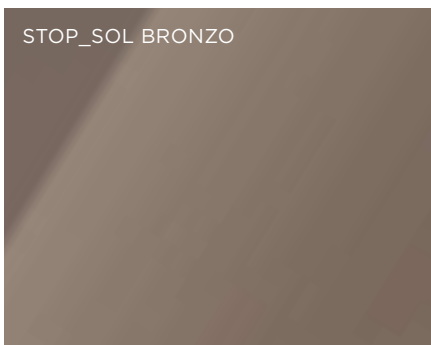

MATERIK  
EXTRACHIARO



SATINATO  
CON ACQUERELLI



TRASPARENTE  
CON ACQUERELLI

ACIDATO 3602



ACIDATO 3604



TRASPARENTE INCISO



SATINATO INCISO

TRASPARENTE SABBIATO

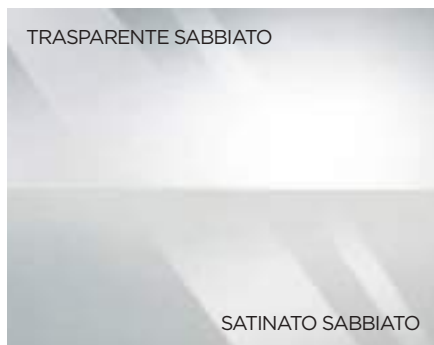

SATINATO SABBIATO

MATERIK 3D  
EXTRACHIARO



MATERIK 3D  
GRIGIO

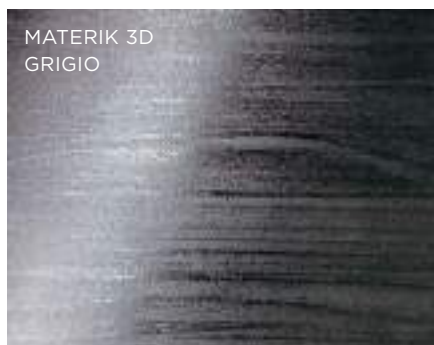

MATERIK 3D  
BRONZO



# MANIGLIE / HANDLES

## ARA / CROMO LUCIDO



ROSETTA/ROSE KUADER standard



ROSETTA/ROSE MINI QUADRA  
PATENT YALE L/O  
su richiesta/on request



CROMO SATINATO



CROMO LUCIDO



OTTONE LUCIDO



NERO OPACO



BIANCO OPACO

DISPONIBILE ANCHE IN VERSIONE DK PER FINESTRA / WINDOW HANDLE ALSO AVAILABLE



## ARYA / CROMO SATINATO



ROSETTA/ROSE KUADER standard



ROSETTA/ROSE MINI QUADRA  
PATENT YALE L/O  
su richiesta/on request



CROMO SATINATO



CROMO LUCIDO



BIANCO OPACO



NERO OPACO



BROWN

 **TRATTAMENTO ANTIBATTERICO** unicamente in cromo satinato su richiesta /  
Antibacterial treatment only on cromo satinato on request

DISPONIBILE ANCHE IN VERSIONE DK PER FINESTRA / WINDOW HANDLE ALSO AVAILABLE



## BALAY / CROMO LUCIDO



ROSETTA/ROSE KUADER standard



ROSETTA/ROSE MINI QUADRA  
PATENT YALE L/O  
su richiesta/on request



CROMO SATINATO



CROMO LUCIDO



BIANCO OPACO



NERO OPACO

DISPONIBILE ANCHE IN VERSIONE DK PER FINESTRA / WINDOW HANDLE ALSO AVAILABLE



## BILBAO / CROMO SATINATO



ROSETTA/ROSE KUADER standard



ROSETTA/ROSE MINI QUADRA  
PATENT YALE L/O  
su richiesta/on request



CROMO LUCIDO



CROMO BICOLORE



OTTONE LUCIDO



NERO OPACO

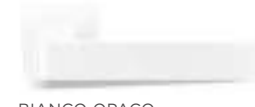

BIANCO OPACO



BROWN

 **TRATTAMENTO ANTIBATTERICO** unicamente in cromo satinato su richiesta /  
Antibacterial treatment only on cromo satinato on request

DISPONIBILE ANCHE IN VERSIONE DK PER FINESTRA / WINDOW HANDLE ALSO AVAILABLE





CAROL / CROMO SATINATO



ROSETTA/ROSE KUADER standard



ROSETTA/ROSE MINI TONDA  
PATENT YALE L/O  
su richiesta/on request

DISPONIBILE ANCHE IN VERSIONE DK PER FINESTRA / WINDOW HANDLE ALSO AVAILABLE



CROMO SATINATO



OTTONE LUCIDO



NERO OPACO



CROMO LUCIDO



BIANCO OPACO

CODA / CROMO LUCIDO



ROSETTA/ROSE KUADER standard



ROSETTA/ROSE MINI QUADRA  
PATENT YALE L/O  
su richiesta/on request

DISPONIBILE ANCHE IN VERSIONE DK PER FINESTRA / WINDOW HANDLE ALSO AVAILABLE



CROMO SATINATO



OTTONE LUCIDO



CROMO LUCIDO



NERO OPACO

DADA / CROMO LUCIDO



ROSETTA/ROSE KUADER standard

DISPONIBILE ANCHE IN VERSIONE DK PER FINESTRA / WINDOW HANDLE ALSO AVAILABLE



CROMO SATINATO



BIANCO OPACO



BROWN



CROMO LUCIDO



NERO OPACO

GENEVE / CROMO SATINATO



ROSETTA/ROSE KUADER standard



ROSETTA/ROSE MINI QUADRA  
PATENT YALE L/O  
su richiesta/on request

DISPONIBILE ANCHE IN VERSIONE DK PER FINESTRA / WINDOW HANDLE ALSO AVAILABLE



CROMO SATINATO



OTTONE LUCIDO



BIANCO OPACO



CROMO LUCIDO



NERO OPACO

# MANIGLIE / HANDLES

## IRON / CROMO LUCIDO



ROSETTA/ROSE KUADER standard



CROMO SATINATO



CROMO LUCIDO



OTTONE LUCIDO



NERO OPACO



BIANCO OPACO



BROWN



TRATTAMENTO ANTIBATTERICO unicamente in cromo satinato su richiesta /  
Antibacterial treatment only on chrome satinato on request



DISPONIBILE ANCHE IN VERSIONE DK PER FINESTRA / WINDOW HANDLE ALSO AVAILABLE

## MONDRIAN / CROMO SATINATO



ROSETTA/ROSE KUADER standard



ROSETTA/ROSE MINI QUADRA  
PATENT YALE L/O  
su richiesta/on request



CROMO SATINATO



CROMO LUCIDO



BIANCO OPACO



NERO OPACO



BROWN



TRATTAMENTO ANTIBATTERICO unicamente in cromo satinato su richiesta /  
Antibacterial treatment only on chrome satinato on request



DISPONIBILE ANCHE IN VERSIONE DK PER FINESTRA / WINDOW HANDLE ALSO AVAILABLE

## NAVY / CROMO LUCIDO



ROSETTA/ROSE KUADER standard



ROSETTA/ROSE MINI QUADRA  
PATENT YALE L/O  
su richiesta/on request



CROMO SATINATO



CROMO LUCIDO



OTTONE LUCIDO



NERO OPACO



BROWN

DISPONIBILE ANCHE IN VERSIONE DK PER FINESTRA / WINDOW HANDLE ALSO AVAILABLE



## PARROT / CROMO LUCIDO



ROSETTA/ROSE KUADER standard



ROSETTA/ROSE MINI QUADRA  
PATENT YALE L/O  
su richiesta/on request



CROMO SATINATO



CROMO BICOLORE



CROMO LUCIDO



OTTONE LUCIDO



OTTONE BICOLORE



NERO OPACO

DISPONIBILE ANCHE IN VERSIONE DK PER FINESTRA / WINDOW HANDLE ALSO AVAILABLE



## PLATA / CROMO SATINATO



ROSETTA/ROSE KUADER standard



CROMO SATINATO



CROMO LUCIDO



BIANCO OPACO



NERO OPACO



TRATTAMENTO ANTIBATTERICO unicamente in cromo satinato su richiesta /  
Antibacterial treatment only on cromo satinato on request

DISPONIBILE ANCHE IN VERSIONE DK PER FINESTRA / WINDOW HANDLE ALSO AVAILABLE



## TIEMPO / CROMO SATINATO



ROSETTA/ROSE KUADER standard



ROSETTA/ROSE MINI QUADRA  
PATENT YALE L/O  
su richiesta/on request



CROMO SATINATO



CROMO LUCIDO



OTTONE LUCIDO



NERO OPACO

DISPONIBILE ANCHE IN VERSIONE DK PER FINESTRA / WINDOW HANDLE ALSO AVAILABLE



## TIEMPO / CROMO SATINATO



ROSETTA/ROSE KUADER standard



ROSETTA/ROSE MINI QUADRA  
PATENT YALE L/O  
su richiesta/on request



CROMO SATINATO



CROMO LUCIDO



OTTONE LUCIDO



NERO OPACO

DISPONIBILE ANCHE IN VERSIONE DK PER FINESTRA / WINDOW HANDLE ALSO AVAILABLE



## TOLEDO / ARGENTO



ROSETTA/ROSE KUADER standard



ARGENTO



BIANCO



BROWN

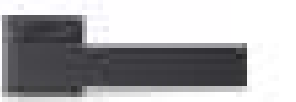

ANTRACITE



TRATTAMENTO ANTIBATTERICO unicamente in cromo satinato su richiesta /  
Antibacterial treatment only on cromo satinato on request

DISPONIBILE ANCHE IN VERSIONE DK PER FINESTRA / WINDOW HANDLE ALSO AVAILABLE



# MANIGLIE / HANDLES

## VERTIGO / CROMO LUCIDO



ROSETTA/ROSE KUADER standard



CROMO SATINATO



CROMO LUCIDO



OTTONE LUCIDO



NERO OPACO



BIANCO OPACO



**TRATTAMENTO ANTIBATTERICO** unicamente in cromo satinato su richiesta /  
Antibacterial treatment only on cromo satinato on request

DISPONIBILE ANCHE IN VERSIONE DK PER FINESTRA / WINDOW HANDLE ALSO AVAILABLE



## VIRGIN / CROMO SATINATO



ROSETTA/ROSE KUADER standard



ROSETTA/ROSE MINI TONDA  
PATENT YALE L/O  
su richiesta/on request



CROMO LUCIDO



CROMO SATINATO



OTTONE LUCIDO



NERO OPACO

DISPONIBILE ANCHE IN VERSIONE DK PER FINESTRA / WINDOW HANDLE ALSO AVAILABLE



## CHEF / CROMO LUCIDO



ROSETTA/ROSE TONDA standard



ROSETTA/ROSE MINI TONDA  
PATENT YALE L/O  
su richiesta/on request



CROMO SATINATO



CROMO LUCIDO

DISPONIBILE ANCHE IN VERSIONE DK PER FINESTRA / WINDOW HANDLE ALSO AVAILABLE



## DEA / CROMO LUCIDO



ROSETTA/ROSE TONDA standard



ROSETTA/ROSE MINI TONDA  
PATENT YALE L/O  
su richiesta/on request



CROMO SATINATO



CROMO LUCIDO



NERO OPACO

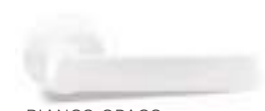

BIANCO OPACO



**TRATTAMENTO ANTIBATTERICO** unicamente in cromo satinato su richiesta /  
Antibacterial treatment only on cromo satinato on request

DISPONIBILE ANCHE IN VERSIONE DK PER FINESTRA / WINDOW HANDLE ALSO AVAILABLE



ELBA / CROMO SATINATO



ROSETTA/ROSE TONDA standard



ROSETTA/ROSE MINI TONDA  
PATENT YALE L/O  
su richiesta/on request



CROMO SATINATO



NERO OPACO

DISPONIBILE ANCHE IN VERSIONE DK PER FINESTRA / WINDOW HANDLE ALSO AVAILABLE



QUARANTUNO / CROMO SATINATO/LUCIDO



ROSETTA/ROSE OVALE standard



CROMO SATINATO/LUCIDO



CROMO SATINATO/NERO OPACO

QUARANTUNO PLUS / NERO/CROMO LUCIDO



ROSETTA/ROSE OVALE standard



NERO/CROMO LUCIDO



NERO/CROMO LUCIDO CON DECORO



NERO/CROMO SATINATO



NERO

STILO 2 / CROMO BICOLORE



ROSETTA/ROSE TONDA standard



ROSETTA/ROSE MINI TONDA  
PATENT YALE L/O  
su richiesta/on request



CROMO BICOLORE

DISPONIBILE ANCHE IN VERSIONE DK PER FINESTRA / WINDOW HANDLE ALSO AVAILABLE



# MANIGLIE / HANDLES

## BASCO / ALLUMINIO CROMO SATINATO



ROSETTA/ROSE KUADER standard



ARGENTO



GOLD



CHAMPAGNE



BRONZE



BROWN



BIANCO OPACO

## MUST / ALLUMINIO CROMO SATINATO



ROSETTA/ROSE KUADER standard



ARGENTO



GOLD



CHAMPAGNE



BRONZE



BROWN



BIANCO OPACO

## SAM / ALLUMINIO CROMO SATINATO



ROSETTA/ROSE KUADER standard



ARGENTO



GOLD



CHAMPAGNE



BRONZE



BROWN



BIANCO OPACO

## TOR / ALLUMINIO CROMO SATINATO



ROSETTA/ROSE KUADER standard



ARGENTO



GOLD



CHAMPAGNE



BRONZE



BROWN



BIANCO OPACO

ALLIE / ALLUMINIO CROMO SATINATO



ARGENTO



GOLD



CHAMPAGNE



BRONZE



BROWN



BIANCO OPACO

SQUARE / ALLUMINIO CROMO SATINATO



ARGENTO



GOLD



CHAMPAGNE



BRONZE



BROWN



BIANCO OPACO

EFFY / ALLUMINIO CROMO SATINATO



ARGENTO



GOLD



CHAMPAGNE



BRONZE



BROWN



BIANCO OPACO

PAC / ALLUMINIO CROMO SATINATO



ARGENTO



GOLD



CHAMPAGNE



BRONZE



BROWN



BIANCO OPACO

# ROSETTE PORTE A BATTENTE / ROSES FOR HINGED DOORS



ROSETTA MINI  
CON BOCCHETTA FORO CHIAVE



ROSETTA TONDA  
CON CHIAVE



ROSETTA KUADER  
CON CHIAVE



ROSETTA MINI  
CON BOCCHETTA FORO YALE



ROSETTA TONDA  
CON YALE



ROSETTA KUADER  
CON YALE



ROSETTA MINI  
CON BOCCHETTA E NOTTOLINO L/O



ROSETTA TONDA  
CON LIBERO/OCCUPATO



ROSETTA KUADER  
CON LIBERO/OCCUPATO

## MANIGLIONI / HANDLES



TODO



LINEAR



POMOLO PASSANTE  
ESTRAIBILE



STYLUS



CODA



TOC  
CROMO SATINATO





KIT UNGHIATA TONDA  
CROMO SATINATO / OTTONE



KIT L/O TONDA  
CROMO SATINATO / OTTONE



KIT UNGHIATA INKA  
CROMO SATINATO



KIT UNGHIATA KUADER  
CROMO SATINATO



KIT L/O KUADER  
CROMO SATINATO



KIT UNGHIATA BIG  
CROMO SATINATO



MANIGLIA SLIDE  
CROMO SATINATO



MANIGLIA FAT



C-LARGE  
C-SMALL

## FERMAPORTA / DOORSTOPS

Nella gamma di accessori fermaporta da montare a pavimento: 5 diversi design e 4 finiture, da abbinare alle maniglie e all'ambiente. / In our range of accessories we also offer doorstops to be installed on the floor: 5 different design pieces in 4 finishes to match with handles and surroundings.



LANCIA



VERSO



CASCO



CONO



BOX

# CERNIERE E SERRATURE / HINGES AND LOCKS



CERNIERE A SCOMPARSA  
REGOLABILI FILOMURO  
TAMBURATE



CERNIERE FILOMURO  
ALASKA



CERNIERE A SCOMPARSA  
REGOLABILI FILOMURO  
CRYSTAL, CRYSTAL BI



CHIUSURA CON  
TIRO MAGNETE



SERRATURA  
MAGNETICA



SERRATURA  
CRYSTAL



SERRATURA  
ALASKA



MAGNETICA  
CON CHIAVE

MAGNETICA  
CON YALE

MAGNETICA CON  
LIBERO OCCUPATO

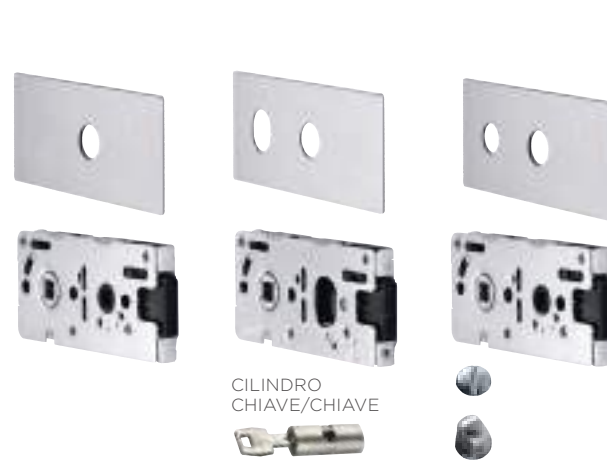

MAGNETICA  
ALASKA

MAGNETICA  
CON YALE  
ALASKA

MAGNETICA CON  
LIBERO OCCUPATO  
ALASKA



SCIVOLA T SERRATURA  
Scorrevole a scomparsa  
Anta legno



SERRATURA  
Scorrevole a scomparsa  
Alaska



Compliant

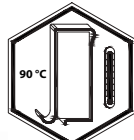



Con la verniciatura all'acqua  
rispettiamo l'ambiente e te,  
lo dicono le nostre certificazioni.

OUR WATER BASED PAINTS RESPECT YOU AND THE ENVIRONMENT,  
OUR CERTIFICATES PROVE IT.



## GREEN CONCEPT



BERTOLOTTO GREEN: attraverso i suoi prodotti, semilavorati, materie prime, processi produttivi e autoproducendo energia elettrica e termica mediante innovativi impianti fotovoltaici e una centrale a biomassa, l'azienda si impegna a minimizzare l'impatto ambientale. / BERTOLOTTO GREEN: the company is committed to minimizing its environmental impact through its manufacturing processes and use of raw materials. The manufacturing processes are powered with electrical and thermal energy provided by photovoltaic power systems and a biomass thermal power plant.



Il Forest Stewardship Council® è un'organizzazione internazionale non governativa che promuove una gestione delle foreste del mondo ambientalmente adeguata, socialmente utile ed economicamente sostenibile. Per saperne di più, visita il sito [www.fsc.org](http://www.fsc.org). Prodotti certificati FSC® \*disponibili su richiesta. / Forest Stewardship Council® is a non-governmental organization which promotes an environmentally appropriate, socially responsible and economically sustainable world forest management. For further information, visit [www.fsc.org](http://www.fsc.org). Certified FSC® \*products are available on demand.



Le nostre materie prime legnose sono certificate CARB. La certificazione CARB, acronimo di California Air Resource Board, è basata sul regolamento Airborne Toxic Control Measure (ATCM) la cui finalità è di ridurre e controllare le emissioni di formaldeide dai materiali a base legno. / Our wood-based raw materials obtained CARB certification. The CARB certification, which stands for California Air Resource Board, is based on the Airborne Toxic Control Measure regulation (ATCM) whose purpose is to reduce and control the emissions of formaldehyde from wood-based.



Compliant

Il LEED® (Leadership in Energy and Environmental Design) Green Building Rating System è uno standard internazionale volontario, in continua evoluzione e basato sul consenso e ha l'obiettivo di promuovere lo sviluppo di edifici sostenibili ad alte prestazioni, utilizzando un sistema a punti. Il programma di certificazione LEED® è stato avviato dall'USGBC (US Green Building Council) ed è riconosciuto a livello internazionale. I prodotti "Effetto Legno" Bertolotto sono in compliance con il credito Low Emitting Materials. / LEED® (Leadership in Energy and Environmental Design) Green Building Rating System is a worldwide certification programme developed by the US Green Building Council which aims to promote the development of high performance green buildings through a ratings system. Bertolotto "Effetto Legno" products are in compliance with the credit for Low Emitting Materials.



VOC Emission Test Report Indoor Air Comfort Gold. I prodotti finiti Bertolotto sono realizzati con materiali, finiture e laccature che rispettano i requisiti VOC, riducendo al massimo i composti organici volatili dannosi per la salute e l'ambiente. Questo certificato permette di ottenere i crediti per il sistema di certificazione LEED® (Leadership in Energy and Environmental Design). / VOC Emission Test Report Indoor Air Comfort Gold. Bertolotto's products are made of material, finishes and lacquers that respect VOC standards, by minimizing the volatile organic compounds which are dangerous for health and the environment. This certificate provides credits for the LEED® (Leadership in Energy and Environmental Design) ratings system.



La collezione Effetto Legno e le porte laccate delle collezioni Bertolotto presentano porte con trattamento antibatterico NO-GERMS® grazie a una tecnologia microbiologicamente testata secondo la normativa ISO 22196:2011, ne riduce entro le 24 ore la carica batterica fino al 99,9%. / The Effetto Legno collection and the lacquered doors of the Bertolotto collections can provide doors with NO-GERM® antibacterial treatment which, thanks to a technology that is microbiologically tested in accordance with ISO 22196:2011, reduces its bacterial load by up to 99,9% within 24 hours.



Bertolotto garantisce una resistenza di tenuta da incollaggio dei bordi di battuta quadra e squadrata da 4 decimi e quadra da 8 decimi fino a 90°C. / Bertolotto guarantees a bonding glue resistance of the four tenths and eight tenths squared rabbet corners of 90°C.

## SISTEMI DI GESTIONE / MANAGEMENT SYSTEMS



Sistema di gestione integrato ISO 14001/9001/45001  
Ambiente/Qualità/Sicurezza.  
ISO 14001/9001/45001 integrated management system  
Environment/Quality/Safety

## CERTIFICATI / CERTIFICATES

Bertolotto ha intrapreso un iter di certificazioni sempre in crescita, sui sistemi di prodotto, finiture, analisi chimico-fisiche dei materiali. R&S Bertolotto sta ampliando la gamma di certificati di porte tagliafuoco secondo le attuali normative Europee EN 1634-1, di tenuta fumi freddi SA e fumi caldi SM-200, di abbattimento acustico presso i principali laboratori italiani certificati. / Bertolotto has undertaken a certification procedure which is constantly evolving, on product systems, finishes and the physical-chemical analysis of materials. R&D Bertolotto is widening its range of certificates for fireproof doors in line with current European regulations. EN 1634-1, against 'cold smoke' SA and hot smoke SM-200, and for soundproofing with the most recognised Italian laboratories.

DESCRIZIONE DESCRIPTION	NORMATIVA LEGISLATION	ANALISI SU ANALYSYS ON	RISULTATO RESULT
Resistenza della superficie al graffio / Scratchproof surface	UNI EN 15186:2012	Anta finitura effetto legno Bertolotto Grafite / Door Finish: Effetto Legno Bertolotto Grafite	CARICO di esercizio 2.2N - CLASSE RAGGIUNTA B- (VALORE MEDIO TRA A/B/C) / SCRATCH LOAD 2.2N STANDARD ACHIEVED: B - (middle score between A/B/C)
Resistenza apertura e chiusura ripetuta / Resistance to repeated opening and closing	EN 1191:2012	AIR su anta tamburata / AIR on a honeycomb core door	100.000 CICLI ESEGUITI - TEST SUPERATO CON CAMPIONE ANCORA CONFORME / 100.000 CYCLES CARRIED OUT - Test passed with the sample still in compliance with regulations
Resistenza a cicli umido-secco / Resistance to damp/dry cycles	PTP 25 Del 2016 Rev 3. CATAS	Anta melaminica Effetto legno Bertolotto / Anta melaminica Effetto legno Bertolotto	Start test temperatura 23°con UR 90% durata prova 30gg: NON si evidenziano rigonfiamenti dei listelli strutturali interni. Test eseguito su pannelli della concorrenza su pannelli della concorrenza con risultato di quest'ultimo non positivo dopo 10 gg / Start test temperature 23°with RH 90% trial lasting 30 days: NO warping was revealed in the internal wooden structure. Test carried out on panels from competitors with the latter showing signs of warping after 10 days
Rigonfiamento dopo 24 ore di immersione in acqua su telaio Materik / Swelling after 24 H of being immersed in water on the Materik frame	EN 317:2013	TKT	Valore medio in percentuale di rigonfiamento 7,2% / Average percent of swelling 7.2%
Analisi Infrarossi / Infrared analysis	ASTM E 1252:2013	Carta melaminica / Melamine card	Risultato dello spettro infrarosso indica la presenza prevalente di tipo acrilico pertanto il campione risulta laccato / Results of the infrared spectrum indicates a predominant presence of acrylic, therefore the sample results as lacquered
Prova di usura mediante sfregamento / Friction wear test	PTP CATAS	Test su superficie laccata / Test on lacquered surface	Strofinamento di tampone feltro di lana, massa areica 78 gr/mq, forza esercitata di 2N, con frequenza di scorrimento di 43 cicli al minuto. Dopo 50.000 cicli non si riscontrano difetti / Rubbing with a wool felt swab, areic mass 78gr/mq, force exerted 2N, with a rubbing frequency of 43 cycles per minute. After 50.000 cycles no defects were found
Determinazione del rilascio di formaldeide - Parte 3 / Formaldehyde emissions test - Parte 3	EN ISO 12460-3:2015	Anta melaminica liscia / Smooth melamine door	Risultato della Prova mgHCHO/(m2h)= 0,3 / Test results mgHCHO/(m2h) = 0,3
Determinazione del rilascio di formaldeide - Parte 3 / Formaldehyde emissions test - Parte 3	EN ISO 12460-3:2015	Anta melaminica Effetto legno Materik / Effetto Legno melamine door Materik	Risultato della Prova mgHCHO/(m2h)= 0,3 / Test results mgHCHO/(m2h) = 0,3
Determinazione del rilascio di formaldeide - Parte 3 / Formaldehyde emissions test - Parte 3	EN ISO 12460-3:2015	Anta primer Filomuro / Filomuro Primer Paintable door	Risultato della Prova mgHCHO/(m2h)= 0,3 / Test results mgHCHO/(m2h) = 0,3
Determinazione del rilascio di formaldeide - Parte 3 / Formaldehyde emissions test - Parte 3	EN ISO 12460-3:2015	Anta MDF 8mm / Door MDF 8mm	Risultato della Prova mgHCHO/(m2h)= 2,9 / Test results mgHCHO/(m2h) = 2,9
Determinazione del rilascio di formaldeide - Parte 3 / Formaldehyde emissions test - Parte 3	EN ISO 12460-3:2015	Anta MDF 5mm / Door MDF 5mm	Risultato della Prova mgHCHO/(m2h)= 2,2 / Test results mgHCHO/(m2h) = 2,2

# CERTIFICATI / CERTIFICATES

DESCRIZIONE DESCRIPTION	NORMATIVA LEGISLATION	ANALISI SU ANALYSYS ON	RISULTATO RESULT
Resistenza alla graffiatura / Scratch resistance	UNI 9248:1989	Microlaminato Bianco / Microlaminated Bianco	Con carico 0,6N= livello prova raggiunto 3 con scala da 1(min) a 5(max) / Load 0,6N = test level achieved 3 on a scale of 1 (min) to 5 (max)
Resistenza alla graffiatura / Scratch resistance	UNI 9248:1989	Anta melaminica / Melamine door	Con carico 4,5N= livello prova raggiunto 5 con scala da 1(min) a 5(max) / Load 4,5N = test level achieved 5 on a scale of 1 (min) to 5 (max)
Resistenza alla graffiatura / Scratch resistance	UNI 9248:1989	Anta melaminica Effetto legno Materik / Melamine Effetto Legno door Materik	Con carico 4,5N= livello prova raggiunto 5 con scala da 1(min) a 5(max) / Load 4,5N = test level achieved: 5 on a scale of 1 (min) to 5 (max)
Resistenza delle superfici liquidi freddi - PTP 53 REV.1 / Surface resistance to cold liquids - PTP 53 REV.1	UNI EN 12720:2011	Anta laccata Bertolotto / Anta laccata Bertolotto	Prova 16H contatto con prodotto 1: CIF GEL CANDEGGINA valore 4 (lieve cambiamento visibile solo con luce riflessa) / Test 16H of contact with product 1: CIF GEL CANDEGGINA result 4 (slight change only visible under reflected light)
Resistenza delle superfici liquidi freddi - PTP 53 REV.1 / Surface resistance to cold liquids - PTP 53 REV.1	UNI EN 12720:2011	Anta laccata Bertolotto / Bertolotto lacquered door	Prova 16H contatto con prodotto 2: CIF SPRAY ATTIVO CON CANDEGGINA valore 5 (nessun cambiamento) / Test 16H of contact with product 2: CIF SPRAY ATTIVO CON CANDEGGINA result 5 (no change)
Resistenza delle superfici liquidi freddi - PTP 53 REV.1 / Surface resistance to cold liquids - PTP 53 REV.1	UNI EN 12720:2011	Anta laccata Bertolotto / Bertolotto lacquered door	Prova 16H contatto con prodotto 3: CILLIT BANG CALCARE valore 4 (lieve cambiamento visibile solo con luce riflessa) / Test 16H of contact with product 3: CILLIT BANG CALCARE result 4 (slight change only visible under reflected light)
Resistenza delle superfici liquidi freddi - PTP 53 REV.1 / Surface resistance to cold liquids - PTP 53 REV.1	UNI EN 12720:2011	Anta laccata Bertolotto / Bertolotto lacquered door	Prova 16H contatto con prodotto 4: CIF POWER CREAM CUCINA valore valore 4 (lieve cambiamento visibile solo con luce riflessa) / Prova 16H of contact with product 4: CIF POWER CREAM CUCINA result 4 (slight change only visible under reflected light)
Resistenza delle superfici liquidi freddi - PTP 53 REV.1 / Surface resistance to cold liquids - PTP 53 REV.1	UNI EN 12720:2011	Anta Tranciato / Tranciato door	Prova 16H contatto con prodotto 1: CIF GEL CANDEGGINA valore 5 (nessun cambiamento) / Test 16H of contact with product 1: CIF GEL CANDEGGINA result 5 (no change).
Resistenza delle superfici liquidi freddi - PTP 53 REV.1 / Surface resistance to cold liquids - PTP 53 REV.1	UNI EN 12720:2011	Anta Tranciato / Tranciato door	Prova 16H contatto con prodotto 2: CIF SPRAY ATTIVO CON CANDEGGINA valore 5 (nessun cambiamento) / Test 16H of contact with product 2: CIF SPRAY ATTIVO CON CANDEGGINA result 5 (no change)
Resistenza delle superfici liquidi freddi - PTP 53 REV.1 / Surface resistance to cold liquids - PTP 53 REV.1	UNI EN 12720:2011	Anta Tranciato / Tranciato door	Prova 16H contatto con prodotto 3: CILLIT BANG CALCARE valore 5 (nessun cambiamento) / Test 16H of contact with product 3: CILLIT BANG CALCARE result 5 (no change)
Resistenza delle superfici liquidi freddi - PTP 53 REV.1 / Surface resistance to cold liquids - PTP 53 REV.1	UNI EN 12720:2011	Anta Tranciato / Tranciato door	Prova 16H contatto con prodotto 4: CIF POWER CREAM CUCINA valore 5 (nessun cambiamento) / Test 16H of contact with product 4: CIF POWER CREAM CUCINA result 5 (no change)



DESCRIZIONE DESCRIPTION	NORMATIVA LEGISLATION	ANALISI SU ANALYSYS ON	RISULTATO RESULT
Resistenza delle superfici liquidi freddi (prodotti di pulizia) / Surface resistance to cold liquids (cleaning products)	EN 12720: 2013	Test su laccato / Test on lacquered doors	Acido acatico (16H=5) - Acetone (16H=2)- Ammoniaca (16H=4) - Vino rosso (16H=3)- Acido citrico (16H=5) - Soluzione detergente (16H=5)- Caè (16H=3) - Cloramina (16H=5)- Inchiostro per timbri (16H=2) - Etanolo (16H=3) - Etile butile acetato (16H=2) - Olio di oliva (16H=5) - Olio di Paraffina (16H=5) - Carbonato di sodio (16H=5) - Cloruro di sodio (16H=5) - Te (16H=4) - Acqua distillata (16H=5) - Birra chiara (16H=5) - le sostanze ed i tempi sono quelli previsti dalla norma UNI 10944: 2001 CLASSE RAGGIUNTA secondo UNI 10964 = D / Acetic Acid (16H=5) - Acetone (16H=2) - Ammonia (16H=4) - Red wine (16H=3) - Citric acid (16H=5) - Detergent (16H=5) - Coffee (16H=3) - Chloramine (16H=5) - Ink for rubber stamps (16H=2) - Ethanol (16H=3) - Ethyl butyl acetate (16H=2) - Olive oil (16H=5) - Paraffin oil (16H=5) - Carbonate of soda (16H=5) - Sodium chloride (16H=5) - Te (16H=4) - Distilled water (16H=5) - Lager (16H=5) - The substances and times are those provided by legislation UNI 10944: 2001 Standard achieved according to UNI 10964 = D
Resistenza agli sbalzi di temperatura / Resistance to jumps in temperature	UNI 9429:89	Test su primer Filomuro / Test on Filomuro Primer Paintable	Risultato = valore 5. Osservazione dopo 15 cicli non si riscontrano difetti / Result = level 5. Observation after 15 cycles no defects found
Resistenza alla trazione su telaio LSB / Tensile strength on the LSB frame	PROCEDURA CATAS	LSB 3 strati (10/30/10mm) / LSB 3 layers (10/30/10mm)	1.199 N = Risultato ottimale / 1.199 N = Excellent result
Massa volumica in riferimento alla norma EN 323:1993 / Density in reference to legislation EN 323:1993	EN 323:1993	MDF IDRO CARB FSC 11,7mm	Risultato analisi 779Kg/mc / Analysis result 779Kg/mc
Rigonfiamento dopo 24H di immersione in acqua / Swelling after 24H of immersion in water	EN 317:1993	MDF IDRO CARB FSC 11,7mm	Valore medio in percentuale di rigonfiamento 7,7% / Average percentage of swelling 7,7%
Massa volumica in riferimento alla norma EN 323:1993 / Density in reference to legislation EN 323:1993	EN 323:1993	MDF IDRO CARB FSC 9,7mm	Risultato analisi 704Kg/mc / Analysis result 704Kg/mc
Rigonfiamento dopo 24H di immersione in acqua / Swelling after 24H of immersion in water	EN 317:1993	MDF IDRO CARB FSC 9,7mm	Valore medio in percentuale di rigonfiamento 3,6% / Average percentage of swelling 3,6%
Massa volumica in riferimento alla norma EN 323:1993 / Density in reference to legislation EN 323:1993	EN 323:1993	MDF IDRO CARB FSC 40mm	Risultato analisi 673Kg/mc / Analysis result 673Kg/mc
Rigonfiamento dopo 24H di immersione in acqua / Swelling after 24H of immersion in water	EN 317:1993	MDF IDRO CARB FSC 9,7mm	Valore medio in percentuale di rigonfiamento 2,2% / Average percentage of swelling 2,2%
Massa volumica in riferimento alla norma EN 323:1993 / Density in reference to legislation EN 323:1993	EN 323:1993	MDF IDRO CARB FSC 9,7mm	Risultato analisi 800Kg/mc / Analysis result 800Kg/mc
Rigonfiamento dopo 24H di immersione in acqua / Swelling after 24H of immersion in water	EN 323:1993	MDF IDRO CARB FSC 9,7mm	Valore medio in percentuale di rigonfiamento 10,5% / Average percentage of swelling 10,5%

## CERTIFICATI / CERTIFICATES

Certificazione acustica presso il laboratorio CSI per la porta tamburata allestita con guarnizione acustica di serie, reticolare acustico e soglia acustica NO SOUND, valore 29 dB. / Soundproofing certificate from the CSI laboratory for honeycomb core doors with standard acoustic seal, RETICOLARE ACOUSTICA and acoustic doorstep NO SOUND, level 29 dB.

Certificazione acustica presso il laboratorio CSI per la porta tamburata allestita con guarnizione acustica di serie, truciolare di lino pieno e soglia acustica NO SOUND, valore 29 dB. / Soundproofing certificate from the CSI laboratory for honeycomb core doors with standard acoustic seal, TRUCIOLARE DI LINO PIENO and NO SOUND acoustic doorstep, level 29 dB.

Test di tenuta meccanica/incollaggio dell'aletta folding dei coprifili Bertolotto con diametro INSTRON5585 presso CATAS. Risultato del test: 487 N come carico max alla rottura. Valore esponenzialmente superiore a quello della tradizionale aletta incollata, che garantisce la quasi impossibilità di rottura nel trasporto o durante l'installazione. / Test of mechanical and adhesive hold on the folding wing of Bertolotto trims with an INSTRON 5585 spring scale at CATAS. Test results: 487 N as maximum load to breaking. A exponentially superior result compared to the traditional glued wing, which guarantees it is almost impossible to break during transport and installation.

Cicli di apertura testati su cerniera AIR 120° - 180° - Durabilità meccanica e forze di manovra - UNI EN 1191:2013 12046-2:2002. Abbiamo ottenuto 200.000 cicli eseguiti - TEST superato ancora conforme dopo stress sistema. / AIR Glass leaf analysis of opening cycles - Mechanical durability and operating force - UNI EN 1191:2013 12046-2:2002. We reached 200.000 cycles executed - TEST passed and still in compliance after stress on the system.

## LABORATORI / LABORATORIES



## 96 BREVETTI / 96 PATENTS



Bertolotto Porte ad oggi ha registrato 96 brevetti internazionali sia di design, Patent Pending, sia di nuovi sistemi di ferramenta e soluzioni tecniche innovative. Bertolotto Porte identifica l'originalità e la qualità del proprio design attraverso 61 Marchi Registrati. / To date Bertolotto Porte has filed 96 international patents for design, Patent Pending, new hardware systems and innovative technical solutions; Bertolotto has identified its originality and the quality of its designs through 61 Registered Trademarks.

## SOSTENIBILITÀ

Ci impegniamo a salvaguardare il nostro pianeta, contribuendo alla costruzione di un futuro sostenibile. Vogliamo crescere in modo consapevole, con costanza, perché evolversi significa produrre vantaggi anche per l'ambiente, attraverso processi produttivi responsabili e accorti.

## SALUTE E SICUREZZA

Ci impegniamo a prenderci cura di chi lavora; la sicurezza dei nostri dipendenti è lo specchio della nostra volontà di essere un'azienda attenta al benessere, a partire da chi ne è parte integrante. La condivisione e il contributo di ognuno sono il fondamento su cui si costruiscono i successi, ecco perché riteniamo indispensabile un ambiente salubre dove concretizzare insieme i nostri progetti.

## RESPONSABILITÀ

Ci impegniamo a garantire in modo continuativo la qualità dei nostri servizi, operando nel rispetto di canoni etici e comportamentali. Le tante certificazioni ottenute attestano il continuo miglioramento dei processi produttivi aziendali e la riduzione degli impatti ambientali. Facciamo un uso attento delle risorse e la maggior parte del legno che utilizziamo proviene da foreste gestite in modo responsabile; ciò significa garantire un prodotto che non è stato creato a spese della foresta o degli animali, delle piante e delle persone che ci vivono. Abbattimento acustico e resistenza al fuoco caratterizzano una parte dei nostri prodotti; selezioniamo le migliori materie prime e semilavorati, a bassa emissione di formaldeide e se possibile idrofughi. Per ridurre le emissioni in atmosfera abbiamo in sede una centrale termica a biomassa che riscalda l'intero stabilimento e grazie a un impianto fotovoltaico riusciamo a ridurre l'immissione di CO<sub>2</sub> nell'atmosfera. Per noi di Bertolotto il rispetto a 360 gradi è basilare e continuerà a guidarci nelle nostre scelte.

## SUSTAINABILITY

We are committed to safeguarding our planet, working to build a sustainable future. We want to grow with constant awareness, using responsible manufacturing processes that are advantageous for the environment.

## HEALTH AND SAFETY

We are committed to taking care of those who work; our employees' safety reflects our desire to be concerned about well-being, starting from those who form an integral part of our company. Sharing and contribution are the foundation upon which success grows, this is why we believe it is crucial to provide a healthy environment in which we can achieve our goals together.

## RESPONSIBILITY

We always strive to ensure the quality of our services, working in accordance with ethical and behavioural standards. The numerous certificates we have been given testify to our commitment to constantly improving our manufacturing processes and reducing our impact on the environment. We use resources carefully and the majority of the wood we use comes from sustainably managed forests; this means guaranteeing a product which was not manufactured at the expense of the forest, the animals, the plants or people who live there. Noise reduction and fire resistance characterize part of our products; we select the best raw materials and semi-finished products, with low formaldehyde emissions and, whenever possible, water-repellent. In our headquarters we have installed a biomass thermal power plant that heats the entire establishment and thanks to our solar power system we have managed to reduce CO<sub>2</sub> emissions into the atmosphere. At Bertolotto respect is fundamental in all of its forms and it will continue to lead us in our choices.



**BERTOLOTTO**<sup>®</sup>  
  **PORTE**

## SISTEMI FILOMURO

I edizione / 1<sup>st</sup> edition

Bertolotto S.p.A. si riserva il diritto di apportare, senza preavviso, ogni modifica volta al miglioramento funzionale e qualitativo dei prodotti. Le informazioni e i disegni rappresentati in questo catalogo, oltre ad avere carattere puramente illustrativo, sono suscettibili di variazioni. I campioni di colori e materiali presentati in questo stampato hanno un valore indicativo compatibilmente con i limiti di riproduzione e stampa.

© PROPRIETÀ DI Bertolotto S.p.A. - TUTTI I DIRITTI RISERVATI - I marchi e gli altri segni distintivi, i testi, le fotografie, i disegni e i modelli, i prodotti e gli altri materiali riportati nella presente brochure e tutti i diritti di proprietà intellettuale e industriale a essi relativi costituiscono proprietà riservata di Bertolotto S.p.A. È vietata la riproduzione, copia, imitazione, pubblicazione, diffusione, distribuzione, elaborazione e qualsiasi uso, anche parziale, nella pubblicità, su prodotti, confezioni, materiali illustrativi o pubblicitari, siti internet, nelle attività di marketing e commerciali e ogni altro uso, senza preventiva autorizzazione scritta di Bertolotto S.p.A.

Bertolotto S.p.A. We reserve the right to change, without notice, any modification to the functional improvement and quality of our products. The information and drawings in this catalogue, besides being of a purely illustrative nature, may be subject to change. Samples of colors and materials presented in this publication are indicative, consistent with the limitations of reproduction and printing.

© PROPERTIES OF Bertolotto S.p.A. - ALL RIGHTS RESERVED - Trademarks and other distinctive signs, texts, photographs, drawings and models, products and other materials contained in this brochure and all the intellectual and industrial property rights relating thereto are copyrighted by Bertolotto S.p.A. Their reproduction, copying, imitation, publication, dissemination, distribution, processing and use, even partial, for advertising, products, packaging, artworks or advertising, websites, marketing activities and sales and all other use is strictly forbidden without the prior written permission of Bertolotto S.p.A.





BERTOLOTTO S.p.A.  
CIRCONVALLAZIONE G. GIOLITTI, 43/45  
12030 TORRE S. GIORGIO (CN) ITALY  
TEL. +39.0172.91.28 - FAX +39.0172.912.800  
[www.bertolotto.com](http://www.bertolotto.com) - [staff@bertolotto.com](mailto:staff@bertolotto.com)

I edizione / Dicembre 2020  
Collana cataloghi Sistemi Filomuro 2021