

**PIGRECO**

**MARTEX**

# PIGRECO

design mario mazzer

“When we think about the office,  
we think about people who work there”

# “La Piazza” office - Pigreco

en\_If Nucleo in “La PIAZZA” represents the point of aggregation and relationship, Pigreco responds to the operative needs that gravitate around “La PIAZZA”. Private offices, working areas and meeting rooms are furnished to satisfy all the needs of those who live there. Presented also in the Loop leg version, Pigreco responds to aesthetic and functional needs but above all to well-being in the office.

it\_Se Nucleo nella PIAZZA rappresenta il punto di aggregazione e di relazione, Pigreco risponde alle necessità operative che gravitano attorno. Uffici privati, aree operative e sale riunioni sono arredate soddisfacendo tutte le necessità di chi le abita. Presentato anche nella versione gamba Loop, Pigreco risponde ad esigenze estetiche e funzionali ma soprattutto di benessere in ufficio.

fr\_Si Nucleo représente dans “La PIAZZA” le point d’agrégation et de relation, Pigreco répond aux besoins opérationnels qui gravitent autour “La PIAZZA”. Les bureaux privés, les zones opérationnelles et les salles de réunion sont aménagés pour répondre à tous les besoins de ceux qui y vivent. Présenté également dans la version pied fermé (Loop), Pigreco répond aux besoins esthétiques et fonctionnels mais surtout au bien-être des lieux de travail.

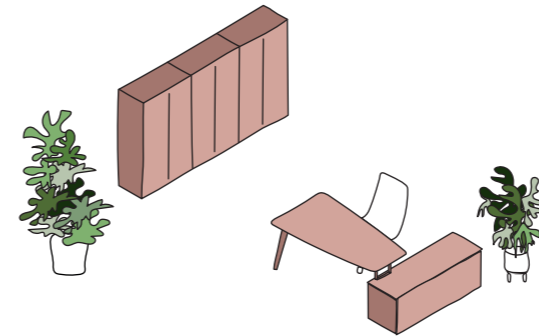
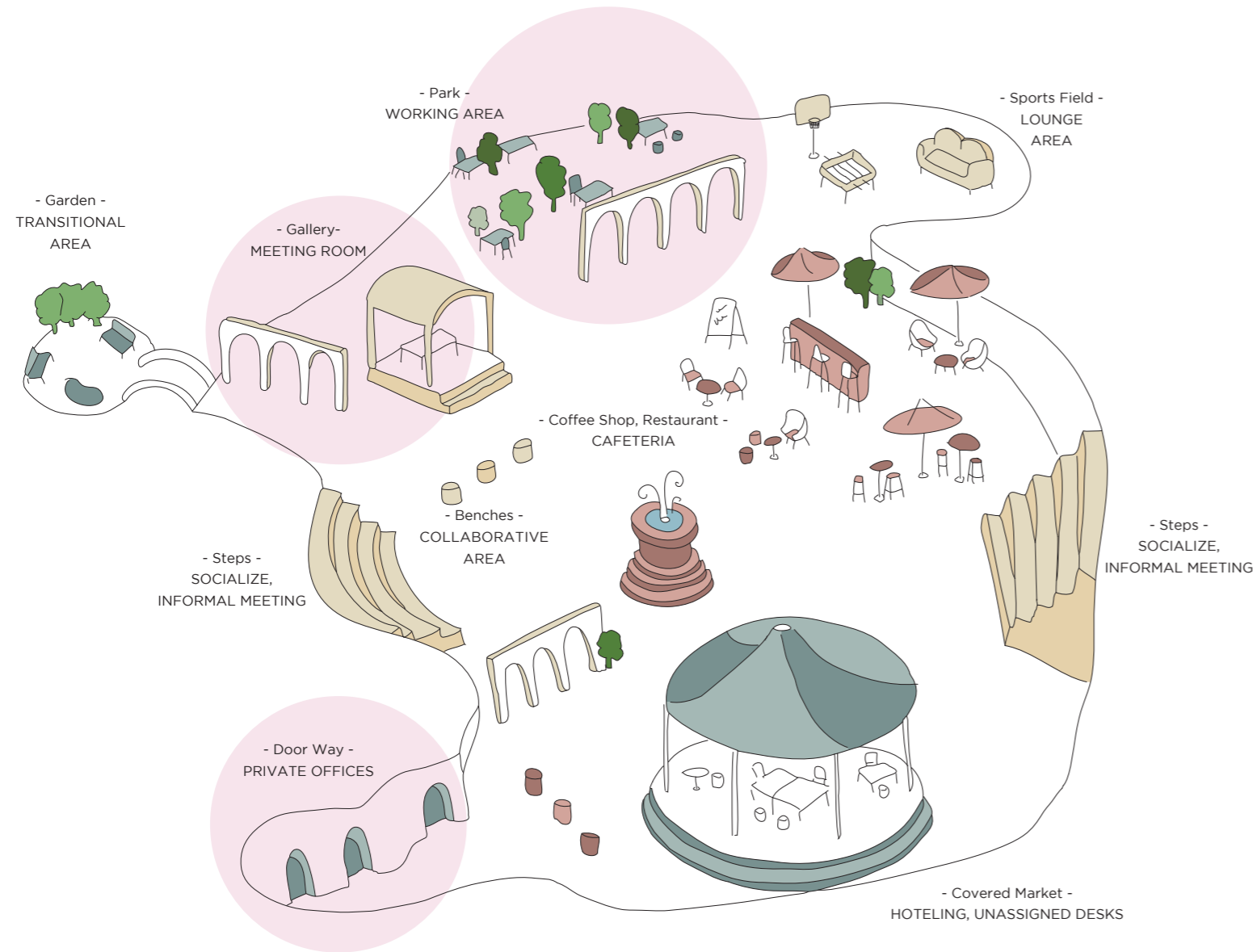

## Door Way - Private Office

en\_The new workflows that characterize our society, such as integration, synergy and communication management, have suggested new managers to operate in workplaces that allow the development of relations and connections, abandoning thus, the strict separation of space and functions.

it\_I nuovi flussi di lavoro che contraddistinguono la nostra società, hanno suggerito ai nuovi manager di operare in luoghi di lavoro che consentono lo sviluppo delle relazioni e della connessione, rinunciando così, alla rigida separazione dello spazio e delle funzioni.

fr\_Les nouveaux flux de travail qui caractérisent notre société ont suggéré aux nouveaux dirigeants de travailler dans des lieux qui permettent le développement des relations et connexions, renonçant ainsi à la rigide séparation de l'espace et des fonctions.

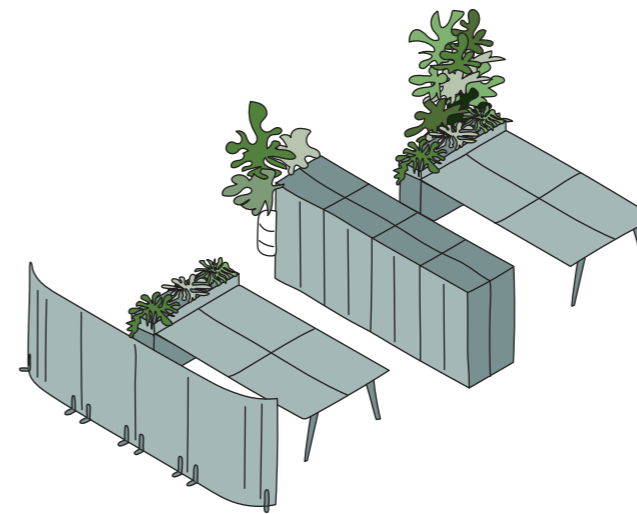

## Park - Working area

en\_The operative area is the heart of the company and the place where employees work both independently and collaborating with each other; for this reason they need functional and comfortable workstations that allow them to concentrate but also to dialogue and confront each other.

it\_L'area operativa è il cuore dell'azienda e il luogo dove i dipendenti lavorano sia in maniera autonoma, sia collaborando tra loro; per questo motivo hanno bisogno di postazioni funzionali e confortevoli che permettano loro di concentrarsi, ma anche di dialogare e confrontarsi.

fr\_L'espace de travail est le cœur de l'usine et l'endroit où les employés travaillent soit de manière autonome soit en collaborant en équipe; pour ce motif ils ont besoin de postes de travaux fonctionnels et confortables qui permettent de se concentrer mais aussi de dialoguer et se mesurer.



## Gallery - Meeting room

en\_Meeting rooms can be sorted into small or large rooms: the first ones allow to organize in private and informal meetings between few people and require compact tables with simple electrification; the large one are wider spaces and make the conversations more formal and important.

it\_Le sale riunioni si possono dividere in sale di piccole o grandi dimensioni: le prime permettono di organizzarsi in incontri privati ed informali tra poche persone e richiedono tavoli compatti con una semplice elettrificazione; le altre, essendo più ampie, rendono le conversazioni più formali e importanti.

fr\_Les salles de réunion peuvent se diviser en petites ou grandes: les premières permettent de s'organiser en rencontres privées et informels entre peu gens et demandent tables compactes avec une électrification simple; les autres en étant plus amplie rendent les conversations plus formelles et importantes.

## Central beam allows a total span of 3600 mm

en\_Metal structure composed by a single central beam that allows a total span of 3600 mm without any central supporting element. The base of the central beam provides support of the wire basket and frontal screens leaving the composition clean and essential.

it\_Struttura composta da un'unica trave metallica centrale che permette campate fino a 3600 mm senza supporto centrale. La base della trave centrale costituisce l'elemento di supporto per vaschette porta cavi e screen frontali, lasciando la composizione pulita ed essenziale.

fr\_Structure composée par une poutre métallique centrale unique qui permet une portée totale de 3600 mm sans aucune élément de support central. La base de la poutre centrale fournit un support pour les bacs passe-câbles et les cloisonnettes frontaux, laissant la composition sobre et essentielle.



# Around “La Piazza” - Martex

en\_In a city the town square represents the focal point of social life, a melting pot of exchange and interaction. Pigreco range adapts to the needs that circle around “La Piazza”.

it\_In una città la piazza rappresenta il punto focale della vita sociale, un crogiuolo di scambi e interazioni. La gamma Pigreco si adatta alle esigenze che ruotano attorno a “La Piazza”.

fr\_Dans une ville, la place représente le point focal de la vie sociale, un point de rencontre pour l'échange et l'interaction. La gamme Pigreco est capable de satisfaire les besoins qui tournent autour de “La Piazza”.







en\_Bench 4 pax W. 3600 D. 1600 mm without central support, white tops with scallop, wooden leg and Nucleo screen in Fabric Cat. L 722 Monument.

it\_Bench 4 posti L. 3600 P. 1600 mm senza gamba intermedia elettrificata, piani bianchi con scaloppa, gamba legno e screen Nucleo tessuto Cat. L 722 Monument.

fr\_Bench 4 places L. 3600 P. 1600 mm sans pied intermédiaire électrifié, plateaux blancs avec échancrure, pied en bois et cloisonnette Nucleo en tissu Cat. L 722 Monument.







en\_The interconnected Nucleo freestanding panels can create modular meeting rooms in the open spaces.  
In this picture the internal space available is W. 3100 mm  
D. 3900 mm. Nucleo freestanding panels external Cat. H 990 Verde Scuro, internal Cat. L 722 Monument.

it\_I pannelli freestanding Nucleo connessi tra loro possono creare delle sale riunioni modulabili all'interno degli open space.  
In questa immagine lo spazio interno a disposizione è L. 3100 mm  
P. 3900 mm. Pannelli Nucleo esterno Cat. H 990 Verde Scuro, interno Cat. L 722 Monument.

fr\_Les panneaux autoportants Nucleo connectés peuvent créer des salles de réunion modulaires à l'intérieur des espaces ouverts.  
Dans cette image, l'espace interne disponible est de L. 3100 mm  
P. 3900 mm. Panneaux externe Cat. H 990 Verde Scuro, interne Cat. L 722 Monument.





en\_Pigreco expands the range with new tops shapes, such as the trapezoidal black lacquered top, W. 2400 mm with two different depths 1400 and 900 mm. Cable management with black flip-top.

it\_Pigreco arricchisce la gamma con nuove forme dei piani, come il piano trapezoidale, qui nella versione laccato nero L. 2400 mm con due diverse profondità 1400 e 900 mm. Elettrificazione tramite flip-top nero.

fr\_Pigreco élargit la gamme avec de nouvelles formes de plateaux, comme le plateau trapézoïdal ici laqué noir, L. 2400 mm avec deux profondeurs différentes, 1400 et 900 mm. Électrification avec flip-top noir.







en\_Orgatower cabinet serves as integrated storage for those who need to have everything at hand. Available in the low version H. 720 mm or H. 1100 mm, it is also available with an integrated planter box on the top.

it\_I contenitori Orgatower fungono da archiviazione integrata per chi ha bisogno di avere tutto a portata di mano. Disponibili nella versione bassa H. 720 mm o alta H. 1100 mm, possono avere l'opzione di una fioriera integrata nel top.

fr\_Les conteneurs Orgatower servent de stockage intégré pour ceux qui ont besoin d'avoir tout à portée de main. Disponibles dans la version basse H. 720 mm ou haute H. 1100 mm, vous pouvez choisir l'option d'une jardinière intégrée ou dessus.



en\_Single or double-sided modular bookcase, with black uprights and crossbars available in different heights and widths. The bookcase compartments can be equipped with back panels, doors or drawers in different finishes.

it\_Libreria modulare monofacciale o bifacciale, con montanti e traversi neri disponibili in diverse altezze e larghezze. I vani della libreria sono attrezzabili con schiene, ante o cassetti in diverse finiture.

fr\_Bibliothèque modulaire monoface ou double face, avec montants et barres transversales noirs disponibles en différentes hauteurs et largeurs. Les compartiments de la bibliothèque peuvent être équipés de dossiers, portes ou tiroirs de différentes finitions.





en\_There are several solutions proposed for documents storage and personal objects such as mobile, structural pedestals, structural cabinets or personal drawers fixed under the desk top.

it\_Diverse sono le soluzioni proposte per il contenimento di documenti ed oggetti personali come cassettiere su ruote, cassettiere o contenitori strutturali e cassettoni sotto scrivania.

fr\_Plusieurs solutions sont proposées pour l'archivage des documents et objets personnels tels que tiroirs sur roulettes, tiroirs ou conteneurs structurels, petit tiroir plumier.









en\_The lockers are part of the Galaxy collection; designed for storing documents or personal belongings in the workplace. The hinged doors are available in different heights, finishing and different types of locks: standard, mechanical combination, encrypted code or through a badge. Option: mail slot, name tags, number or compartments with power charge.

it\_I lockers fanno parte della collezione Galaxy e sono armadi destinati al contenimento di documenti o di oggetti personali sul posto di lavoro. I lockers sono disponibili in diverse altezze, finiture e diverse tipologie di serratura: standard, a combinazione meccanica, combinazione elettronica o tramite tessera magnetica. In opzione: feritoie, targhetta identificativa, numeri o vani elettrificati.

fr\_Les lockers font partie de la collection Galaxy et sont destinées au rangement de documents ou objets personnels sur le lieu de travail. Les lockers sont disponibles en différentes hauteurs, finitions et différents typologies de serrure: standard, combinaison mécanique, combinaison électronique ou par carte magnétique. En option: fentes, plaque signalétique, numéros ou compartiments électrifiés.



## Ergonomic shapes, green materials

“The wood conglomerate used for the production of the panels falls within the class CARB P2 and meets the standards for the ANSI / BIFMA emissions as established by the LEED certification”



en\_The Pigreco collection is now even more flexible and dynamic. Thanks to the variety of legs, finishes and top sizes, the system is able to adapt to a large number of configurations and different work environments. All the panels are CARB P2 tested.

it\_La collezione Pigreco risulta ad oggi ancora più flessibile e dinamica. Grazie alla varietà di gambe, finiture e dimensioni dei piani, il sistema è in grado di adattarsi a un gran numero di configurazioni e a differenti ambienti di lavoro. Tutti i pannelli utilizzati rientrano nella classe CARB P2.

fr\_La collection Pigreco est désormais encore plus flexible et dynamique. Grâce à la variété des pieds, des finitions et des tailles supérieures, le système est capable de s'adapter à un grand nombre de configurations et à différents environnements de travail. Tous les panneaux sont CARB P2 certifiés.



en\_Pigreco desk with rounded edges top and legs in titanio finish. Nucleo panels in fabric Cat. H 989 Zucca and fabric sofa Cat. M 705 Rosso Chiaro.

it\_Scrivania Pigreco con piano e gambe in finitura titanio. Il piano è stato proposto nella versione angoli arrotondati. Pannelli Nucleo in tessuto Cat. H 989 Zucca, con divano in tessuto Cat. M 705 Rosso Chiaro.

fr\_Bureau Pigreco avec plateau et pieds en finition titanio. Les plateau est proposés dans la version avec coins arrondis. Panneaux Nucleo en tissu Cat. H 989 Zucca et tissu Cat. M 705 Rosso Chiaro.





en\_Desk W. 2000 D. 900 mm with 034 melamine oak top, chrome legs and 041 titanio melamine structural cabinet. Galaxy storage Linear lacquered door 433 Verde Muschio.

it\_Scrivania L. 2000 P. 900 mm con piano melaminico rovere 034, gambe cromo e mobile di servizio strutturale melaminico titanio 041. Contenitore Galaxy anta Linear laccato 433 Verde Muschio.

fr\_Bureau L. 2000 P. 900 mm avec plateau en mélamine chêne 034, pieds chromés et meuble de service porteur en mélamine titanio 041. L'armoire Galaxy porte Linear laqué 433 Verde Muschio.



en\_Structural cabinet W. 1600 D. 550  
H. 610 mm with drawers and door  
available in different finishes.

it\_Contentitore strutturale L. 1600 P. 550  
H. 610 mm con cassetti e anta,  
disponibile in diverse finiture.

fr\_Meuble de service porteur L. 1600 P. 550  
H. 610 mm disponible avec tiroirs et  
porte en différentes finitions.



# Pigreco and the neighborhoods concept in “La Piazza” by Martex

en\_The concept of “Piazza” inspired the design of operative environments similar to small neighborhoods where people work as in small communities, separated but interlinked one to another in an optimal space to foster collaboration and enhance creativity at work.

it\_Il concetto di “Piazza” ha ispirato la progettazione di ambienti operativi simili a piccoli quartieri in cui le persone lavorano come in piccole comunità, separate ma collegate tra loro in uno spazio ottimale per favorire la collaborazione e migliorare la creatività sul lavoro.

fr\_Le concept de “Piazza” a inspiré la conception d’environnements de travail similaires à de petits quartiers où les gens travaillent comme dans de petites communautés, séparés mais liés les uns aux autres, un espace optimal pour favoriser la collaboration et améliorer la créativité au travail.







en\_In addition to a space for well-being, the break area also represents an incredibly prolific meeting place for the exchange of opinions and the creation of new ideas.

it\_Oltre che uno spazio per il benessere, l'area break rappresenta anche un terreno d'incontro incredibilmente fertile per lo scambio di opinioni e la nascita di nuove idee.

fr\_En plus d'un espace de bien-être, l'espace cafétéria représente également un lieu de rencontre incroyablement fertile pour l'échange d'opinions et la naissance de nouvelles idées.



en\_Table available in two depths 800 and 1000 mm  
and in different lengths with and without footrest.  
Stools in finish Cat. L 724 Barbican, 725 Archway  
and Cat. M 705 Rosso Chiaro.

it\_Tavolo disponibile in due profondità 800 e 1000 mm  
e in diverse lunghezze con e senza poggiatesta.  
Sgabelli in finitura Cat. L 724 Barbican, 725 Archway  
e Cat. M 705 Rosso Chiaro.

fr\_Table disponible en deux profondeurs 800 et 1000 mm  
et en différentes longueurs avec et sans repose-pieds.  
Tabourets en finition Cat. L 724 Barbican, 725 Archway  
et Cat. M 705 Rosso Chiaro.







en\_Sofa collection Nucleo W. 4800 mm in fabric  
 Cat. L 727 Temple, black lacquered tables  
 diameter 600 mm and pouf in Cat. L 724 Barbican,  
 725 Archway and Cat. M 705 Rosso Chiaro.

it\_Divanetto collezione Nucleo L. 4800 mm in tessuto  
 Cat. L 727 Temple, tavoli diametro 600 mm  
 laccati neri e pouf in Cat. L 724 Barbican,  
 725 Archway e Cat. M 705 Rosso Chiaro.

fr\_Canapé collection Nucleo L. 4800 mm en tissu  
 Cat. L 727 Temple, tables diamètre 600 mm  
 laqué noir et pouf en Cat. L 724 Barbican,  
 725 Archway et Cat. M 705 Rosso Chiaro.







en\_Bench W. 3600 D. 1600 mm with melamine 030 olmo tops,  
leg Pigreco Loop titanio, screen in fabric  
L. 1600 mm Cat. M 706 Rosso.

it\_Bench L. 3600 P. 1600 mm con piani melaminico  
olmo 030 e gamba Pigreco Loop titanio,  
screen in tessuto L. 1600 mm Cat. M 706 Rosso.

fr\_Bench L. 3600 P. 1600 mm avec plateaux en mélamine  
olmo 030, pied Pigreco Loop en titanio, cloisonnette  
en tissu L. 1600 mm Cat. M 706 Rosso.





en\_There are many possibilities for cable management of desks and meeting tables, from a simple scallop as in the photo below to a more complex solution.

it\_Molteplici sono le possibilità di elettrificare scrivanie e tavoli riunioni, da una semplice scaloppa come nella foto sotto, fino ad prodotti più articolati.

fr\_Il existe de nombreuses possibilités d'électrifier bureaux et tables de réunion, d'une simple escalope comme sur la photo ci-dessous à un articles plus complexes.







en\_Bench W. 4800 D. 800 mm white melamine tops and white structure, with Slim metal drawer unit W. 321 mm.

it\_Bench in linea L. 4800 P. 800 mm piani melaminico bianco, struttura bianca, con cassetteria metallica Slim L. 321 mm.

fr\_Bench L. 4800 P. 800 mm, plateaux en mélaminé blanc, structure blanche, avec caisson en métal Slim L. 321 mm.





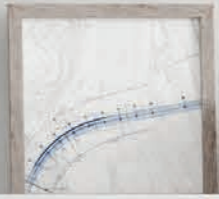
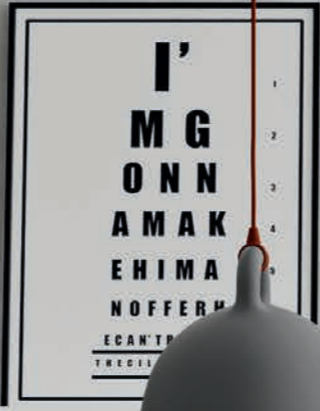

en\_Desk Pigreco Loop leg with white melamine Vertebra storage H. 1629 mm with melamine rovere 034 backs. The desk top is a single top W. 1600 D. 1600 mm with 2 cable port type C.

it\_Pigreco gamba Loop viene qui abbinata a contenitori Vertebra H. 1629 mm in melaminico bianco con schiene in melaminico rovere naturale 034. Il piano della scrivania è un piano unico L. 1600 P. 1600 mm con 2 passacavi tipo C.

fr\_Bureau Pigreco avec pied Loop avec des conteneurs Vertebra H. 1629 mm mélaminé blanc avec dos en mélamine chêne 034. Le bureau est un plateau L. 1600 P. 1600 mm avec 2 obturateurs type C.





en\_The possibility of a third level allows more storage in the workplace. Closed office composition W. 1800 D. 2400 mm with titanio melamine top, olmo edge, titanio structure and titanio lacquered cabinets. Fabric panel Cat. L 724 Barbican.

it\_La possibilità di un terzo livello sul piano di lavoro permette maggiore archiviazione. Composizione closed office L. 1800 P. 2400 mm con piano malaminico titanio bordo olmo, struttura titanio e contenitori in laccato titanio. Pannello in tessuto Cat. L 724 Barbican.

fr\_La possibilité d'un troisième niveau sur la surface de travail permet plus de stockage. Composition bureau L. 1800 P. 2400 mm avec plateau en mélamine titanio, chants en olmo, structure en mélamine titanio et rangements laqués en finition titanio. Cloisonnette en tissu Cat. L 724 Barbican.





en\_Large and functional table for comfortable and elegant meeting rooms. W. 3200 D. 1600 mm table with 034 oak top and 413 Amarena lacquered leg. Electrification on top with flap type Q in top finishing.

it\_Tavolo ampio e funzionale, per confortevoli ed eleganti sale riunioni. Tavolo L. 3200 P. 1600 mm con piano rovere 034 e gamba laccata Amarena 413. Elettificazione sopra piano con passacavo tipo Q in finitura.

fr\_Grande table fonctionnelle pour des salles de réunion confortables et élégantes. Table réunion L. 3200 P. 1600 mm avec plateaux en chêne 034 et pied laqué Amarena 413. Électrification de surface avec flap type Q en finition.





en\_Available in 4 heights and 4 lengths, the bookshelf is composed by black finish aluminum frame. The bookshelf can be equipped with backs panels, side panels, drawers and filing drawers.

it\_Disponibile in 4 altezze e 4 lunghezze la libreria è composta da telai realizzati con profili di alluminio finitura nera. È possibile attrezzare i vani con schiene, fianchi, ante, cassetti e classificatori.

fr\_Disponible en 4 hauteurs et 4 longueurs, la bibliothèque a une structure en aluminium finition noire. Les compartiments peuvent être équipés de dossiers, panneaux latéraux, tiroirs et tiroir dossier.



**Specs sheets**

# Pigreco structure

en\_The Design Concept of Pigreco worked on aesthetics but also on easy assembling and quick installation process that result particularly easy and intuitive. The cable management can be effected when the workstation is completely assembled. We highlight the maximum span of 3600 mm between the side legs.

it\_Il Concept Design di Pigreco ha lavorato sull'estetica, ma anche sulla facilità di montaggio ed assemblaggio che risultano particolarmente semplici ed intuitivi. Il posizionamento dei cavi, che di solito viene eseguito a strutture semiallestite, interrompendo così il lavoro di assemblaggio, può essere effettuato, invece, a bench completamente montati. Si evidenziano la luce massima tra le due gambe fino a 3600 mm.

fr\_Le Concept Design de Pigreco a travaillé sur l'esthétique, mais aussi sur la facilité d'installation et de montage qui sont particulièrement simples et intuitives. Le positionnement des cables, qui a habituellement lieu à des structures partiellement montées en bloquant le travail de montage, peut être effectuée une fois le bench est complètement monté. En évidence le maximum de décalage entre les deux pieds aux extrémités allant jusqu'à 3600 mm.



## Pigreco leg / Gamba Pigreco / Pied Pigreco



en\_Single Leg  
it\_Gamba singola  
fr\_Pied individuel

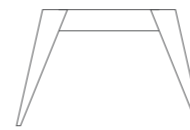
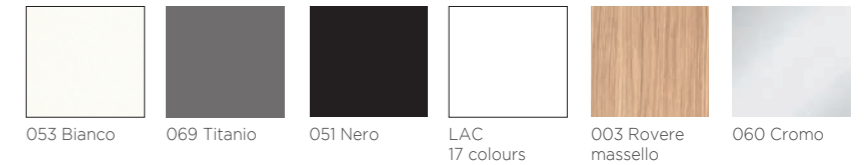

en\_Bridge Leg  
it\_Gamba ponte  
fr\_Pied arche

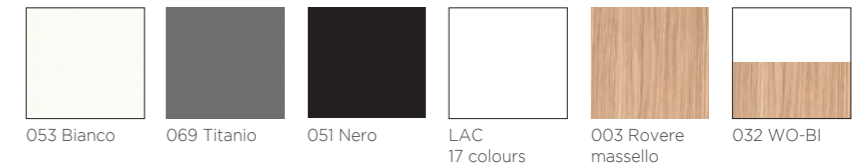

## Pigreco Loop leg / Gamba Loop Pigreco / Pied Pigreco Loop



en\_Desk Leg  
it\_Gamba per scrivania  
fr\_Pied pour bureau



en\_Bench Leg  
it\_Gamba per bench  
fr\_Pied pour bench

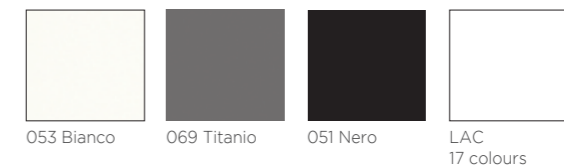

## Leg for high table / Gamba per tavolo alto / Pied pour table haute



800



051 Nero



# Desk

en\_Desks are the essential part of office furniture. Their aesthetic and functional role is the focus in the workspace organization. Available with Pigreco leg or Loop leg, in different sizes, shapes and finishes allow a wide aesthetic and functional choice.

it\_Le scrivanie sono la parte essenziale dell'arredo ufficio. Il loro ruolo estetico e funzionale è un punto chiave nell'organizzazione dello spazio di lavoro. Disponibili con gamba Pigreco o Loop, in diverse dimensioni, forme e finiture permettono un'ampia scelta estetica e funzionale.

fr\_Les bureaux sont la partie essentielle de l'aménagement du bureau, leur rôle esthétique et fonctionnel est un point clé dans l'organisation de l'espace de travail. Disponible avec pied Pigreco ou Loop, en différentes dimensions, formes et finitions permettent un large choix esthétique et fonctionnel.

## Desk with Pigreco Leg / Scrivanie con gamba Pigreco / Bureau avec pied Pigreco

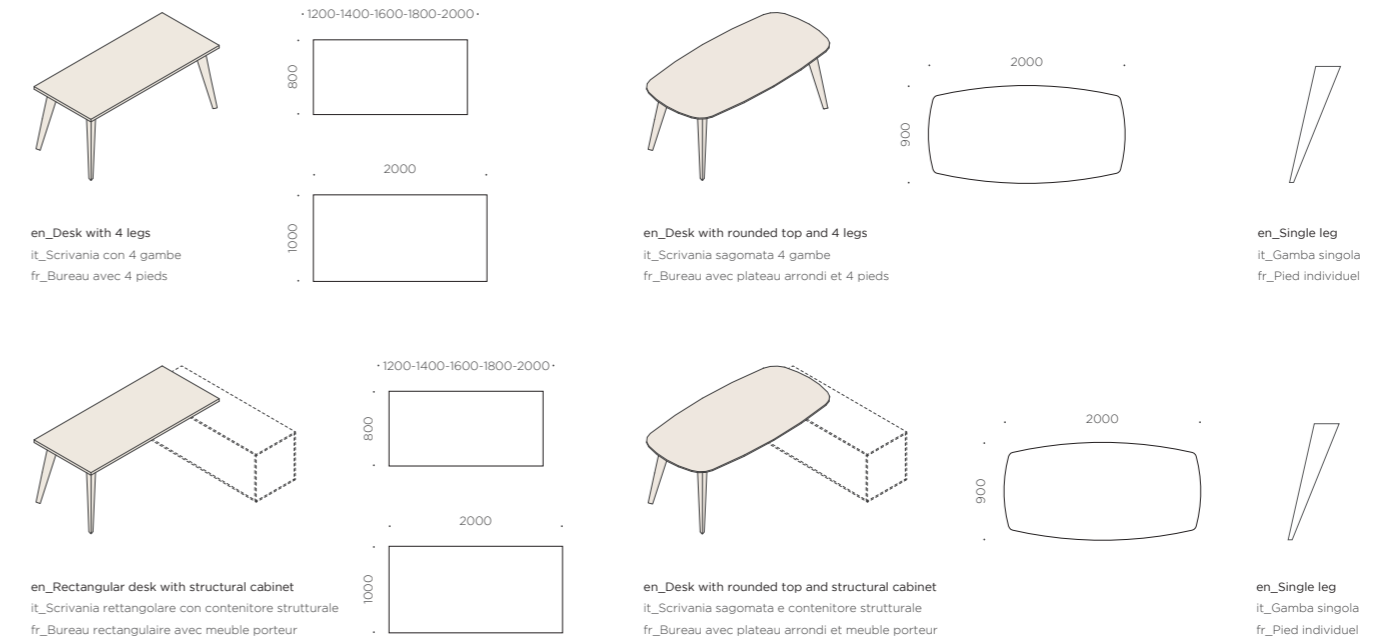

## Desks with Pigreco Loop leg / Scrivanie con gamba Pigreco Loop / Bureau avec pied Pigreco Loop

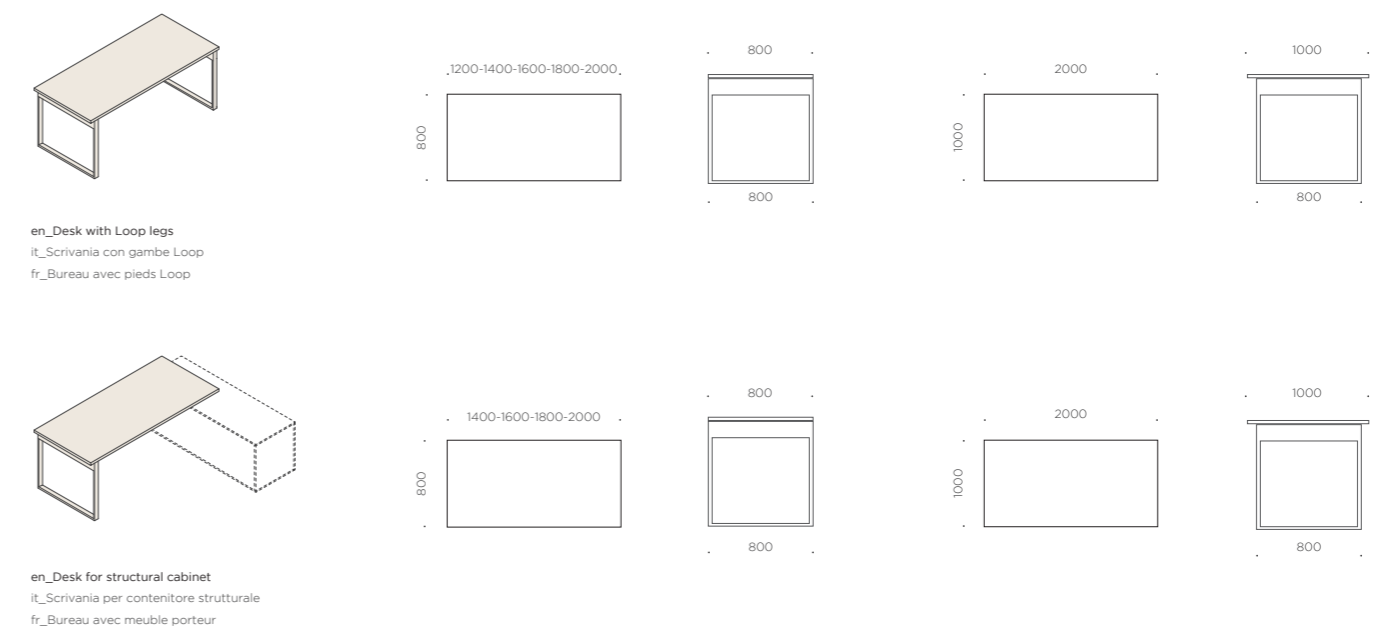

# Bench Pigreco leg

en\_With Pigreco bench it is possible to create compositions up to lengths of 3600 mm without intermediate leg.

it\_Con i bench Pigreco si possono creare composizioni fino a lunghezze di 3600 mm senza gamba intermedia.

fr\_Avec Pigreco composition bench avec longueurs jusqu'à 3600 mm sin pied intermédiaire.

## Bench with single legs / Bench con gamba singola / Bench avec pied individuel

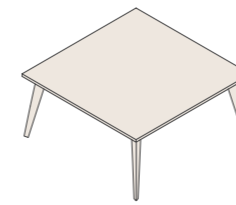

en\_Bench  
it\_Bench  
fr\_Bench

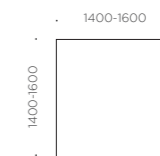
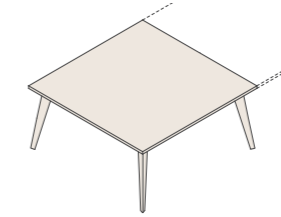

en\_Bench  
it\_Bench  
fr\_Bench



en\_Single leg  
it\_Gamba singola  
fr\_Pied individuel

## Bench with bridge legs / Bench con gamba a ponte / Bench avec piétements arche

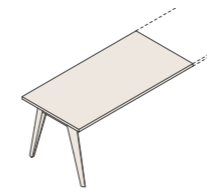

en\_Bench with bridge leg W. 800 mm  
it\_Bench gamba a ponte L. 800 mm  
fr\_Bench avec piétements arche L. 800 mm

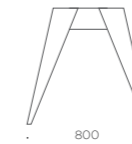

en\_Bridge Leg  
it\_Gamba ponte  
fr\_Piétements arche

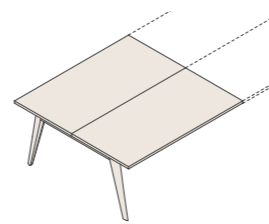

en\_Bench with bridge leg W. 1400 mm  
it\_Bench gamba a ponte L. 1400 mm  
fr\_Bench avec piétements arche L. 1400 mm

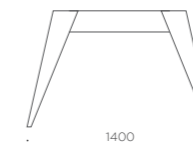

en\_Bridge Leg  
it\_Gamba ponte  
fr\_Piétements arche



# Bench Loop leg

en\_Bench desks are ideal for furnishing open-plan environments or offices where team work is preferred. At any time can be equipped with screen or storage units.

it\_Le scrivanie multiple composte da scrivanie a due posti o più, sono ideali per arredare ambienti open space o uffici in cui si predilige il lavoro di squadra. Le postazioni multiple vengono suddivise grazie a pannelli separatori e necessitano molte volte di un contenimento a bordo scrivania.

fr\_L'exigence la plus grande dans l'organisation des salles opérationnelles est l'ergonomie, unie à l'optimisation de la place en relation aux fonctions. Cette section comprend: bureaux opérationnels individuels, bench, systèmes avec station centrale, cloisons de séparation.

## Bench / Bench / Bench

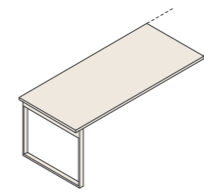

en\_Bench Loop legs  
it\_Bench gamba Loop  
fr\_Bench pied Loop

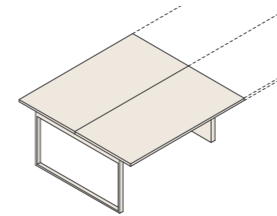
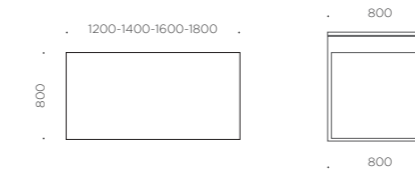

en\_Bench Loop legs  
it\_Bench gamba Loop  
fr\_Bench pied Loop

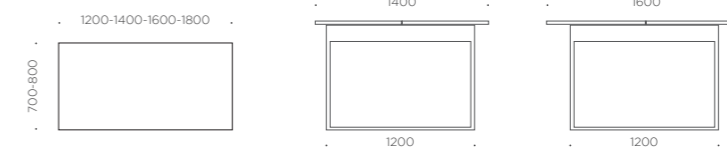

# Screen

en\_In open space areas, screen partitions for desks are very useful for dividing workstations and ensuring the privacy of those who use them. They can be in wood or upholstered in fabric, and can be equipped with accessory bars as paper trays, pen holders or monitor holders.

it\_Nelle aree open space, i pannelli divisori per scrivanie sono molto utili per dividere le postazioni e garantire la privacy di chi le utilizza. Possono essere in legno o rivestiti in tessuto e possono essere attrezzati con barre per aggancio di vaschette portadocumenti, portapenne o portamonitor.

fr\_Dans les zones à espace ouvert, les cloisonnettes de séparation pour bureaux sont très utiles pour séparer les postes de travail et garantir l'intimité de ceux qui les utilisent. Ceux-ci peuvent être en bois ou revêtus en tissu ou peuvent être équipés avec des barres pour accrocher des porte-documents, des porte-crayons ou des porte-écrans.



## Front screen / Screen frontali / Cloisonnette frontale

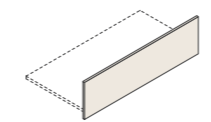

en\_Screen th. 18 mm for single desk  
it\_Screen sp. 18 mm per scrivania singola  
fr\_Cloisonnette ép. 18 mm pour bureau

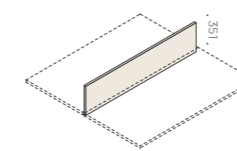

en\_Screen for bench sp. 18 mm  
it\_Screen per bench sp. 18 mm  
fr\_Cloisonnette ép. 18 mm pour bench

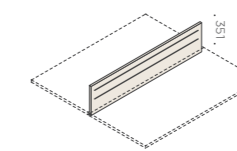
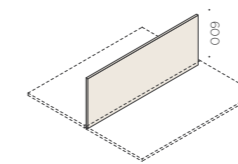

en\_Screen th. 30 mm for bench  
it\_Screen sp. 30 mm per bench  
fr\_Cloisonnette ép. 30 mm pour bench

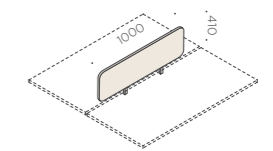

en\_Nucleo screen for bench  
it\_Screen Nucleo per bench  
fr\_Cloisonnette Nucleo pour bench

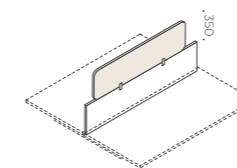

en\_Screen extension  
it\_Divisorio sopra screen  
fr\_Rehausse pour cloisonnette

## Screen laterale / Lateral screen / Cloisonnette latérale

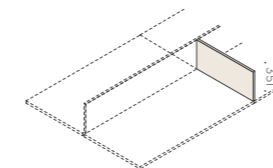

en\_Fixed screen th. 18 mm  
it\_Screen fisso sp. 18 mm  
fr\_Cloisonnette fixe ép. 18 mm

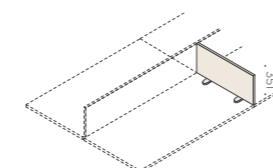
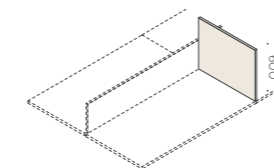

en\_Screen freestanding th. 18 mm  
it\_Screen freestanding sp. 18 mm  
fr\_Cloisonnette laterale freestanding ép. 18 mm

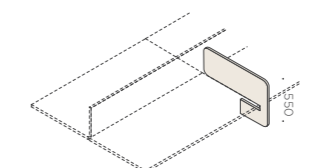
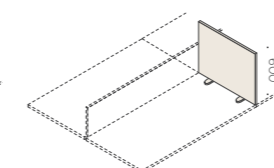

en\_Movable screen  
it\_Screen Movable  
fr\_Cloisonnette Movable

# Meeting table Pigreco leg

en\_The rigor of the wide span without supports transmits a sense of order and clean lines, and gives the space a strong and unique personality.  
Small meeting areas can be elegantly furnished, in addition to the classic round or square tables, with new functional shapes with the rounded shaped table top.

it\_Il rigore dell'ampia campata senza sostegni a terra trasmette ordine e pulizia formale e dona all'ambiente una personalità forte ed esclusiva.  
Le piccole aree riunioni oltre ai classici tavoli rotondi o quadrati, possono essere finemente arredate con le nuove funzionali geometrie dei tavoli sagomati.

fr\_La rigueur de la grande poutre sans pied intermédiaire transmet ordre et propreté et donne à l'environnement une personnalité forte et exclusive.  
Les petites zones réunions peuvent être aménagée, en plus des tables rondes ou carrées classiques, avec les nouvelles géométries de la table avec plateau arrondi.



## Meeting table with 4 legs / Tavoli riunione con 4 gambe / Table de réunion avec 4 pieds

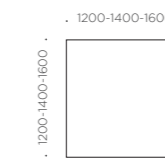
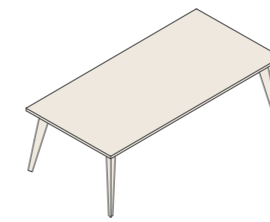

en\_Meeting tables with 4 legs  
it\_Tavolo riunioni con 4 gambe  
fr\_Table réunion avec 4 pieds



en\_Single Leg  
it\_Gamba singola  
fr\_Pied individuel

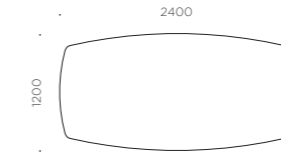

en\_Meeting table with rounded top and 4 legs  
it\_Tavolo riunioni sagomato 4 gambe  
fr\_Table réunion avec plateau arrondi et 4 pieds



en\_Single Leg  
it\_Gamba singola  
fr\_Pied individuel

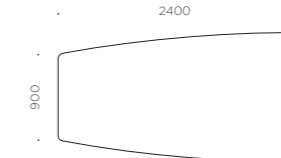
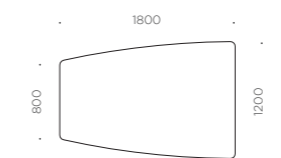
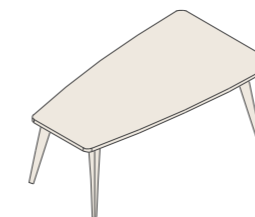

en\_Meeting table with trapezoidal top and 4 legs  
it\_Tavolo riunioni trapezoidale 4 gambe  
fr\_Table réunion avec plateau trapézoïdale et 4 pieds



en\_Single Leg  
it\_Gamba singola  
fr\_Pied individuel

## Meeting table with bridge legs / Tavoli riunione con gamba a ponte / Table de réunion avec piétements arche

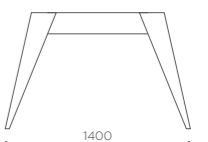
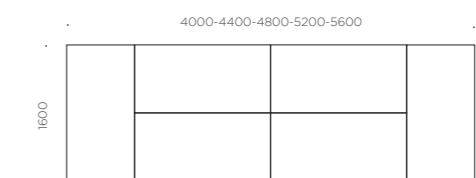
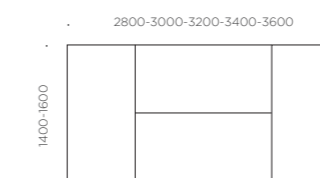
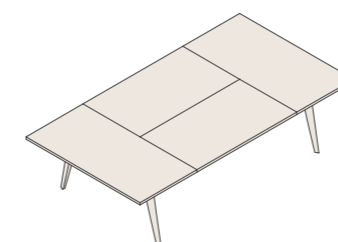

en\_Meeting table with bridge leg  
it\_Tavolo riunione gamba a ponte  
fr\_Table de réunion avec piétements arche

en\_Bridge Leg  
it\_Gamba ponte  
fr\_Piétements arche

# Meeting table Loop leg and High Table

en\_In the office environment areas where people can meet and work together, such as meeting rooms and common areas where people can relax, and communicate, are increasingly important. In these spaces, in addition to solutions with meeting tables with a classic design, high tables can be proposed to facilitate socialization among people.

it\_Sempre di più nell'ambiente ufficio sono importanti le aree dove le persone si possano incontrare e lavorare insieme, come le sale meeting e aree comuni dove le persone possono rilassarsi, comunicare, fare pause. In questi spazi oltre a soluzioni con tavoli riunioni dalla classica conformazione, si possono proporre tavoli alti che facilitano la socializzazione tra le persone.

fr\_Dans l'environnement de bureau, les espaces où les gens peuvent se rencontrer et travailler ensemble, sont de plus en plus importants; salles de réunion et espaces communs où les gens peuvent se détendre, communiquer et faire des pauses. Dans ces espaces, en plus des solutions avec des tables de réunion au design classique, des tables hautes peuvent être proposées pour faciliter la socialisation.



## Meeting table / Tavoli riunione / Table de réunion

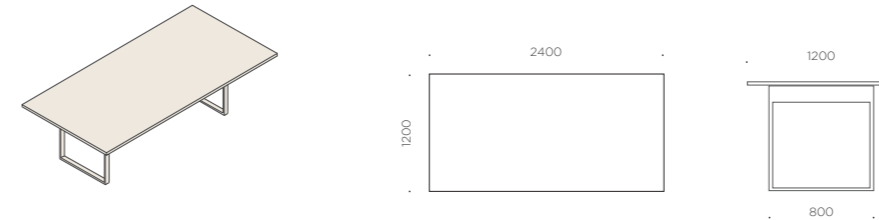

en\_Meeting table  
it\_Tavolo riunione  
fr\_Table de réunion

## Meeting table / Tavolo riunione / Table de réunion

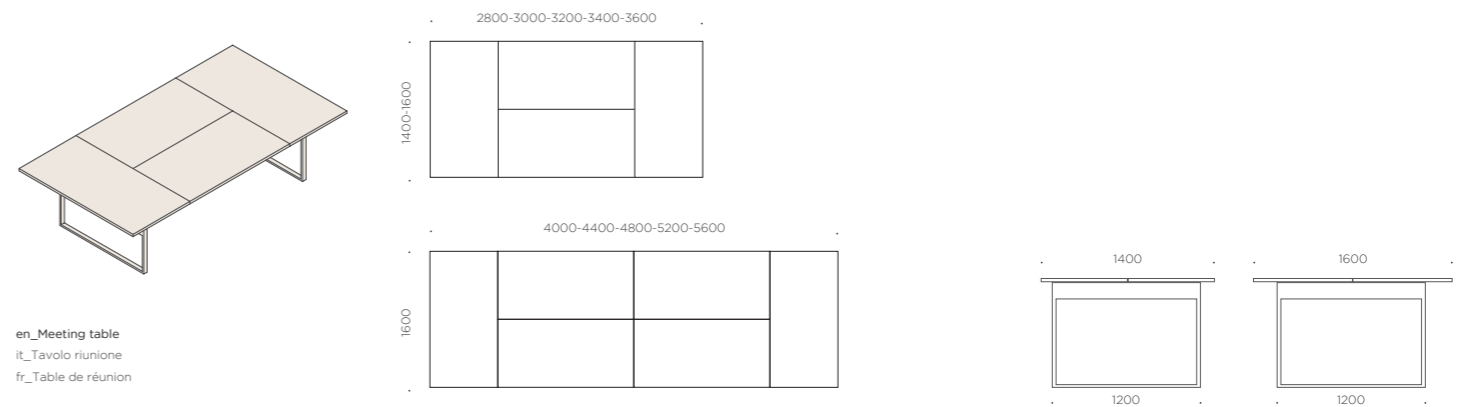

en\_Meeting table  
it\_Tavolo riunione  
fr\_Table de réunion

## High table / Tavolo alto / Table haute

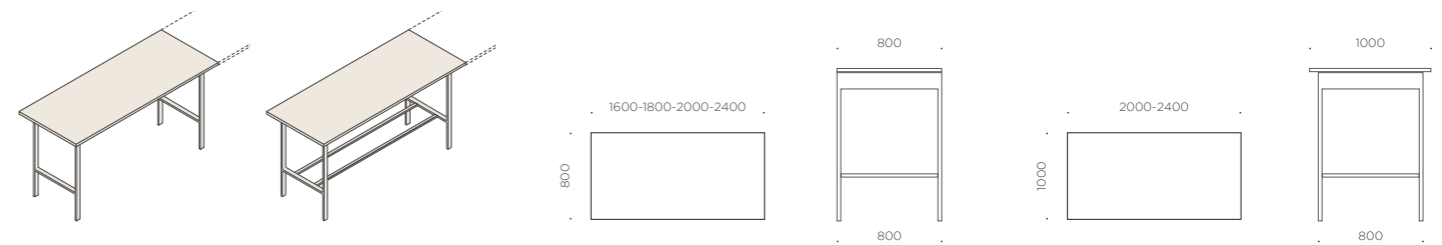

en\_High table  
it\_Tavolo alto  
fr\_Table haute

en\_High table with footrest  
it\_Tavolo alto con poggiatesta  
fr\_Table haute avec repose-pieds

# Pedestals and desk storage

en\_Mobile or fixed office pedestal with drawers or filing drawers, in melamine or metal, single or double sided, represent a universe of offers that select the solution that best suit the requirements. All the office pedestals have centralized locking system with different encrypted lock.

it\_Cassettiere per ufficio nomadi e fisse, con cassetti o classificatori, in melaminico o metallo, mono e bifacciali, rappresentano un universo di proposte che consentono di scegliere la soluzione che meglio si adatta alle proprie necessità.

fr\_Les meubles à tiroirs mobiles et fixes, avec tiroirs ou classeurs, en mélaminé ou métal, à une ou deux faces, représentent un univers de propositions permettant de choisir la solution qui s'adapte le mieux à ses propres nécessités.

## Metal Pedestals / Cassettiere metaliche / Caissons métal

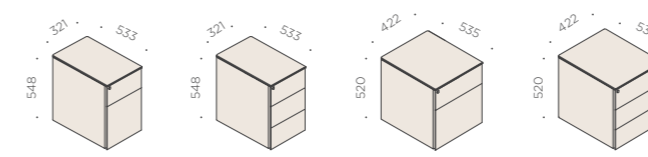

en\_Metal pedestal on castors  
it\_Cassettiere in metallo su ruote  
fr\_Caisson métalliques sur roulettes

## Melamine Pedestals / Cassettiere melaminiche / Caissons mélaminé

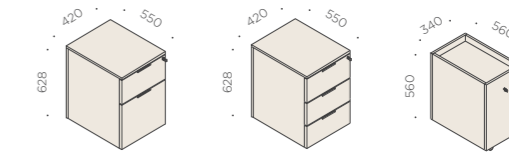

en\_Melamine pedestal on castors  
it\_Cassettiere melaminica su ruote  
fr\_Caisson mélaminé sur roulettes

## Structural cabinet / Contenitore strutturale / Meuble porteur

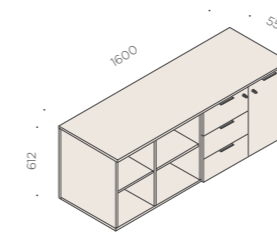

en\_Structural cabinet  
it\_Contenitore strutturale  
fr\_Meuble porteur

## Side cabinet / Contenitori laterali / Meuble latéral

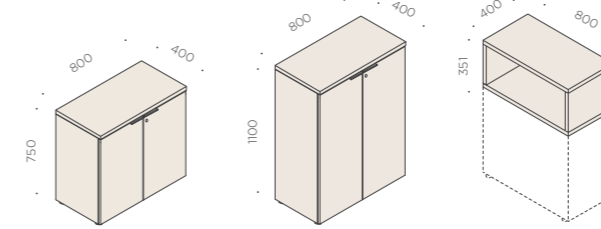

en\_Side cabinet  
it\_Contenitore laterale  
fr\_Meuble latéral

en\_Side cabinet  
it\_Contenitore laterale  
fr\_Meuble latéral

en\_Open box  
it\_Box a giorno  
fr\_Niche ouverte

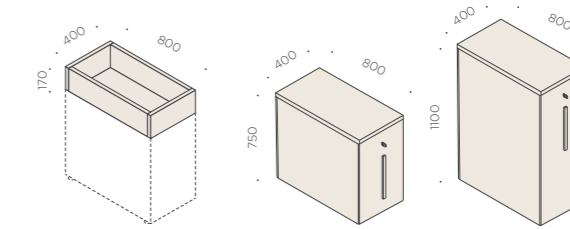

en\_Planter box  
it\_Fioriera  
fr\_Pot à fleurs

en\_Low Orgatower  
it\_Orgatower basso  
fr\_Orgatower basse

en\_High Orgatower  
it\_Orgatower alto  
fr\_Orgatower haut



# Bookshelf

en\_Martex bookshelf is available in 3 heights and 3 widths and can be floor standing or wall mounted.

it\_La Libreria di Martex con mensole e colonne può essere a terra o appesa disponibile in 3 altezze e 3 lunghezze.

fr\_La bibliothèque de Martex avec étagères et colonnes peut être posée au sol ou suspendue. Disponible en 3 hauteurs et 3 longueurs.

## Floor standing bookshelf with shelves / Libreria a terra con mensole / Bibliothèque au sol avec étagères

en\_Options: sides, backs  
it\_Opzioni: fianchi, schiene  
fr\_Options: côtés, dos

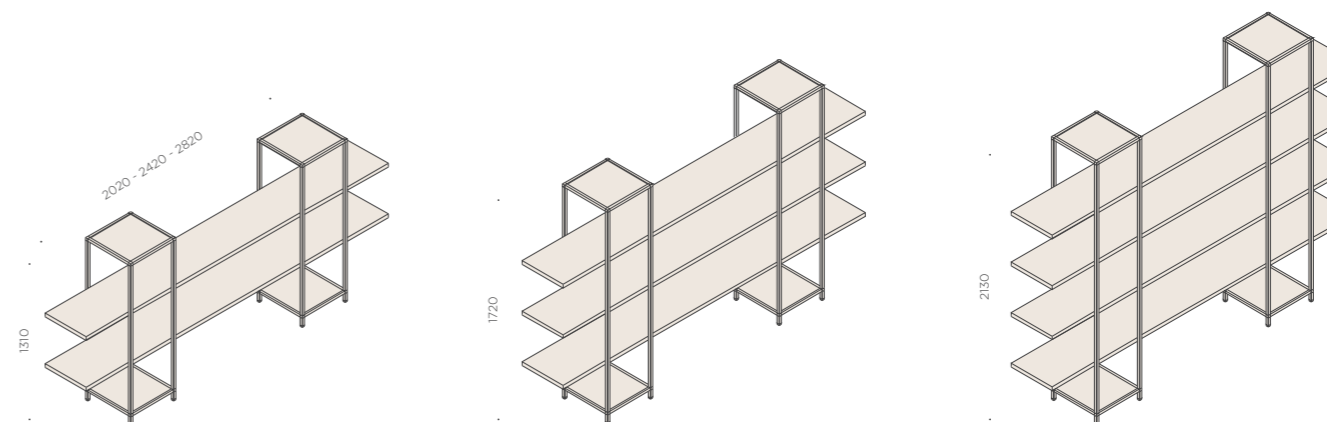

## Wall mounted bookshelf with shelves / Libreria appesa con mensole / Bibliothèque suspendues avec étagères

en\_Options: sides, backs  
it\_Opzioni: fianchi, schiene  
fr\_Options: côtés, dos

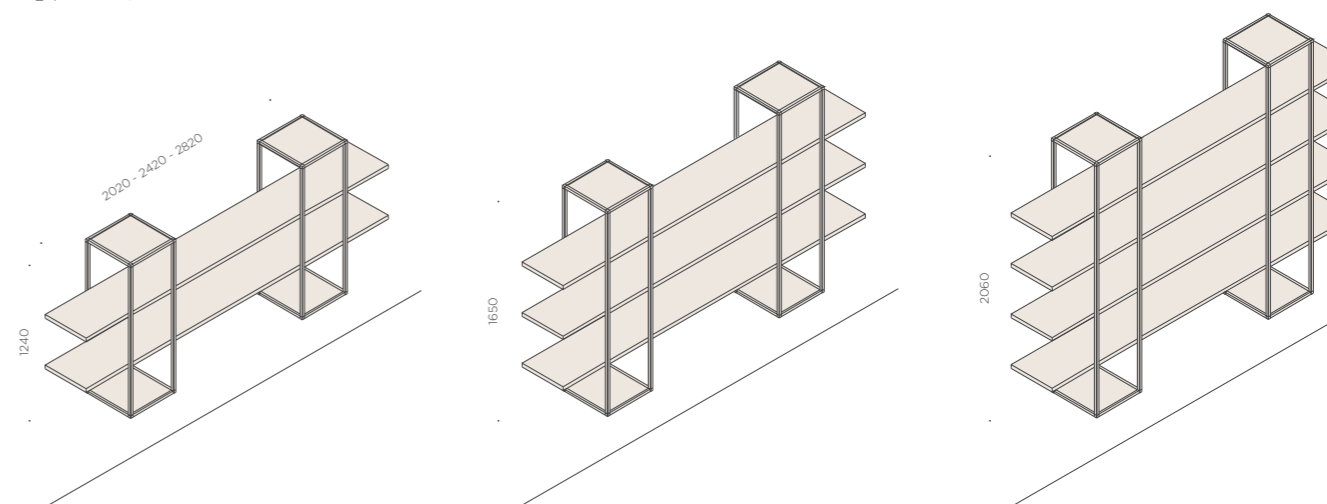



# Modular Bookshelf

en\_Modular bookshelf by Martex is a versatile system composed by a metal frame, where shelves, backs, drawers, doors, planter box, cushions and TV module can be added.

it\_La Libreria modulare di Martex è un sistema versatile costituito da un telaio metallico, a cui possono essere aggiunti ripiani, schiene, cassetti, cestoni, ante, fioriere, cuscini e vani porta tv.

fr\_La bibliothèque modulaire de Martex est un système polyvalent composé d'un cadre en métal, auquel peuvent être ajoutées des étagères, dossiers, tiroirs, portes, pot à fleurs, coussins et module pour téléviseur.



## Modular floor bookshelf / Libreria componibile a terra / Bibliothèque modulaire au sol

en\_Options: portes, côtés, dossiers, 2 tiroirs + 1 tiroir  
 it\_Opzioni: ante, fianchi, schiene, 2 cassetti + 1 cassettona  
 fr\_Options: portes, côtés, dossiers, 2 tiroirs + 1 tiroir

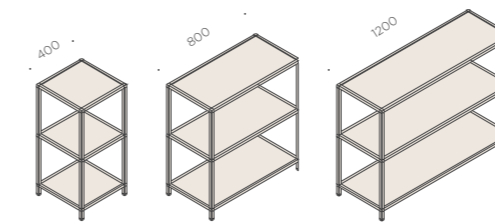

en\_Module widths  
 it\_Larghezze moduli  
 fr\_Largeurs de module

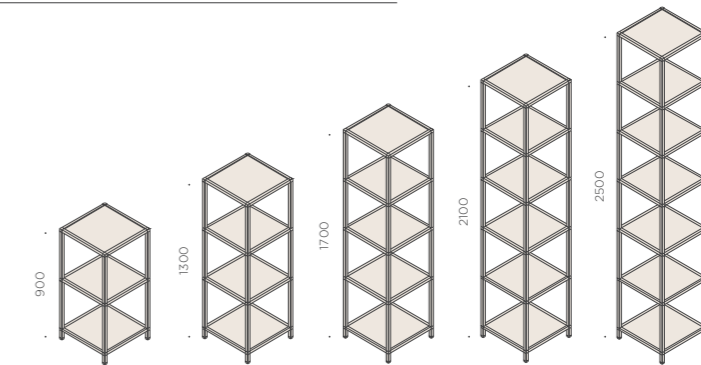

en\_Module height  
 it\_Altezze moduli  
 fr\_Hauteur du module

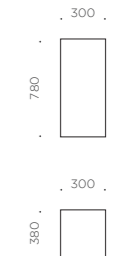

en\_Compartment  
 it\_Vani  
 fr\_Espace de rangement

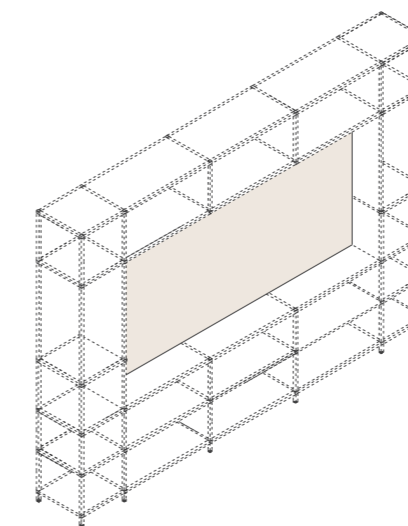

en\_TV module  
 it\_Modulo porta TV  
 fr\_Module meuble TV

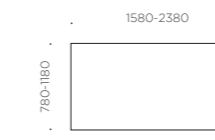

en\_TV module  
 it\_Modulo porta TV  
 fr\_Module meuble TV



en\_TV module electrification  
 it\_Elettificazione modulo porta TV  
 fr\_Electrification du module meuble TV

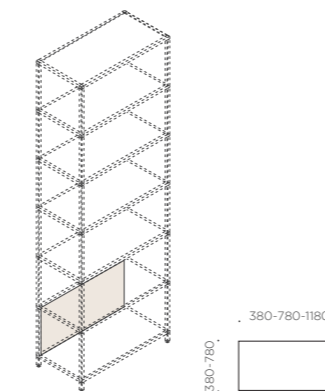

en\_Back  
 it\_Schiena  
 fr\_Dos

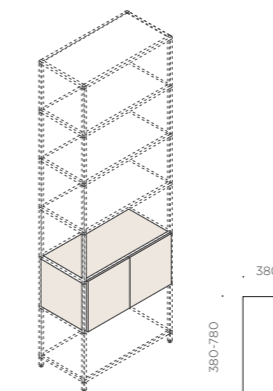

en\_Doors  
 it\_Ante  
 fr\_Portes

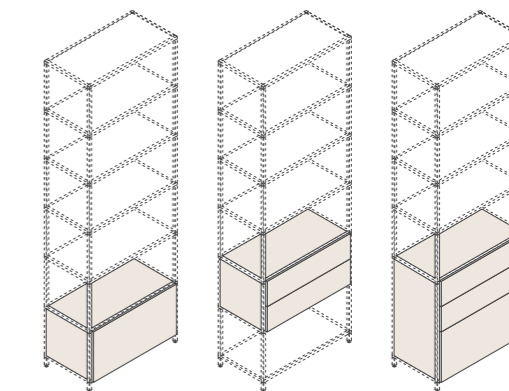

en\_Drawers  
 it\_Cassetti  
 fr\_Tiroirs

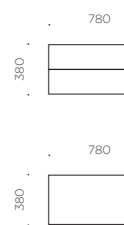

# Wire management

en\_There are several solutions proposed to better electrify desks and tables meetings so that the workstations remain clean and with easy access to power.

it\_Diverse sono le soluzioni proposte per elettrificare al meglio scrivanie e tavoli riunioni in modo che le postazioni risultino pulite e con un agevole accesso alle prese elettriche.

fr\_Plusieurs solutions sont proposées pour mieux électrifier les bureaux et les tables réunions afin que les postes de travail soient propres et avec un accès facile aux prises électriques.



## Pigreco / Pigreco / Pigreco



en\_Cable raise through Pigreco leg and leg cover  
it\_Carter per salita cavi su gamba Pigreco  
fr\_Cache câbles pour remontée dans le pied Pigreco

## Salita cavi per bench o tavolo riunioni / Salita cavi per bench e tavolo riunioni / Remontée des câbles por bench et tables réunion



en\_Central metal box (not structural)  
it\_Colonna elettrificabile in metallo (non strutturale)  
fr\_Colonne en métal (non structurel)



en\_Central structural cable tower upholstered in technical fabric  
it\_Gamba strutturale centrale elettrificabile rivestita in tessuto tecnico  
fr\_Pied central structurel électrifiable revêtu en tissu technique



en\_Central structural cable tower upholstered in technical fabric  
it\_Gamba strutturale centrale elettrificabile rivestita in tessuto tecnico  
fr\_Pied central structurel électrifiable revêtu en tissu technique

## Elettrificazione sopra piano / Elettrificazione sopra piano / Câblage au-dessus du plateau



en\_Cable port type C  
it\_Passacavo tipo C  
fr\_Top access type C



en\_Flipper  
it\_Flipper  
fr\_Flipper



en\_Flap in top finishing type Q  
it\_Sportello in finitura tipo Q  
fr\_Top access en finition type Q



en\_Scallop  
it\_Scaloppa  
fr\_Échancrure



en\_Flip top  
it\_Flip top  
fr\_Flip top

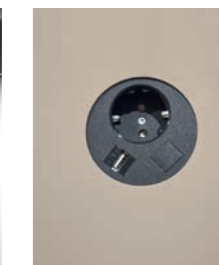

en\_Cable port type I  
it\_Passacavo tipo I  
fr\_Prise type I

# Finishings

en\_Colours for reference only and may vary from original. Fabrics and leathers from different lots may be subject to colour variations. Any differences will not be recognized as a complaint.

it\_Campioni colore indicativi, possono differire dall'originale. Tessuti e pelli possono essere soggetti a cambiamenti e a differenze tra lotti diversi. Eventuali differenze non verranno riconosciute come reclamo.

fr\_Echantillons de coloris indicatifs, ils peuvent différer de l'original. Tissu et cuir de différents lots peuvent être soumis à des changements et à des différences de couleur. Les éventuelles différences ne seront pas reconnus comme une grief.

## MEL - MELAMINE / MELAMINICI / MÉLAMINE

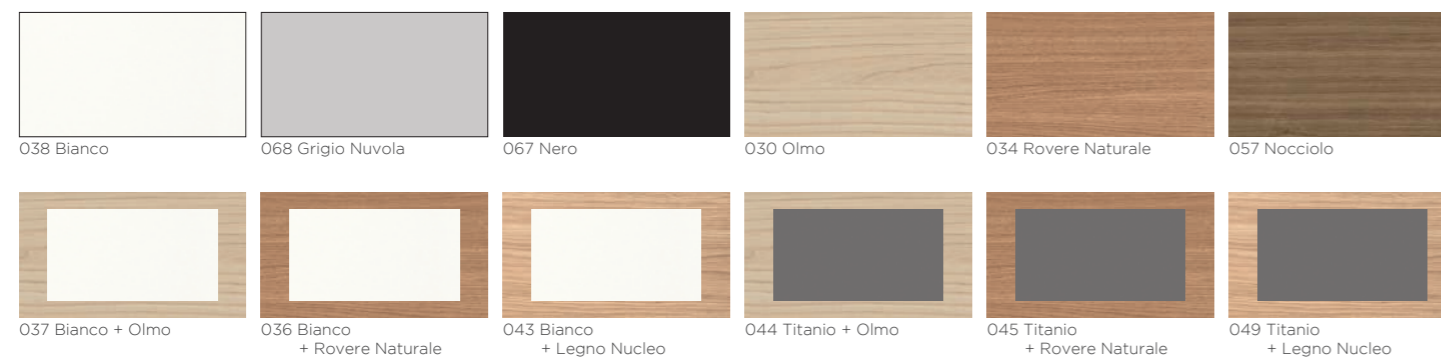

## LAC - MATT LACQUERED COLOURS / LACCATI OPACHI / LAQUÉ MAT



## CAT. C - FABRIC TIME / TESSUTO TIME / TISSU TIME



## CAT. D - FABRIC JET / TESSUTO JET / TISSU JET

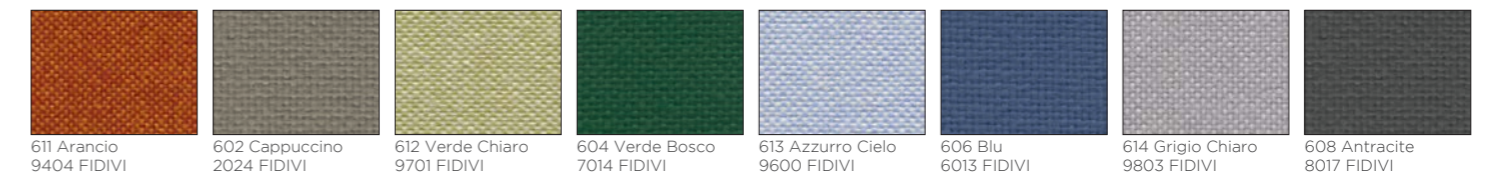

## CAT. I - FABRIC FOCUS MELANGE / TESSUTO FOCUS MELANGE / TISSU FOCUS MELANGE

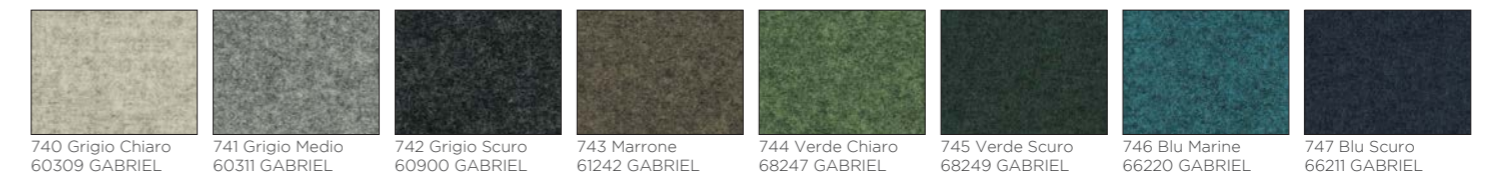

## CAT. I - FABRIC CAPTURE / TESSUTO CAPTURE / TISSU CAPTURE



## CAT. L - FABRIC MAIN LINE FLAX / TESSUTO MAIN LINE FLAX / TISSU MAIN LINE FLAX

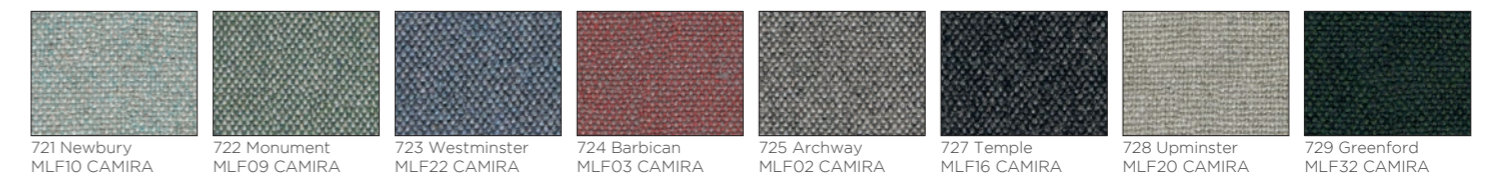

## CAT. L - FABRIC SFERA / TESSUTO SFERA / TISSU SFERA

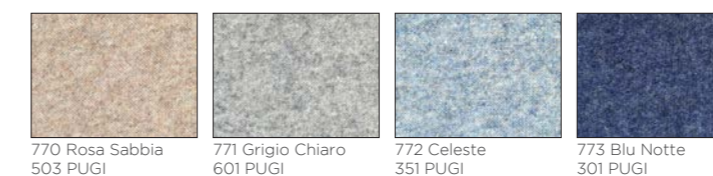

© Copyright 2020 Martex S.p.A. Prata di Pordenone (PN) - Italy. All rights reserved.

Confidential material of relevant economic value, property of Martex S.p.A. Reproduction and/or disclosure, even partial, to third parties is prohibited without specific written authorisation from Martex management.

Martex reserves the rights at all time to apply modifications for the functional or qualitative improvement of its products. Texts and drawings present in this brochure have a divulgative purpose: for every technical and dimensional aspect please refer to the company's price lists and their relative updates. The colour and material samples have an indicative value.

© Copyright 2020 Martex S.p.A. Prata di Pordenone (PN) - Italia. Tutti i diritti riservati.

Materiale riservato di rilevante valore economico, di proprietà della Martex S.p.A. Vietata la riproduzione e/o divulgazione anche parziale a terzi senza autorizzazione scritta specifica della direzione Martex.

Martex si riserva il diritto di apportare, senza preavviso, ogni modifica mirata al miglioramento funzionale e qualitativo dei propri prodotti. Testi e disegni presenti in questo stampato hanno scopo divulgativo: per ogni aspetto tecnico e dimensionale fare riferimento ai listini aziendali e relativi aggiornamenti. I campioni di colori e materiali hanno valore indicativo.

© Copyright 2020 Martex S.p.A. Prata di Pordenone (PN) - Italie. Tous les droits sont réservés.

Matériel confidentiel de valeur économique considérable, propriété de Martex S.p.A. Ne pas reproduire et/ou divulguer, même partiellement, à des tiers sans autorisation écrite spécifique de la direction de Martex.

Martex se réserve à tout moment le droit d'appliquer des modifications pour l'amélioration fonctionnelle ou qualitative de ses produits. Les textes et les dessins présents dans cette brochure ont un but informatif : pour chaque aspect technique et dimensionnel, veuillez-vous référer aux tarifs de la société et à leurs mises à jour. Les échantillons de couleurs et de matériaux ont une valeur indicative.

#### CREDITS

Concept: Studio Monica Graffeo

Graphics: MKT Martex

Photo & Render: Gabriotti Fotografi

Render: PubblCom di Antonio Mosele

Art Buyer: Carla Bernardis

Print: Grafiche Antiga

Photolitho: Lucegroup

SI RINGRAZIA

Atelier Areti

3F Filippi

June 2020\_Rev2

Martex is certified

UNI EN ISO 9001:2015

UNI EN ISO 14001:2015

Martex S.p.A.

via Sagré, 19 - 33080

Prata di Pordenone (PN) Italy

tel +39 0434 602310

fax +39 0434 602319

[info@martex.it](mailto:info@martex.it)

[www.martex.it](http://www.martex.it)

